

FLUKE®

Ti20

Thermal Imager

Users Manual

LIMITED WARRANTY AND LIMITATION OF LIABILITY

Each Fluke product is warranted to be free from defects in material and workmanship under normal use and service. The warranty period is one year and begins on the date of shipment. Parts, product repairs, and services are warranted for 90 days. This warranty extends only to the original buyer or end-user customer of a Fluke authorized reseller, and does not apply to fuses, disposable batteries, or to any product which, in Fluke's opinion, has been misused, altered, neglected, contaminated, or damaged by accident or abnormal conditions of operation or handling. Fluke warrants that software will operate substantially in accordance with its functional specifications for 90 days and that it has been properly recorded on non-defective media. Fluke does not warrant that software will be error free or operate without interruption.

Fluke authorized resellers shall extend this warranty on new and unused products to end-user customers only but have no authority to extend a greater or different warranty on behalf of Fluke. Warranty support is available only if product is purchased through a Fluke authorized sales outlet or Buyer has paid the applicable international price. Fluke reserves the right to invoice Buyer for importation costs of repair/replacement parts when product purchased in one country is submitted for repair in another country.

Fluke's warranty obligation is limited, at Fluke's option, to refund of the purchase price, free of charge repair, or replacement of a defective product which is returned to a Fluke authorized service center within the warranty period.

To obtain warranty service, contact your nearest Fluke authorized service center to obtain return authorization information, then send the product to that service center, with a description of the difficulty, postage and insurance prepaid (FOB Destination). Fluke assumes no risk for damage in transit. Following warranty repair, the product will be returned to Buyer, transportation prepaid (FOB Destination). If Fluke determines that failure was caused by neglect, misuse, contamination, alteration, accident, or abnormal condition of operation or handling, including overvoltage failures caused by use outside the product's specified rating, or normal wear and tear of mechanical components, Fluke will provide an estimate of repair costs and obtain authorization before commencing the work. Following repair, the product will be returned to the Buyer transportation prepaid and the Buyer will be billed for the repair and return transportation charges (FOB Shipping Point).

THIS WARRANTY IS BUYER'S SOLE AND EXCLUSIVE REMEDY AND IS IN LIEU OF ALL OTHER WARRANTIES, EXPRESS OR IMPLIED, INCLUDING BUT NOT LIMITED TO ANY IMPLIED WARRANTY OF MERCHANTABILITY OR FITNESS FOR A PARTICULAR PURPOSE. FLUKE SHALL NOT BE LIABLE FOR ANY SPECIAL, INDIRECT, INCIDENTAL, OR CONSEQUENTIAL DAMAGES OR LOSSES, INCLUDING LOSS OF DATA, ARISING FROM ANY CAUSE OR THEORY.

Since some countries or states do not allow limitation of the term of an implied warranty, or exclusion or limitation of incidental or consequential damages, the limitations and exclusions of this warranty may not apply to every buyer. If any provision of this Warranty is held invalid or unenforceable by a court or other decision-maker of competent jurisdiction, such holding will not affect the validity or enforceability of any other provision.

Fluke Corporation
P.O. Box 9090
Everett, WA 98206-9090
U.S.A.

Fluke Europe B.V.
P.O. Box 1186
5602 BD Eindhoven
The Netherlands

Table of Contents

Chapter	Title	Page
1	Getting Started	1-1
	Introduction.....	1-1
	Contacting Fluke.....	1-1
	Safety Information	1-2
	Laser Warning Labels.....	1-3
	Unpacking the Imager.....	1-4
	Features and Controls	1-6
	Operating the Controls.....	1-7
	Focusing the Imager	1-7
	Understanding the Trigger.....	1-8
	Using the AC Power Adapter	1-9
	Charging and Replacing the Batteries.....	1-10
	Using the Battery Charger.....	1-10
	Installing or Replacing the Batteries	1-11
	Attaching the Wrist Strap	1-12
	Inputs and Connections.....	1-13
	Connecting the USB Cable.....	1-13
	Mounting the Imager on a Tripod.....	1-14
	Cleaning.....	1-14
	Cleaning the Case	1-14
	Cleaning the Lens	1-15
2	Basic Operation.....	2-1
	Turning the Imager On and Off	2-1
	Understanding the Home Display	2-2
	Aiming and Activating the Laser.....	2-4
	Capturing Images.....	2-5
	Comparing Frozen Images to Stored Images.....	2-5
	Adjusting the Backlight	2-6
	Setting the Temperature Scale	2-7
	Setting the Level	2-7
	Adjusting the Span.....	2-9
	Manually Activating the Calibration Flag	2-9
	Using Distance to Spot Size Ratio (D:S).....	2-9

Environmental Conditions	2-11
Ambient Temperature Derating and Thermal Shock	2-11
Emissivity	2-12
Reflected Temperature Compensation.....	2-13
3 Advanced Imager Operation.....	3-1
Data Management and Storage	3-1
Viewing Stored Images	3-1
Deleting Images.....	3-2
Selecting a Palette.....	3-3
Adjusting Emissivity.....	3-4
Adjusting Reflected Temperature Compensation Values	3-6
Setting Alarm Limits	3-7
Adjusting Sleep Mode	3-9
Appendices	
A Glossary.....	A-1
B Basics of Infrared Measurement.....	B-1
C Typical Emissivity Values.....	C-1
D Specifications	D-1

List of Tables

Table	Title	Page
1-1.	Symbols.....	1-2
1-1.	Standard Accessories	1-5
1-3.	Features and Controls.....	1-7
2-1.	Contents of the Home Display	2-3
C-1.	Emissivity Values for Metals	C-2
C-2.	Emissivity Values for Non-Metals.....	C-4

List of Figures

Figure	Title	Page
1-1.	Laser Warning Labels	1-3
1-2.	Standard Accessories	1-4
1-3.	Ti20 Thermal Imager Features and Controls	1-6
1-4.	Focusing the Imager	1-8
1-5.	Using the AC Power Adapter	1-9
1-6.	Using the Battery Charger	1-10
1-7.	Replacing the Battery Pack	1-11
1-8.	Attaching the Wrist Strap	1-12
1-9.	Connecting Using the USB Cable	1-13
1-10.	Mounting the Imager on a Tripod	1-14
2-1.	Imager Splash Screen	2-1
2-2.	Imager home Display Zones	2-2
2-3.	Relationship Between FOV and Measurement Spot and Reticle	2-10
2-4.	Correct Field of View	2-11
2-5.	Reflected Temperature Compensation	2-14
B-1.	Infrared Measurement Region	B-2

Chapter 1

Getting Started

Introduction

The Fluke Ti20 Imager (hereafter, “the Imager”) is a state-of-the-art, lightweight, pistol-grip style thermal imaging unit. Using the Imager, you can obtain instant and accurate thermal images and radiometric readings from distant targets. The Imager is ergonomically designed for right-hand or left-hand use, and captures thermal images and data with a simple trigger press. The Imager can store up to 50 images that can be downloaded to your personal computer for storage, analysis, and report preparation.

The InsideIR companion software application, lets you display, examine, and analyze your images and data to determine qualitative and quantitative trends associated with the target equipment. You can also use InsideIR to define maintenance databases based on your equipment conditions, monitoring, and asset management needs.

The Imager provides high performance thermal imaging and is designed for industrial use. The Ti20:

- Uses new detection technology to provide a clear thermal image with accurate temperature measurements up to 350 °C (662 °F).
- Is protected against dust and moisture (IP54 rated) for use in harsh industrial environments.
- Provides a minimum of 3 hours of continuous battery life.

Contacting Fluke

To contact Fluke, call:

1-888-993-5853 in USA

1-800-363-5853 in Canada

+31-402-675-200 in Europe

+81-3-3434-0181 in Japan

+65-738-5655 in Singapore

+1-425-446-5500 from anywhere in the world

Or, visit Fluke’s Web site at www.fluke.com

To register your product, visit register.fluke.com

Safety Information

Use the Imager only as specified in this manual. See Table 1 for a list of symbols used on the Imager and in this manual.

A  **Warning** identifies hazardous conditions and actions that could cause bodily harm or death.

A  **Caution** identifies conditions and actions that could damage the Imager or cause permanent loss of data.

Warning





-  **To avoid eye damage, do not point laser directly at eye or indirectly off reflective surfaces.**
- **Use of controls or adjustments or performance or procedures other than those specified herein may result in hazardous laser radiation exposure.**
- **To avoid a burn hazard, remember that highly reflective objects will result in lower than actual temperature measurements. See Emissivity information later in this manual for more information.**
- **Do not use in a manner not specified in this manual or the protection provided by the equipment may be impaired.**

Table 1-1. Symbols

	Warning. Laser.	CE	Conforms to requirements of European Union and European Free Trade Association
	Do not mix with solid waste stream. Dispose using a qualified recycler or hazardous material handler.		Important information: see manual

Laser Warning Labels

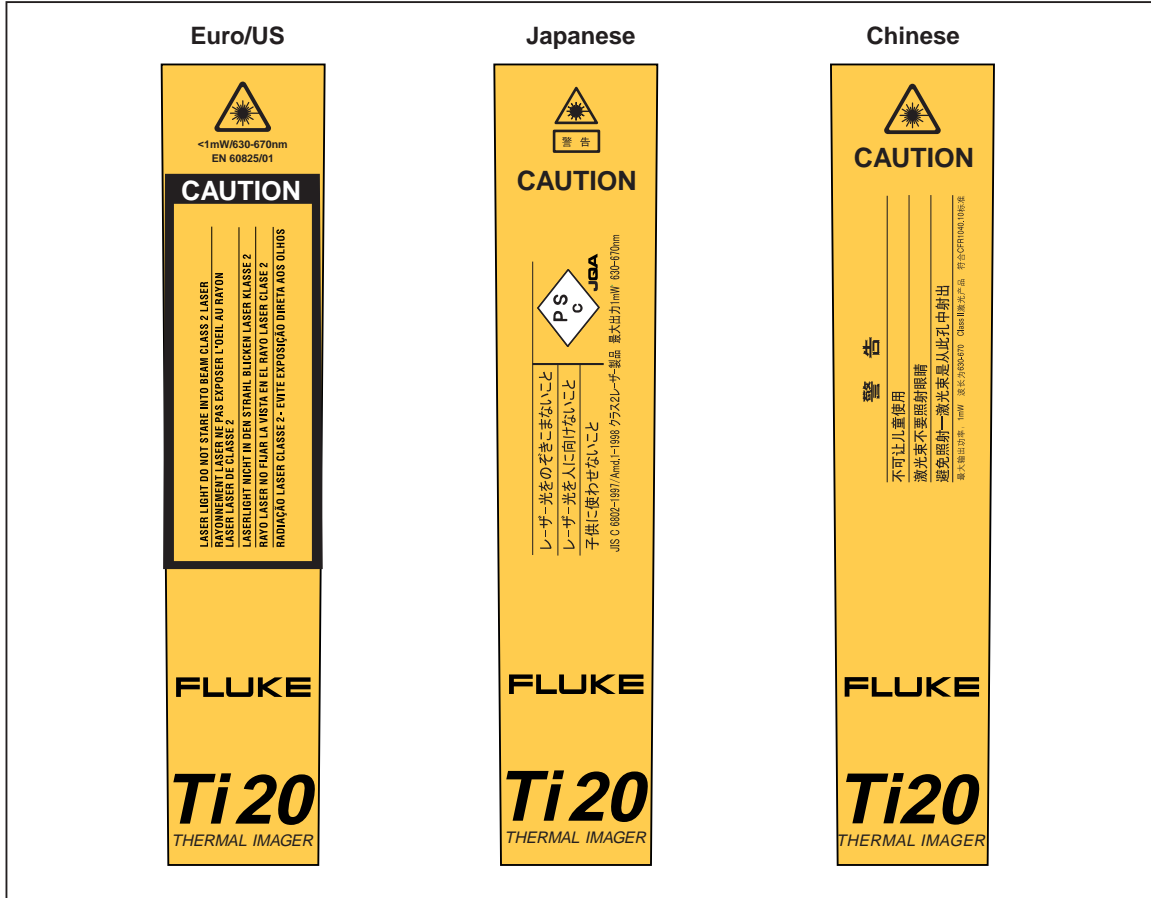

Figure 1-1. Laser Warning Labels

dag133f.eps

Unpacking the Imager

Begin by opening the shipping box. Be sure to save the box and shipping materials in case you need to ship the Imager. Inside the shipping box, you will find a hard carrying case containing the standard accessories shown in Figure 1-2 and described in Table 1-2.



Figure 1-2. Standard Accessories

dag134f.eps

Table 1-2. Standard Accessories

①	PN 1671807 USB Cable	②	PN 2444076 International AC Adapter
③	PN 2507729 External Charger for Rechargeable Battery Pack	④	PN 2518704 Hard Case
⑤	PN 2455818 Soft Case with Shoulder Strap	⑥	PN 2443380 Wrist Strap
⑦	PN 2446641 Rechargeable Battery Pack (2)	⑧	PN 2455807 AA Battery Tray
⑨	PN 2492146 CD-ROM with InsideIR software and Users Manual and PN 2492154 Ti20 Training Material	⑩	PN 2492168 Getting Started Guide
⑪	PN 2492228 Quick Reference Guide		

Features and Controls

Imager features and controls are shown in Figure 1-3 and described in Table 1-3.

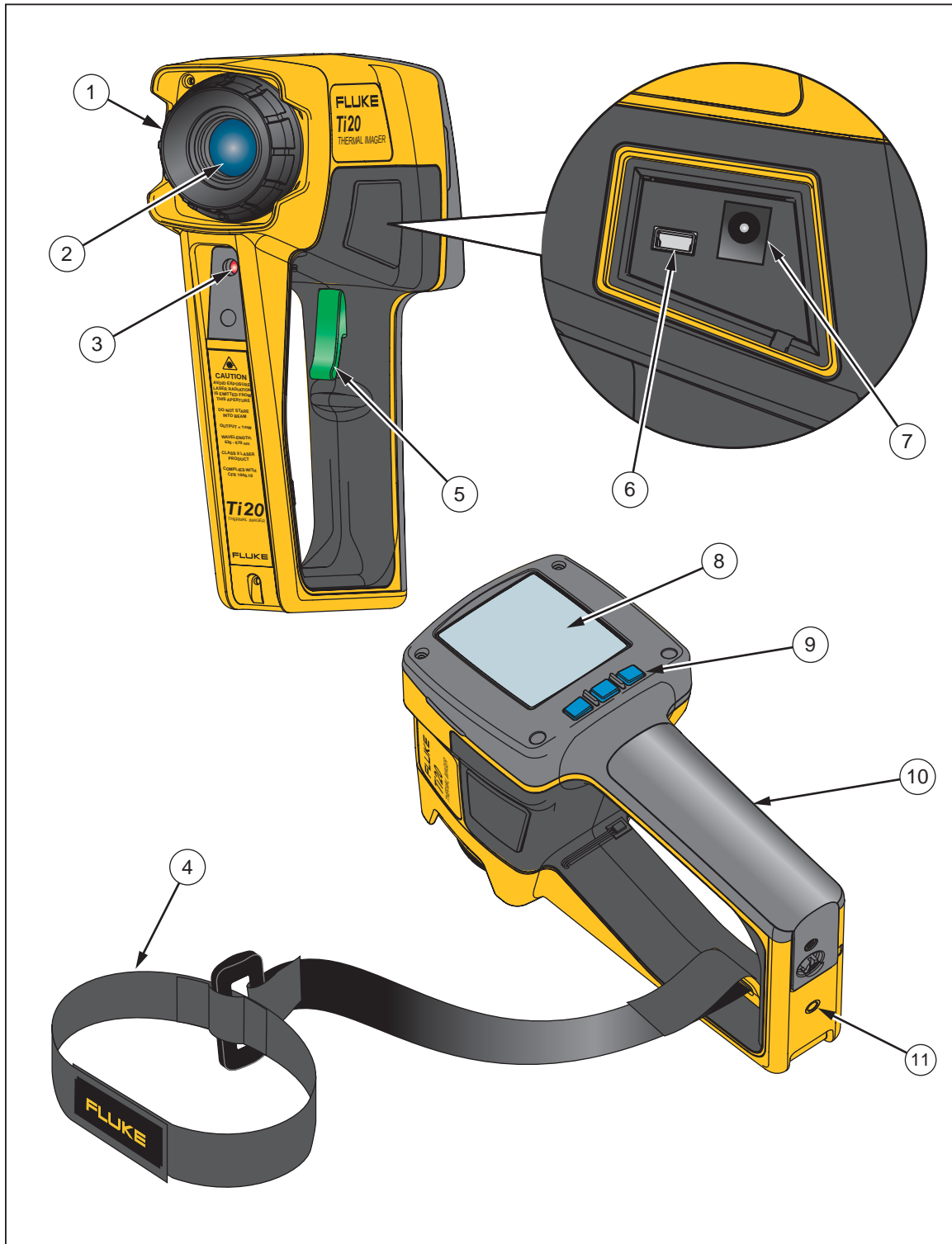







Figure 1-3. Ti20 Thermal Imager Features and Controls

dag01f.eps

Table 1-3. Features and Controls

Number	Description
①	Focus control
②	Optical channel
③	Laser aperture
④	Wrist strap and attachment clip
⑤	Trigger. The trigger is used to freeze a thermal image. Press the trigger one time to freeze the image for evaluation. You can save the image or press and release the trigger again to delete the image.
⑥	USB port
⑦	AC adapter terminal
⑧	Display
⑨	The three soft keys ( ,  , and ) are used to navigate the menu structure of the Imager, access all functions, and select values for the various adjustable parameters. The  soft key is also used to turn the Imager On and Off. Press and hold  for two seconds to turn off the Imager.
⑩	Battery compartment
⑪	Threaded tripod mount

Operating the Controls

The following sections describe the purpose and function of the two Imager controls, focus and trigger.

Focusing the Imager

Proper focus is critically important in radiometric imaging applications. The correct focus ensures that the infrared energy is being properly directed onto the pixels of the detector. Without the correct focus, the thermal image appears blurry and the radiometric data will be inaccurate. Correct focus is necessary to accurately capture a thermal image.

Focus the Imager by turning the focus control in a clockwise or counterclockwise direction (similar to the operation of a single lens reflex 35 mm photographic camera). The Imager is designed to focus at a minimum distance of 61 cm (24 in) or less (rotated fully clockwise as viewed from the rear of the instrument) and to a maximum of infinity (rotated fully counterclockwise).

As you turn the focus control, you will see a changing, live, thermal image on the display. When your target comes into focus, it will appear sharper. When the target moves out of focus, it becomes blurry. One way to verify proper focus is to find what focus adjustment produces the highest temperature indication on the display (keeping emissivity and Reflected Temperature Compensation (RTC) values constant, preferably with emissivity set at 1.0 and RTC disabled). See Figure 1-4 for an illustration of focusing the Imager.

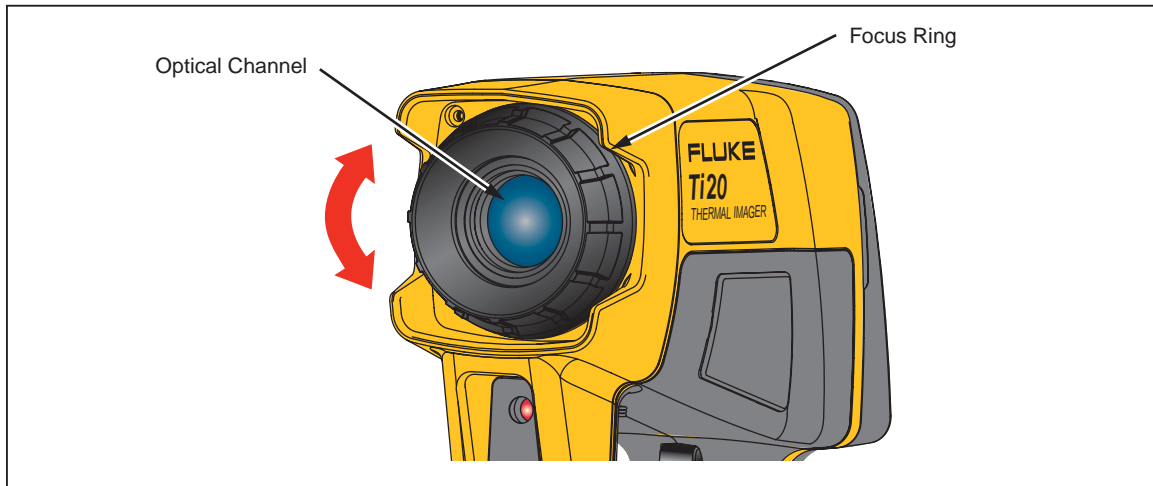

Figure 1-4. Focusing the Imager

dag02f.eps

Understanding the Trigger

The trigger is located in the standard trigger position for a pistol-grip device. The primary function of the trigger is to freeze a thermal image for possible storage to memory by the user. The trigger freezes an image in the following modes:

- In automatic temperature level and span adjustment mode
- In manual temperature level and span adjustment mode
- When scrolling through the menu levels (without entering a menu selection)

Using the AC Power Adapter

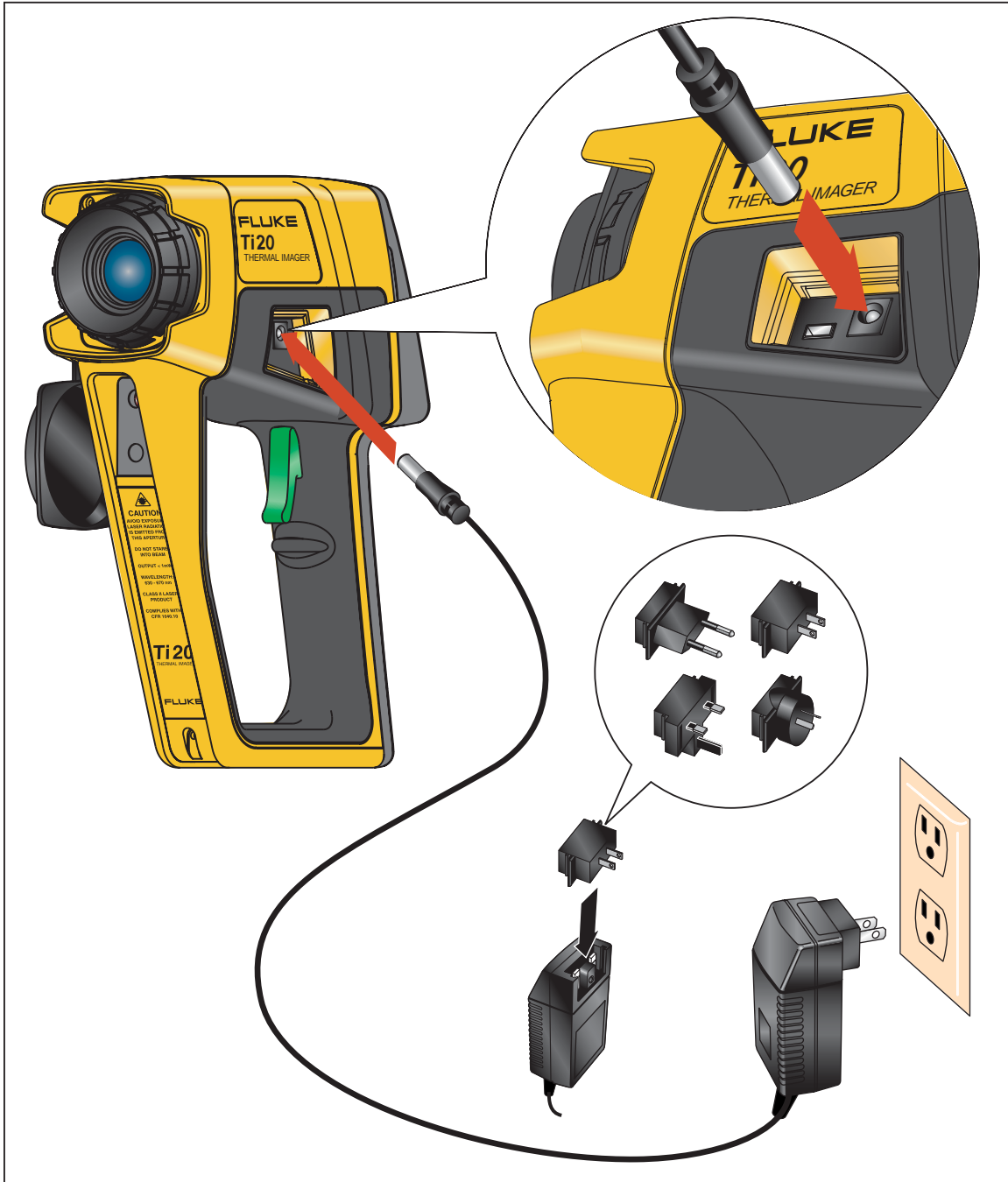

Figure 1-5. Using the AC Power Adapter

dag007f.eps

Charging and Replacing the Batteries

With the Ti20, you have the option of using six AA batteries or a rechargeable NiMH pack. The use of both options is described in the following pages. Battery charger use is shown in Figure 1-6 and battery placement in Figure 1-7 .

Using the Battery Charger

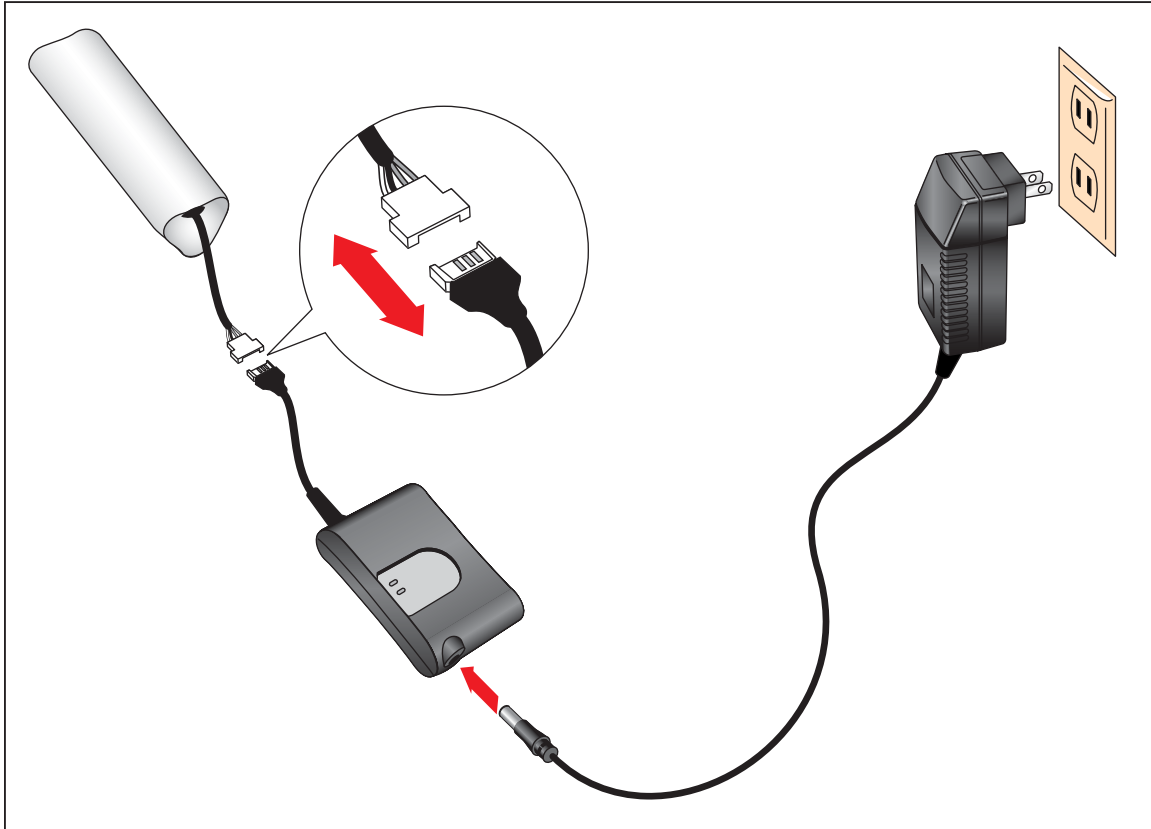

Figure 1-6. Using the Battery Charger

dag008f.eps

Installing or Replacing the Batteries

Replace the batteries with six AA batteries (NEDA 15A or IEC LR6). Install or Replace the AA battery cartridge as described below and shown in Figure 1-7.

1. Unlock the battery compartment by using a standard screwdriver to turn the battery door screw one-quarter turn counterclockwise.
2. Slide the battery compartment door off the grip.
3. Uncouple the battery connector and remove the rechargeable battery (or battery pack).
4. Change the rechargeable battery (or battery pack with fresh batteries).
5. Replace and reconnect the rechargeable battery (or battery pack).
6. Replace the battery door. Secure the door by turning the screw one-quarter turn clockwise.

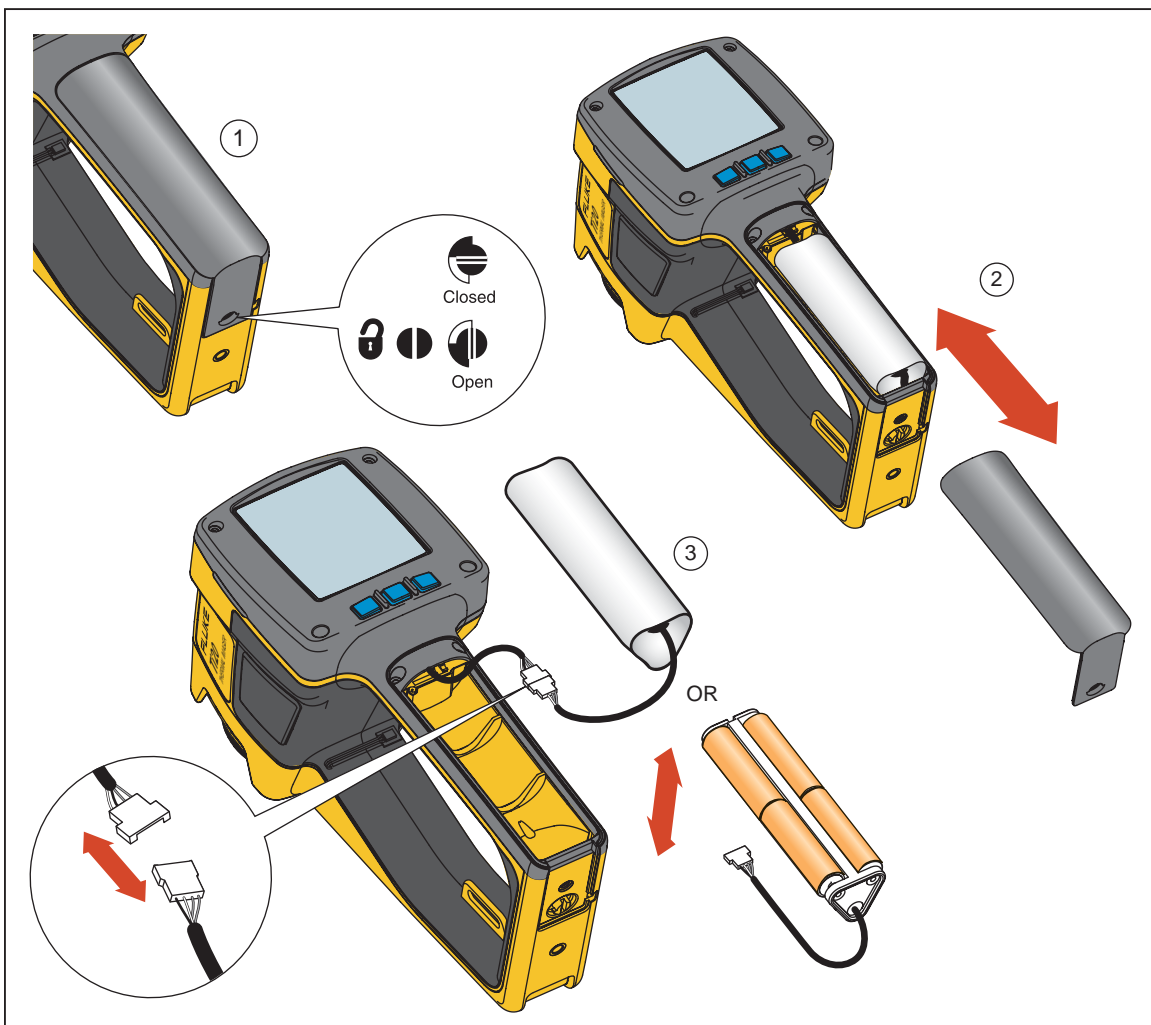

Figure 1-7. Replacing the Battery Pack

dag03f.eps

Attaching the Wrist Strap

A wrist strap is included with your Imager. You can attach the wrist strap by clipping the strap to the attachment clip on the Imager housing.

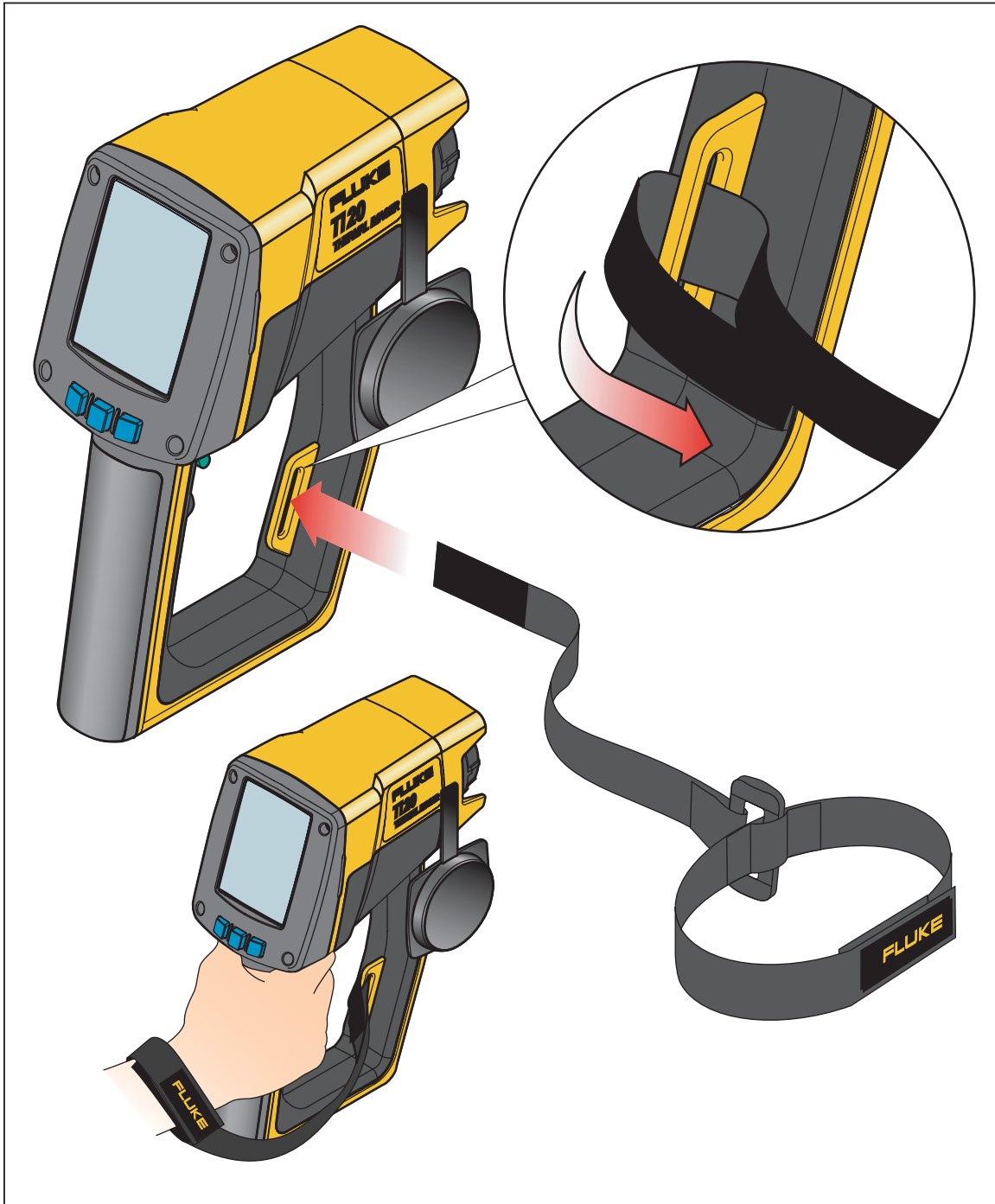

Figure 1-8. Attaching the Wrist Strap

dag131f.eps

Inputs and Connections

Connecting the USB Cable

The included USB cable can be used to either download or upload data from a PC to the Imager. To connect the USB cable, insert the smaller USB connector into the Imager port and the larger connector into the PC USB port as shown in Figure 1-9. Communications begin automatically, and a USB symbol () appears in the header area of the Imager display when communications are established.



Figure 1-9. Connecting Using the USB Cable

dag009f.eps

Mounting the Imager on a Tripod

A tripod mount is provided on the bottom side of the Imager. Rotate or screw the Imager onto a tripod using the tripod mount as shown in Figure 1-10.



Figure 1-10. Mounting the Imager on a Tripod

dag010f.eps

Cleaning

This section describes how to clean the Imager case and lens.

Cleaning the Case

Periodically wipe the case with a damp cloth and mild detergent. Do not use abrasives or solvents.

Cleaning the Lens

Although the lens is coated with a durable, erosion resistant coating (according to MIL standards), cleaning dust, sand, and other particles might scratch the coating and impair the performance of the lens.

⚠ Caution

To avoid damage, do not use tools or sharp objects when cleaning the lens.

- In a clean room, use compressed nitrogen to blow off dust and other particles.
- In a field environment, use a wet cloth to remove sand, salt, and other contaminants, do not apply pressure.
- Wipe the lens using a soft tissue paper or lens tissue.

You can also use solvents to remove grease and other contaminants:

- Acetone - use to remove grease
- Ethanol - use to remove fingerprints and other contaminants
- Alcohol - use for final cleaning before use



To clean the lens with a solvent:

1. Wet a tissue paper with acetone, ethanol, or alcohol.
2. Carefully, wipe the lens in an “S” motion so that each area of the lens will not be wiped more than once.
3. Repeat step 2 until the lens is clean. Use a new tissue each time.

Chapter 2

Basic Operation

Turning the Imager On and Off

Use the  key to turn the Imager on and off. To turn on the Imager, press and hold the  for approximately 2 seconds until the date and time appear in the upper right-hand corner of the display. The Imager splash screen appears until the Imager can reliably show an accurate thermal image. After approximately 5 seconds, the Imager loads the Home display.

The Imager splash screen is shown in Figure 2-1 and displays the following information:

- Date and Time
- Fluke and MicroIR logos
- Model Number
- Serial Number
- Firmware Version
- Route Name (if uploaded to Imager)



Figure 2-1. Imager Splash Screen

dag102f.eps

Understanding the Home Display

The Imager returns to the Home display when you complete a menu operation, escape or cancel an operation using the  soft key, or the by pressing the trigger. Figure 2-2 illustrates the Home display zones.

The Home display is divided into three zones:

- Header Zone
The header zone displays information such as Imager status, battery charge state, power source, and connection status.
- Image Zone
The image zone displays live, frozen, and stored thermal images.
- Information Zone
The information zone displays Imager settings, status comments, and selection options.

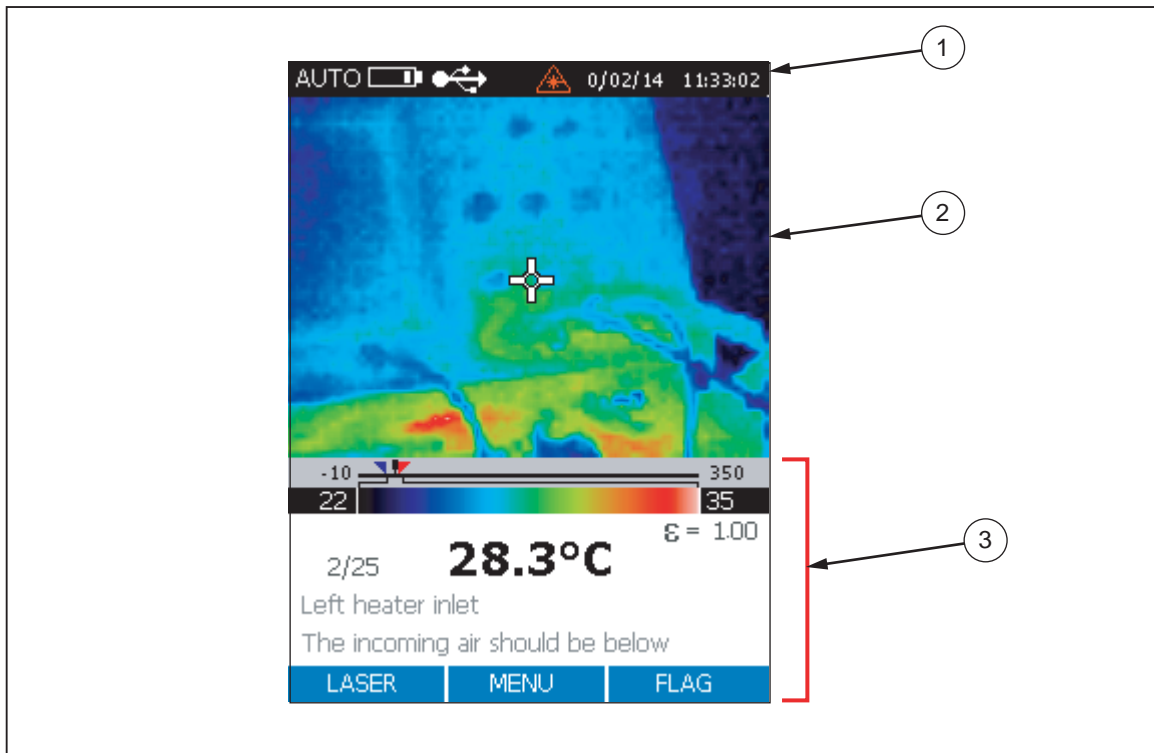

Figure 2-2. Imager Home Display Zones

dag132f.eps

The contents of the Home display is described in Table 2-1.

Table 2-1. Contents of the Home Display





Number	Zone	Displayed Information	Description
①	Header	Auto	Imager is in automatic imaging mode
		Manual	Imager is in manual imaging mode
		Calibrating	Indicates the Imager is calibrating and is temporarily incapable of measuring
		Capture	Trigger is pulled and a thermal image is frozen on the display
		Review	Imager is in review stored images mode
		Delete or Delete All	Deleting stored images
		Date and Time	Date is in DD/MM/YY format and time is in 24 hour format HH:MM.
			Battery charge state. A fully charged battery is indicated with four bars, and a discharged battery is indicated by one bar.
			Indicates the Imager is connected to an AC power source.
			The Imager has established a USB connection with the PC.
	The live video output symbol indicates that images are being copied from the Imager to the connected PC.		
②	Thermal Image		Displays live, frozen, and stored thermal images.

Table 2-1. Contents of the Home Display (cont.)



Number	Zone	Displayed Information	Description
③	Information	Temperature Scale	Displays the target temperature, lower alarm limit (blue upside triangle), high alarm limit (red upside down triangle), temperature range bar, and temperature color bar.
		Emissivity Setting	Display setting preceded by a 1 or 0 and followed by two places after the decimal point.
		RTC Setting	Reflected temperature compensation setting if RTC is turned on. No decimal places.
		Memory Location	Displays current memory location and total memory locations available. For example, if the display shows "Memory 16/32" this indicates that you are at memory location 16 and there are 32 memory locations with stored images.
		Memory Location Description	The default description is the number of the current memory location. You can create a text description using InsideIR and upload that location description and image into the Imager. Memory location description is limited to 30 characters.
		Notes	Notes about the memory location created using InsideIR. There is no limit to the number of characters you can enter with the software but the Imager will only display the first 30 characters.
		Status Comments or Selection Options	This varies by screen and operation, Examples include: <ul style="list-style-type: none"> • Overwrite memory location 25? • Delete image? • Delete ALL images? • ON or OFF for backlight adjustment • °C or °F for temperature scale

Aiming and Activating the Laser

The laser is a sighting aid and is not required to take measurements. The laser is not coaxial with the infrared channel, and the laser dot is offset from the center of the thermal image (the crosshatch at the center of the display). The laser dot is not visible in the thermal image.

Warning

 To avoid eye damage, do not point laser at eye directly or indirectly off reflective surfaces.

1. Press for  2 seconds to turn on the Imager. The date appears in the upper right-hand portion of the display.
2. Press  to turn the laser on and off. The laser warning symbol () appears in the Header zone of the display when the laser is turned on.

Note

The Japanese model of the Ti20 requires you to press and hold \square^{F1} to turn on the laser and keep it on. When you release \square^{F1} , the laser turns off.

Capturing Images

Recording images is a simple process but before starting you should note the current image location number. If you have not stored any images, the location number should be set at 1 (default) and the location descriptor will be blank. Each captured image is numbered, so you may refer to images by number. The Imager can store up to 50 images.

1. With the Imager turned on, point the Imager at the target you want to record. Squeeze the trigger once to capture the image. If the captured image is not satisfactory, press and release the trigger to discard the frozen image. Use the cross hairs to align the Imager at a point on the target.

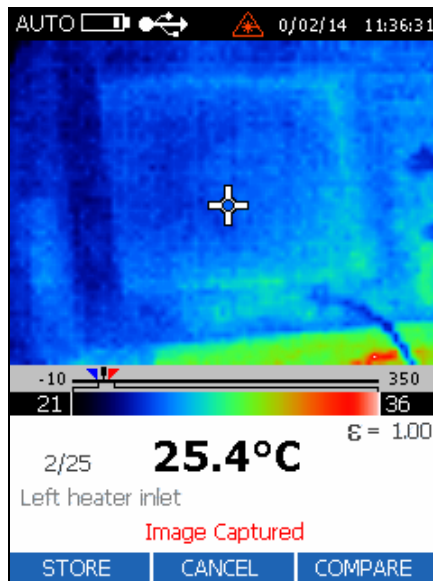

dag106f.bmp

2. The confirmation message **Image Captured** appears at the bottom of the display.
3. Inspect the image and if the result is satisfactory, press \square^{F1} (STORE) to store the image. If an image is already stored in the memory location, a prompt will ask you to confirm saving the image at that location. Press \square^{F1} (YES), \square^{F2} (CANCEL), or \square^{F3} (COMPARE). A \square^{F1} (YES) returns the Imager to live viewing.
4. Squeeze the trigger or press \square^{F1} (YES) again to return to live viewing.

Comparing Frozen Images to Stored Images

Use the Compare function to confirm that you have capture an image of the target from the correct position and to do a quick check of any thermal readings between the saved imaged and the captured image.

1. With the captured image on the display, press \square^{F3} (COMPARE) to compare the captured image to a stored image.
2. Press \square^{F1} (\triangle) to retrieve the next stored image or \square^{F2} (∇) brings up the previous stored image. Stored images appear on the right side of the display and the captured image appears on the left side of the display.

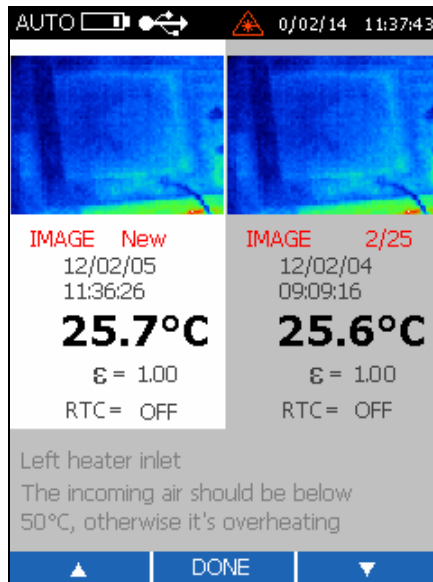

dag108f.bmp



Note

If no image is stored at the current memory location, the right side of the display is black.

3. Press  (DONE) to save the captured image. This will overwrite the current image location.



Adjusting the Backlight

Backlight ON is recommended for indoor use set the backlight OFF for outdoor applications and to save battery life. The default backlight setting is ON.

1. From the Home display, press  (MENU) five times to access the backlight function.
2. Press  (BACKLIGHT) to toggle the backlight ON and OFF.

Setting the Temperature Scale

The Imager displays temperatures using either the Celsius or Fahrenheit temperature scales. The default temperature scale is Celsius.

1. Press  (MENU) five times from the Home display to access the temperature scale function.
2. Press  (TEMPSCALE) to toggle the temperature scale between Fahrenheit and Celsius.



Setting the Level

In Manual mode, you can define Level and Span values manually. Manual mode allows you to bring both MIN and MAX values to the desired cut-off levels and to adjust the temperature interval to a minimum to maximizing color resolution. Manual mode provides the best possible image definition as to the specific inspection situation at hand, both from a thermal resolution and temperature level standpoint.

Level is the median point of a given temperature scale. For example, if the unit is currently in Automatic mode, and there is a given thermal scene with MIN and MAX temperature limits, the moment you switch the unit to Manual mode, the Level value is set by the Imager according to the following formula:

$$\text{Level} = \frac{\text{Max Span} + \text{Min Span}}{2}$$

dag129f.eps

1. Press  (MENU) one time from the Home display to access the set Mode menu.
2. Press  (MANUAL) to manually set Level and Span mode or  (AUTO) to have the Imager automatically set Level and Span.

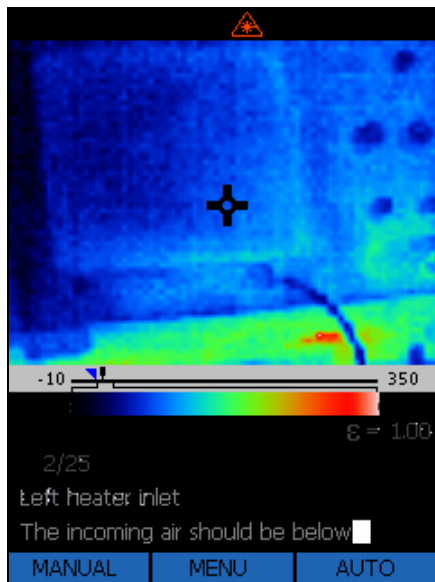

dag109f.bmp

3. Press **F1** (LEVEL) to access the set Level function.

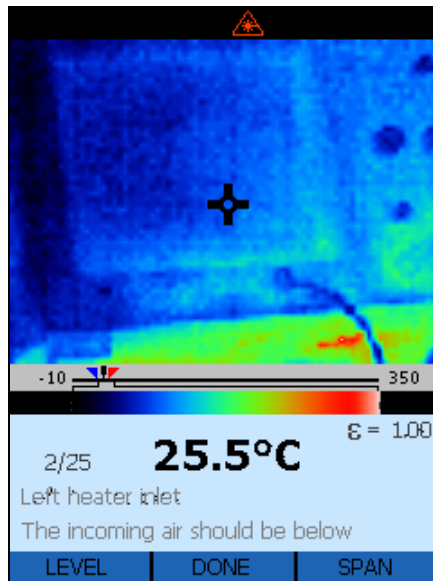

dag110f.bmp

4. Press **F1** (**◀**) to move the window to the left (lower) or **F3** (**▶**) to move the window to the right (higher).
5. Press **F2** (**⊙**) two times to return to the Home display.

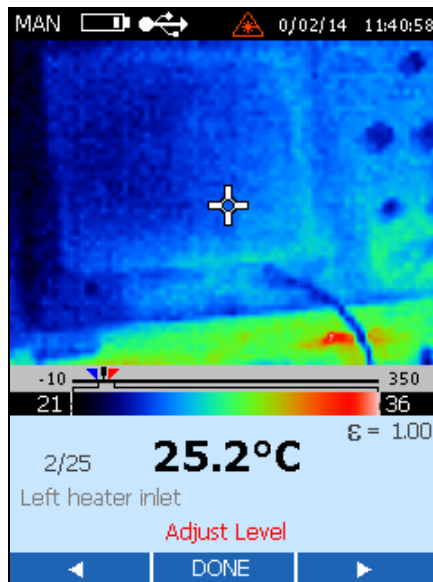











dag111f.bmp

Adjusting the Span

The full temperature span of the Imager is -10 °C to 350 °C (14 °F to 662 °F). The LCD display shows about 256 shades of color for whatever pallet you select. Adjusting the temperature span allows you to see more subtle temperature gradients in a captured image.

For example, if you are viewing an image with a temperature span from 10 °C to 30 °C and are using the Imager at full temperature span, the image will be concentrated into only about 15 of the 256 shades that could be shown. Reducing the temperature span to 10 °C to 30 °C allows you to view the display with the full range of about 256 shades.

1. Press  (HOME) one time from the Home display to access the set Mode menu.
2. Press  (MANUAL) to manually set Level and Scan mode or  (AUTO) to have the Imager automatically set Level and Scan.
3. Press  (SPAN) to access the set Span function.
4. Press  ( ) to close the range window or  ( ) to open the range window. The minimum temperature span setting is 5 °C.

Manually Activating the Calibration Flag

When the Imager is first turned on, the image freezes briefly from time to time and an hourglass icon appears briefly on the display. This is a normal process that happens when the unit momentarily shuts down the optical channel to eliminate offset errors. This is a recalibration sequence that begins immediately after the unit is turned on.

Recalibration intervals occurs at 15, 30, 45, and 60 seconds and continues every 60 seconds unless a change in ambient temperature occurs. A change in the internal temperature of 0.2 °C (0.4 °F) forces the Imager to recalibrate before the 60 seconds are up and the new calibration cycle starts at that time.

To manually activate the calibration flag, press  (FLAG) from the Main or Home menu to start the recalibration sequence.

Using Distance to Spot Size Ratio (D:S)

The Ti20 imager views a portion of the scene that is 15 ° high by 20 ° wide (the Field-Of-View (FOV), of the Imager) as shown in Figure 2-3. This scene is displayed on the LCD on the back of the Imager. The single temperature displayed numerically at the lower edge of the display, however, corresponds to a measurement of a much smaller part of the scene. In particular, it corresponds to the average temperatures of the area seen through the “hole” in the center of the reticle on the LCD display (see Figure 2-3).

The actual diameter of the measurement spot at the object is calculated by dividing the distance to the object by 75 (the D:S for the Imager). If the Imager is properly focused on a target 100 inches away, the diameter of the measurement spot on the object will be $(100 \text{ inches}) \div 75 = 1.33 \text{ inches}$. If the Imager is focused on a target 24 inches away, the diameter of the measurement spot on the object will be $(24 \text{ inches}) \div 75 = 0.32 \text{ inches}$.

To achieve the smallest measurement spot (D:S = 75:1), the imager must be properly focused on the object being measured.

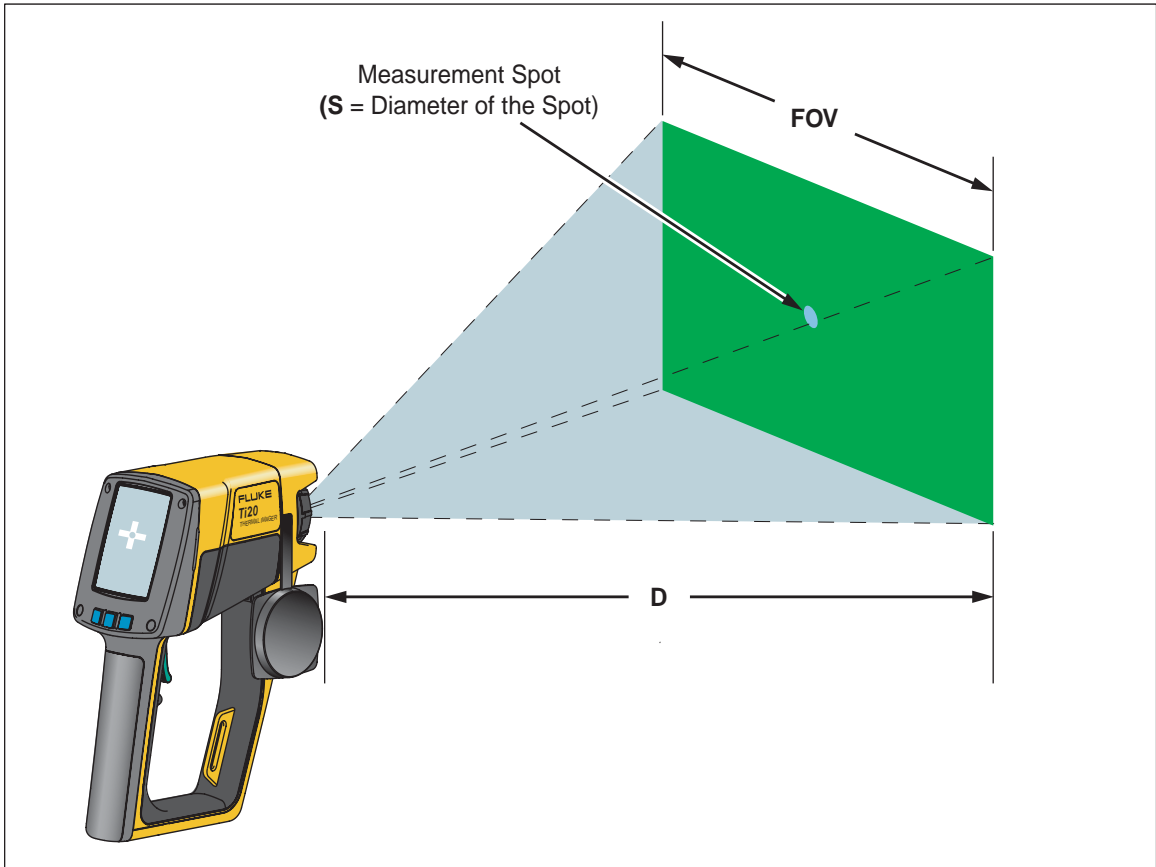

dag135f.eps

Figure 2-3. Relationship Between FOV and Measurement Spot and Reticle

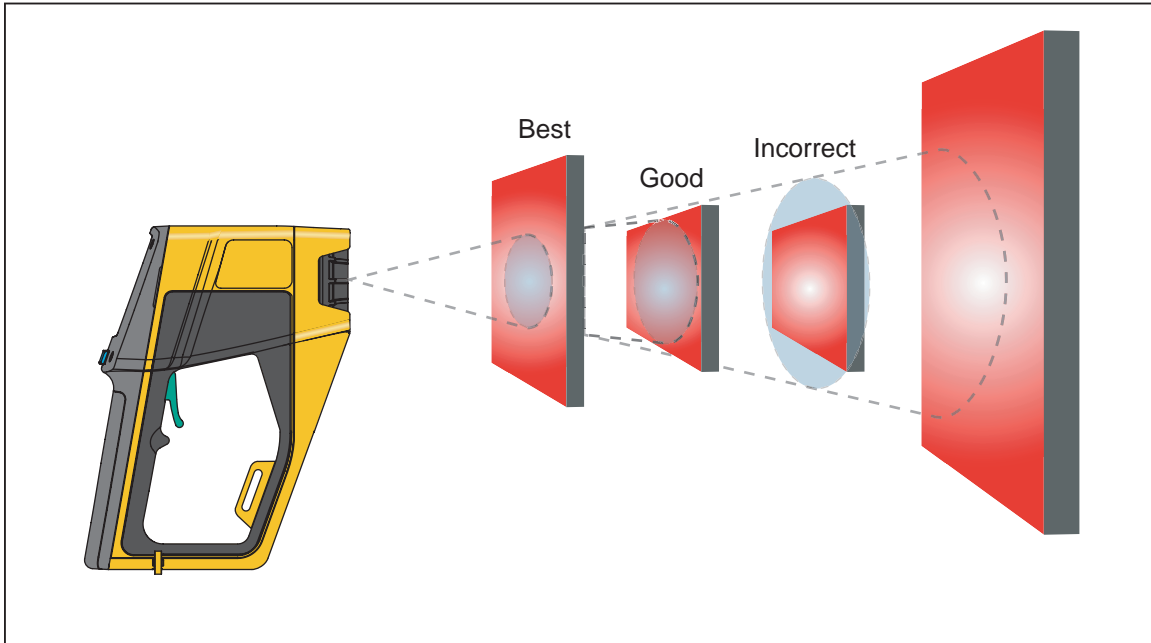

Figure 2-4. Correct Field of View

dag005f.eps

Environmental Conditions

Watch for environmental conditions in the working area. steam, dust, smoke, etc., can prevent accurate measurement by obstructing the path between the target and the Imager optics. Noise, electromagnetic fields, or vibration are other conditions that can interfere with temperature measurements, and should be considered before starting temperature measurements.

Ambient Temperature Derating and Thermal Shock

The Imager's operating temperature range is 0 °C to 50 °C (32 °F to 122 °F). As ambient temperature slowly deviates from 25 °C (77 °F) there is a derating or the Imager's accuracy specification by ± 0.2 °C/°C or $\pm 0.2\%$ / °C whichever is greater. For example, if the Imager was operating in an ambient temperature of 35 °C, the accuracy specification would be $\pm [2 + (35 - 25) \times 0.2] = \pm 4$ °C for temperatures less than 100 °C or $\pm [0.02 + (35 - 25) \times 0.002] \times T$ (temperature being measured) for temperatures greater than 100 °C.

The Imager will work accurately even when subjected to sudden ambient temperature change as large as ± 25 °C (± 45 °F) or more (going from a room at 25 °C to a freezer room at 0 °C). For the most accurate readings, you should:

- Wait ~ 2 minutes after a large ambient shock (greater than 10 °C) before making any readings.
- Turn the Imager on and then wait 3 seconds.
- For smaller ambient shocks (10 °C change or less) no special precautions are necessary.

Emissivity

Emissivity is the measure of an object's ability to emit infrared energy. The hotter an object, the more infrared energy it will emit. Emissivity can have a value from 0 (shiny mirror, perfect reflector) to 1.0 (blackbody, perfect emitter). Most organic, painted, or oxidized surfaces have emissivity values close to 0.95. If you are performing qualitative inspections with your imager, leave the emissivity set at 1.0. If you need to measure actual temperature values, set the emissivity value according to the emissivity of the material the object you are measuring is made of. Again, if you need accuracy, you will need to find the emissivity value of the material before taking the measurement. See Appendix C for the emissivity values for the most common materials.

There are two methods that help you to find the emissivity value of materials:

- **Tape method**
The tape method requires the usage of the Scotch brand PVC tape (emissivity value 0.97) or equivalent. Cover the surface you want to measure with tape. Wait some seconds for the temperature to stabilize. Set the emissivity of the Imager at 0.97 and measure the temperature. Make a note of the temperature value. Then, remove the tape and measure the new temperature value. Adjust the emissivity accordingly until the temperature value found previously is displayed on the Imager. This emissivity value is the one of the material being measured. This method is good for objects that are at low temperatures (under 100 °C (212 °F)), not electrically energized, and not in motion.
- **Contact thermometer method**
The contact thermometer method uses a contact probe and good quality temperature meter. Initially, use the contact probe temperature meter to measure the temperature of the object you want to know the emissivity value, allowing time for the contact probe to stabilize (this may take up to a minute). Note the temperature value and adjust the emissivity on the Imager accordingly until the temperature value found previously with contact probe temperature meter is displayed on the imager display. This emissivity value is the one of the material being measured. This method is good for objects that are at moderately high temperatures (under 250 °C (482 °F)), not electrically energized and not in motion.

Reflected Temperature Compensation

Targets that have low emissivities will reflect energy from nearby objects. This additional reflected energy is added to target's own emitted energy and may result in inaccurate readings. In some situations objects near the target (machines, furnaces, or other heat sources) have a temperature much higher than that of the target. In these situations it is necessary to compensate for the reflected energy from those objects. The concept of reflected temperature compensation is illustrated in Figure 2-5.

Note

The Reflected Temperature Compensation (RTC) feature is disabled when the emissivity is set to 1.00.

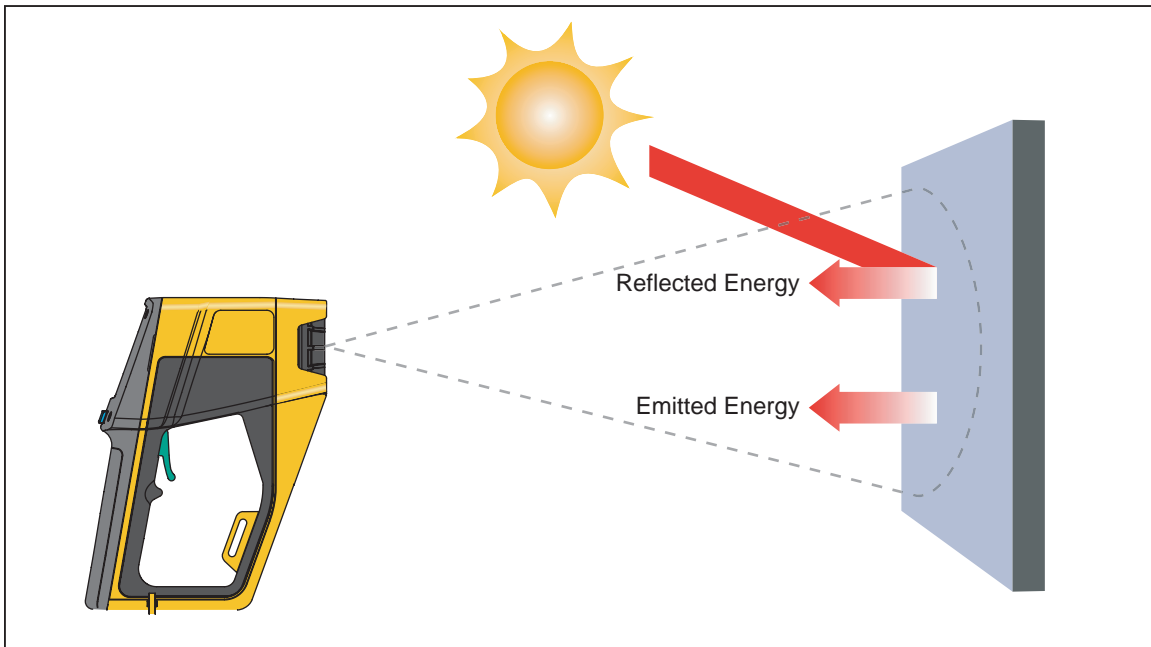

dag006f.eps



Figure 2-5. Reflected Temperature Compensation

Chapter 3

Advanced Imager Operation



Data Management and Storage

Viewing Stored Images

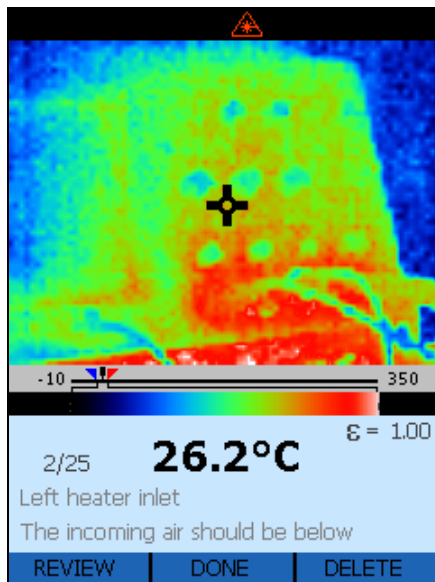
1. From the Home display, press  (MENU) two times.
2. Press  (REVIEW) for Review mode.



dag114f.bmp

3. Press  (△) to view the next image or F3 (▽) to view the previous image.
4. Press  (DONE) to return to the Home display.

Deleting Images

Deleting an image deletes the image in the active memory location but retains location description, any notes, emissivity, and RTC setting.

⚠ Caution

The delete all selection completely erases the Imager flash memory including all images, notes, emissivity values, and RTC settings. Flash memory returns to the factory default state.

1. From the Home display, press **[F2]** (MENU) two times.
2. Press **[F1]** (MEMORY) to access the Delete function.

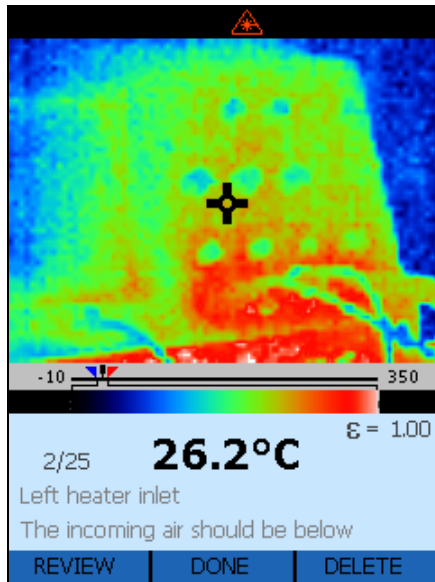

dag114f.bmp

3. Press **[F3]** for the Delete mode display.
4. Press **[F1]** (YES) to delete the image you are viewing or **[F3]** (DELETE ALL) to delete all stored images. **[F1]** deletes the displayed images but retains the memory location and information (location description, notes, emissivity, and RTC). You can also press **[F2]** (CANCEL) to return to the Review mode display.

- The Delete ALL Images display show you a representation of the stored images. Press **F1** (YES) to delete all the stored images or **F2** (CANCEL) to return to the Home display.

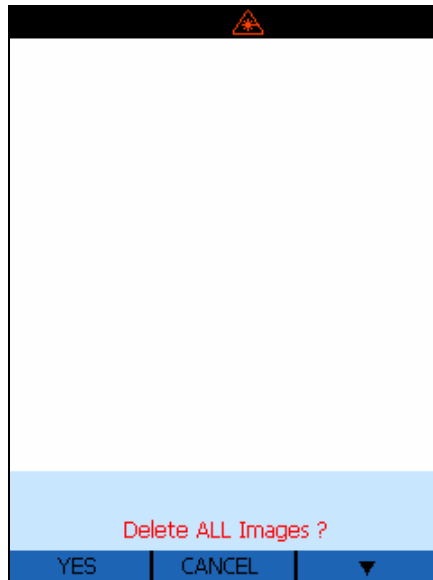



dag117f.bmp

- After deleting all images you will return to the Home display.

Selecting a Palette

Palettes are used to change the color of live thermal images or the palette of the temperature color bar. Palette options are:

- Gray
 - Rainbow (default palette)
 - Ironbow
 - Reverse Grayscale
- From the Home display, press **F2** (MENU) two times to navigate to the Palette Selection display.
 - Press **F3** (PALETTE) to choose a palette.

3. Press  (◀) to move the selection to the left or  (▶) to move the selection to the right.

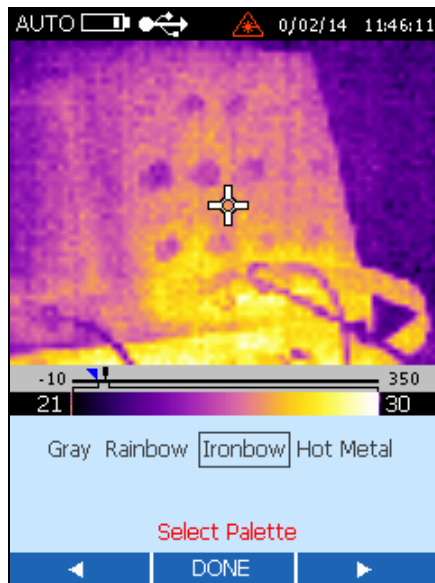

dag118f.eps

4. Press  (DONE) to make your selection and return to the Home display.

Adjusting Emissivity

The amount of infrared energy radiated by an object depends on emissivity and temperature. The emissivity depends on the material and its surface characteristics. For more accurate readings adjust the emissivity value for the type of material you are measuring. See Appendix C for typical emissivity values of various metallic and non-metallic sources.

As emissivity changes, the live thermal image will also change as the displayed temperature changes. The default emissivity setting is 0.95 and the adjustment range is from 0.01 to 1.00.

1. From the Home display, press  (MENU) three times to navigate to the Adjust Emissivity and RTC display.

- Press \square_{F1} (ϵ) to access the **Adjust Emissivity** display.

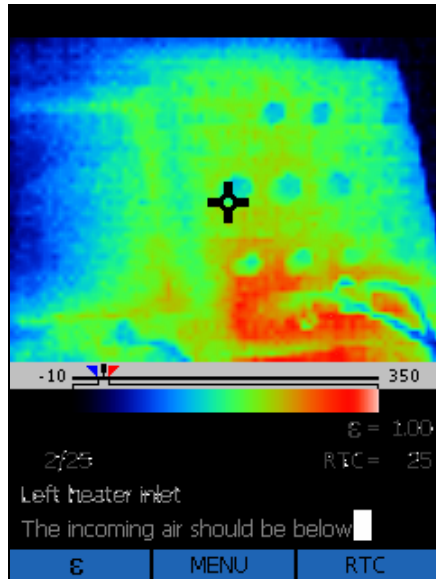

dag119f.bmp

- Press \square_{F1} (\triangle) to increase the emissivity value or \square_{F3} (∇) to decrease the emissivity value.

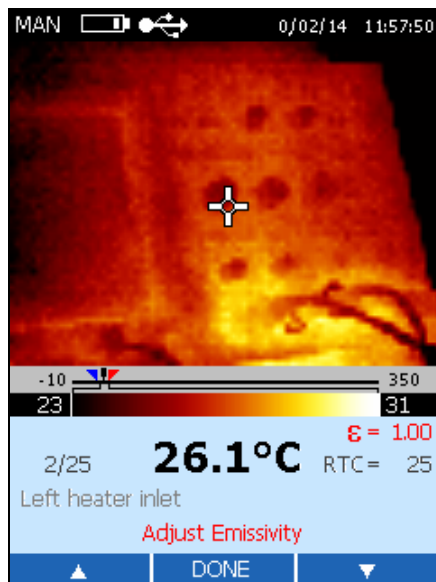





dag120f.bmp

- Press \square_{F3} (DONE) to return to the Home display.

Adjusting Reflected Temperature Compensation Values

As the RTC value changes, the live thermal image will also change as the displayed temperature changes. The default RTC setting is 100 °C (212 °F) and the adjustment range is from -50 °C to 600 °C (-58 °F to 1112 °F). RTC is OFF in the factory default state.

1. From the Home Display, press  (MENU) three times to navigate to the Adjust Emissivity and RTC display.
2. Press  (RTC) to access the Adjust RTC display.
3. Press  (RTC) to toggle RTC OFF/ON or press  (ADJUST) to access the Adjust RTC display.

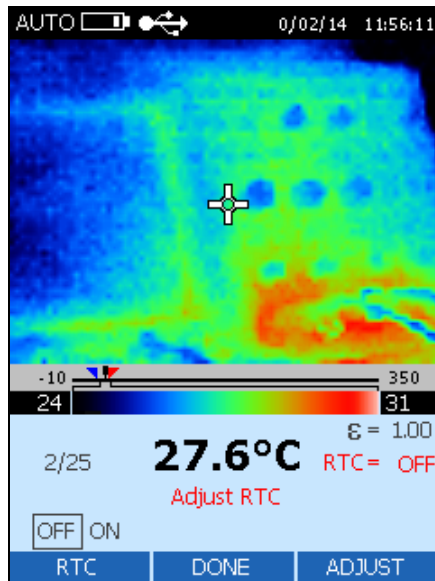

dag121f.bmp

- In the **Adjust RTC** function, Press \square_{F1} (\triangle) to increase the RTC value or \square_{F3} (∇) to decrease the RTC value.

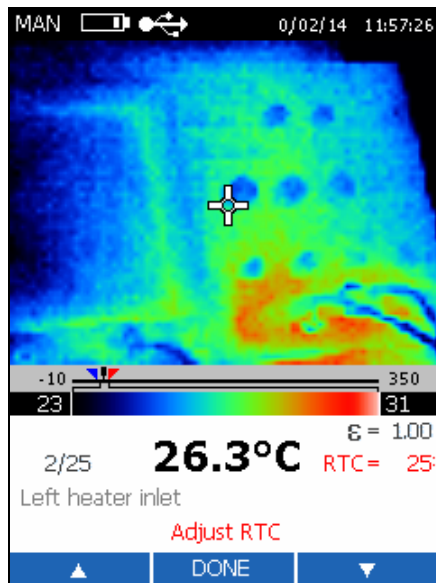

dag122f.bmp

- Press \square_{F2} (DONE) to return to the Home display.

Setting Alarm Limits

When you adjust alarm limits, the lower alarm limit appears in blue text in the information zone and upper alarm limit appears in red text in the information zone. The low alarm indicator (\blacktriangledown) and high alarm indicator (\blacktriangledown) also move on the temperature scale.

When you scan a target that registers a temperature exceeding one of the alarm limits:

- A blinking alarm indicator appears on the Imager display
- If the center pixel target temperature exceeds the alarm limit, the center image will blink and alarm value turns bold blue or bold red depending on which limit has been exceeded.

The default low alarm limit is -10 °C (14 °F) and the default high alarm limit is 350 °C (662 °F).

- From the Home display, press \square_{F2} (MENU) four times to navigate to the Adjust Alarm and Sleep Mode display.

2. Press **[F1]** (ALARM) to access the Adjust Alarms display.
3. Press **[F1]** (LOW) to adjust the low alarm limit or **[F3]** (HIGH) to adjust the high alarm limit.

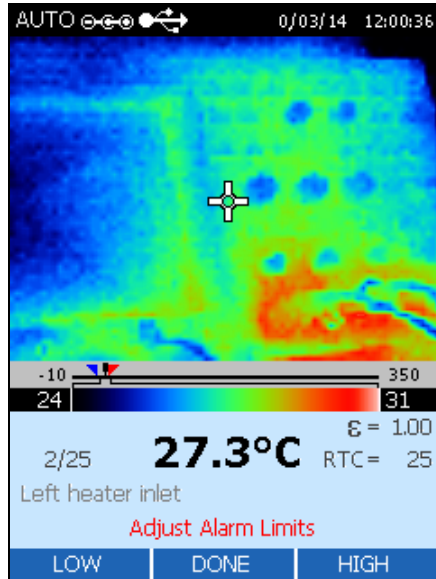

dag124f.bmp

4. Press **[F1]** (Δ) to increase the alarm limit or **[F3]** (∇) to decrease the alarm limit.

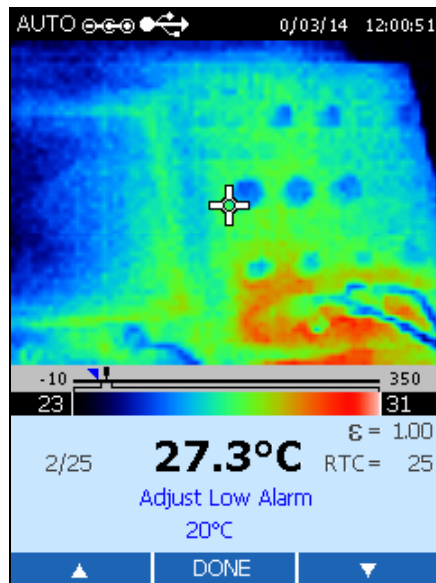

dag125f.bmp

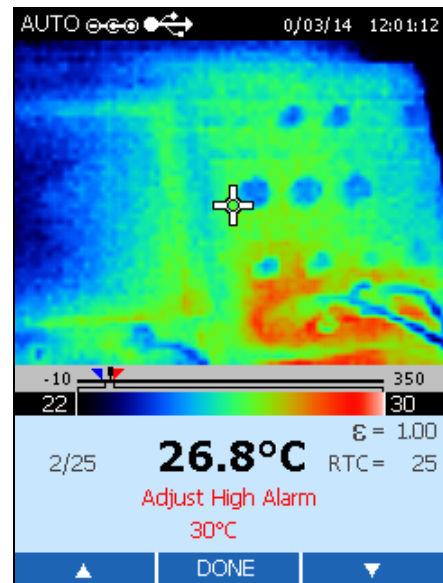





dag126f.bmp

5. Press **[F2]** (DONE) two times to return to the Home display.

Adjusting Sleep Mode

Sleep mode is used to conserve battery life if the Imager is turned on but not being used. If you turn Sleep mode **OFF**, the Imager will run until the battery is depleted. If Sleep mode is enabled, the Imager will automatically power down after the specified time period. The default Sleep mode time period is 15 minutes.

1. From the Home display, press  (MENU) four times to navigate to the Adjust Alarm and Sleep Mode display.
2. Press  (SLEEP) to access the Sleep Mode Adjust display
3. Press  (<) to move the choice box left or  (>) to move the choice box right. Options are 5, 15, 30, 60 minutes or OFF.

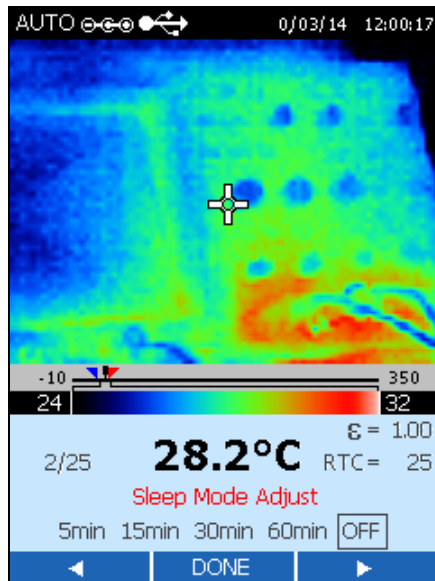

dag127f.bmp

4. Press  (DONE) to return to the Home display.

Appendices

Appendix	Contents	Page
	Glossary	A-1
	Basics of Infrared Measurement.....	B-1
	Typical Emissivity Values	C-1
	Specifications.....	D-1

Appendix A

Glossary

Absolute Zero

The temperature (0 degrees Kelvin) of an object defined by the theoretical condition where the object has zero energy.

Accuracy

Maximum deviation, expressed in temperature units, or as a percentage of the temperature reading, or as a percentage of the full scale temperature value, or as a percentage of the target temperature, indicating the difference between a temperature reading given by an instrument under ideal operating conditions, and the temperature of a calibration source (per the ASTM standard test method E 1256-88).

Ambient Derating

Refer to Temperature Coefficient.

Ambient Operating Range

Range of the ambient temperature conditions over which the thermometer is designed to operate.

Ambient Temperature

Ambient temperature is the room temperature or temperature surrounding the instrument.

Ambient Temperature Compensation (TAMB)

Refer to Reflected Temperature Compensation.

ASTM

ASTM is an abbreviation for American Society for Testing and Materials.

Atmospheric Windows

The Atmospheric Windows is the infrared spectral bands in which the atmosphere best transmits radiant energy. Two predominant windows are located at 2 to 5 μm and at 8 to 14 μm .

Background Temperature

Temperature behind and surrounding the target, as viewed from the instrument.

Blackbody

A perfect emitter; an object that absorbs all the radiant energy incident on it at all wavelengths and reflects and transmits none. A surface with emissivity of unity (1.00).

Calibration

A methodical measurement procedure to determine all the parameters significantly affecting an instrument's performance.

Calibration Source

A source (blackbody, hot plate, etc.) of known and traceable temperature and emissivity. Usually NIST traceable in the USA, with other recognized standards available for international customers.

Colored Body

See Non-Gray Body.

D:S

Distance to spot size ratio. See Optical Resolution.

Detector

A transducer which produces a voltage or current proportional to the IR energy incident upon it. See also thermopile, pyroelectric, and Si detectors.

DIN

Deutsches Institut für Normung (DIN) is the German standard for many instrumentation products.

Display Resolution

The level of precision to which a temperature value can be displayed, usually expressed in degrees or tenths of degrees.

Drift

The change in instrument indication over a long period of time, not caused by external influences on the device (per the ASTM standard test method E 1256-88).

EMC

Electro-Magnetic Compatibility is the resistance to electrical signal disturbances within IR thermometers.

Emissivity

Emissivity is the ratio of infrared energy radiated by an object at a given temperature and spectral band to the energy emitted by a perfect radiator (blackbody) at the same temperature and spectral band. The emissivity of a perfect blackbody is unity (1.00).

EMI/RFI Noise

Electro-Magnetic Interference/Radio Frequency Interference (EMI and RFI) may cause disturbances to electrical signals within IR thermometers. EMI and RFI noise is most commonly caused by devices by switching motors (air conditioners, power tools, refrigeration systems, etc.).

Far Field

A measured distance substantially greater than the focus distance of the instrument; typically greater than 10 times the focus distance.

Field of View (FOV)

The region, at the target, measured by the IR thermometer. Typically presented by giving the spot diameter as a function of distance from the instrument. Also presented as the angular size of the spot at the focus point.

See Optical Resolution.

Focus Point (or Distance)

The distance from the instrument where the optical resolution is greatest.

Full Scale

The maximum of the temperature range or output signal.

Full Scale Accuracy

A convention for expressing the accuracy as percentage of an instrument's (highest) full-scale temperature.

Gray Body

A radiating object whose emissivity is in constant ratio (not unity) at all wavelengths to that of a blackbody at the same temperature, and does not transmit infrared energy.

HAL

High Alarm. Units with this feature can sound an alarm when they sense that a user-defined high temperature has been reached.

Hertz (Hz)

Units in which frequency is expressed. Synonymous with cycles per second.

Infrared (IR)

The portion of the electromagnetic spectrum extending from the far red visible at approximately 0.75 μm , out to 1000 μm . However, because of instrument design considerations and the atmospheric windows, most infrared measurements are made between 0.75 μm and 20 μm .

Infrared Thermometer

An instrument that converts incoming IR radiation from a spot on a target surface to a measurement value that can be related to the temperature of that spot.

LAL

Low Alarm. Units with this feature can sound an alarm when they sense that a user-defined low temperature has been reached.

Laser

Single or dual lasers are used in some units for aiming and/or locating the optimum temperature measurement point.

Level

Level is the median point of a given temperature scale. For example, if the unit is currently in Automatic mode, and there is a given thermal scene with MIN and MAX temperature limits, the moment you switch the unit to Manual mode, the Level value is set by the unit according to the following formula:

$$\text{Level} = \frac{\text{Max Span} + \text{Min Span}}{2}$$

dag129f.eps

Micron (or μm)

10^{-6} meters (m), or 0.000001 m.

Minimum spot size

The smallest spot an instrument can accurately measure.

NETD

Noise Equivalent Temperature Difference. Peak to peak system electrical noise normally measured at the output (display or analog) expressed in °F or °C.

NIST Traceability

Calibration in accordance with and against standards traceable to NIST (National Institute of Standards and Technology, USA). Traceability to NIST is a means of ensuring that reference standards remain valid and their calibration remains current.

Non-Gray Body

A radiating object that is partly transparent to infrared (transmits infrared energy at certain wavelengths); also called Colored Bodies. Glass and plastic films are examples of non-gray bodies.

Optical Pyrometer

A system that, by comparing a source whose temperature is to be measured to a standardized source of illumination (usually compared to the human eye), determines the temperature of the former source.

Optical Resolution

The distance to size ratio (D:S) of the IR measurement spot, where the distance is usually defined at the focus distance, and the size is defined by the diameter of the IR energy spot at the focus (typically at the 90% IR energy spot diameter). Optical resolution may also be specified for the far field by using values of far field distance and spot size.

Pyroelectric Detector

Infrared detector that behaves as a current source with an output proportional to the rate of change of the incident IR energy.

Radiation Thermometer

A device that calculates an object's temperature (given a known emissivity) from measurement of either visible or infrared radiation from that object.

Reflectance

The ratio of the radiant energy reflected off a surface to that incident on the surface; for a gray body this is equal to unity minus emittance; for a perfect mirror this approaches unity; and for a blackbody the reflectance is zero.

Reflected Temperature Compensation

Correction feature used to achieve greater accuracy when, due to a high uniform background temperature, infrared energy is reflected off the target into the instrument. If the background temperature is known the instrument reading can be corrected by using this feature. Targets that have low emissivities will reflect energy from nearby objects, which may result in inaccurate readings. Sometimes objects near the target (machines, furnaces, or other heat sources) have a temperature much higher than that of the target. In these situations it is necessary to compensate for the reflected energy from those objects. (RTC has no effect if the emissivity is 1.0.)

Relative Humidity

The ratio, expressed as a percent, of the amount of water vapor actually present in a sample of air to the greatest amount of water vapor possible at the same temperature.

Repeatability

The degree to which a single instrument gives the same reading on the same object over successive measures under the same ambient and target conditions (per the ASTM standard test method E 1256-88).

Resolution

See Temperature Resolution or Optical Resolution.

Response Time

A measure of an instrument's change of out-put corresponding to an instantaneous change in target temperature, generally expressed in milli-seconds, for 95 percent of full scale temperature indication (per the ASTM standard test method E 1256-88). The specification for Fluke instruments also includes the average time required for software computations.

Scatter (Size of Source Effect)

An undesirable increase in temperature reading caused by IR energy outside the spot reaching the detector. The effect is most pronounced when the target is much larger than the field of view.

Span

The full temperature span of the Imager is -10 °C to 350 °C (14 °F to 662 °F). The LCD display shows about 256 shades of color for whatever pallet you select. Adjusting the temperature span allows you to see more subtle temperature gradients in a captured image.

Spectral Response

The wavelength region in which the IR Thermometer is sensitive.

Spot

The diameter of the area on the target where the temperature determination is made. The spot is defined by the circular aperture at the target that allows typically 90% of the IR energy to be collected by the instrument, as compared with the 100% spot diameter which is defined by the IR energy collected from a very large target. The actual size and distance to the target for the 100% spot diameter is specified in the calibration procedure for each instrument.

Stare

A saturation effect caused by aiming a sensor at a *hot* target for an extended period of time and then quickly aiming at a target at a *lower* temperature. The increase in time (beyond the normal system response) for the sensor to return to within 5 % of the lower temperature is defined as the *stare* time.

Storage Temperature Range

Ambient temperature range that the thermometer can safely withstand in a non-operating mode, and subsequently, operate with-in published performance specifications.

Target

The object upon which the temperature determination is being made.

Temperature

A degree of hotness or coldness of an object measurable by a specific scale; where heat is defined as thermal energy in transit, and flows from objects of higher temperature to objects of lower temperature.

Temperature Coefficient (or Ambient Derating)

An indication of the instruments ability to maintain accuracy when the ambient conditions are subject to a slow change or drift. The temperature coefficient is usually expressed as the percent change in accuracy per degree change in ambient temperature. For a rapid change in ambient conditions refer to Thermal Shock.

Temperature Resolution

The minimum simulated or actual change in target temperature that gives a usable change in output and/or indication (per the ASTM standard test method E 1256-88).

Thermal Shock

A short-term error in accuracy caused by a transient ambient temperature change. The instrument recovers from its accuracy error when it comes back into equilibrium with the new ambient conditions.

Time Constant

The time it takes for a sensing element to respond to 63.2% of a step change at the target.

Transfer Standard

A precision radiometric measurement instrument with NIST traceable calibration in the USA (with other recognized standards available for international customers) used to calibrate radiation reference sources.

Transmittance

The ratio of IR radiant energy transmitted through an object to the total IR energy received by the object for any given spectral range; the sum of emittance, reflectance, and transmittance is unity.

Appendix B

Basics of Infrared Measurement

Q. Why use non-contact infrared thermometers?

Non-contact infrared (IR) thermometers use infrared technology to quickly and conveniently measure the surface temperature of objects. They provide fast temperature readings without physically touching the object. The temperature is shown on the LCD display.

Lightweight, compact, and easy-to-use, IR thermometers and thermal imagers can safely measure hot, hazardous, or hard-to-reach surfaces without contaminating or damaging the object. Also, infrared thermometers can provide several readings per second, as compared to contact methods where each measurement can take several minutes.

Q. How does IR work?

A. IR thermometers capture the invisible infrared energy naturally emitted from all objects. Infrared radiation is part of the electromagnetic spectrum, which includes radio waves, microwaves, visible light, ultraviolet, gamma, and X-rays.

Infrared falls between the visible light of the spectrum and radio waves. Infrared wavelengths are usually expressed in microns with the infrared spectrum extending from 0.7 microns to 1000 microns. In practice, the 0.7 to 14 micron band is used for IR temperature measurement. Figure B-1 illustrates the infrared measurement region.

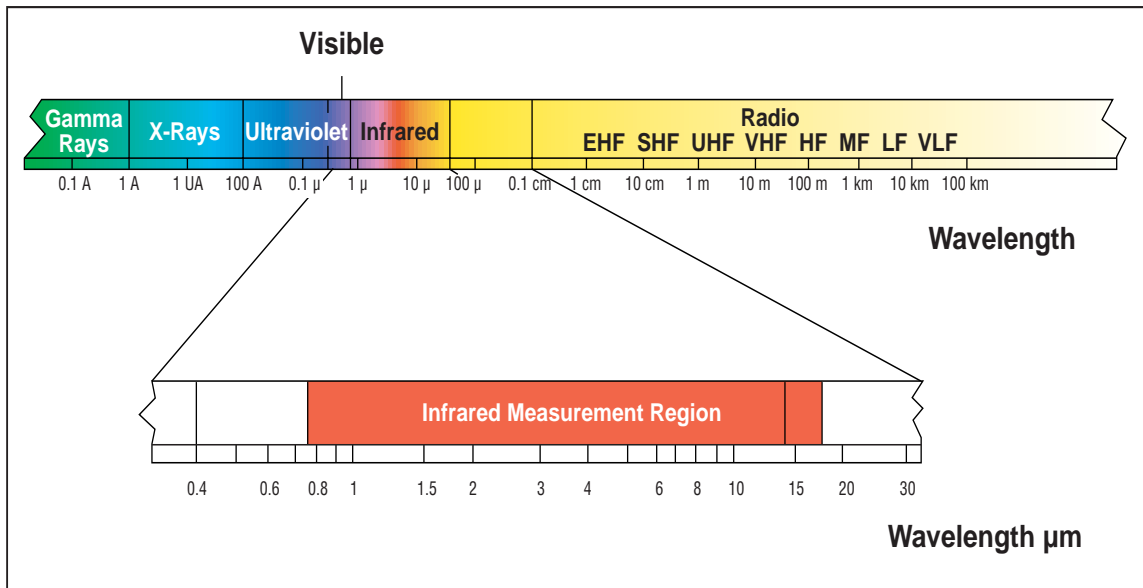

Figure B-1. Infrared Measurement Region

dag011f.eps

Q. How to assure accurate temperature measurement?

A. A solid understanding of infrared technology and its principles lies behind accurate temperature measurement. When the temperature is measured by a non-contact device the IR energy emitted from the measured object passes through the optical system of the thermometer or thermal imager and is converted to an electrical signal at the detector. This signal is then displayed as a temperature reading and/ or thermal image. There are several important factors that determine accurate measurement. The most important factors are emissivity, distance to spot ratio, and field- of-view.

Q. What is emissivity?

A. All objects reflect, transmit and emit energy. Only the emitted energy indicates the temperature of the object. When IR thermometers or thermal imagers measure the surface temperature they sense all three kinds of energy, therefore all thermometers have to be adjusted to read emitted energy only. Measuring errors are often caused by IR energy being reflected by light sources.

Some IR thermometers and thermal imagers allow you to change the emissivity in the unit. The value of emissivity for various materials can be looked up in published emissivity tables.

Other units have a fixed, pre-set emissivity of 0.95, which is the emissivity value for most organic materials and painted or oxidized surfaces. If you are using a thermometer or thermal imager with a fixed emissivity to measure the surface temperature of a shiny object you can compensate by covering the surface to be measured with masking tape or flat black paint. Allow time for the tape or paint to reach the same temperature as the material underneath. Measure the temperature of the taped or painted surface. That is the true temperature.

Q. What is the distance to spot ratio?

A. The optical system of an infrared thermometer collects the infrared energy from a circular measurement spot and focuses it on the detector. Optical resolution is defined by the ratio of the distance from instrument to the object compared to the size of the spot being measured (D:S ratio). The larger the ratio number the better the instrument's resolution, and the smaller the spot size that can be measured. The laser sighting included in some instruments only helps to aim at the measured spot.

A recent innovation in infrared optics is the addition of a Close Focus feature, which provides accurate measurement of small target areas without including unwanted background temperatures.

Make sure that the target is larger than the spot size the unit is measuring. The smaller the target, the closer you should be to it. When accuracy is critical make sure that the target is at least twice as large as the spot size.

Q. How to take temperature measurement?

A. To take a temperature measurement, just point the unit at the object you wish to measure. Be sure to consider distance-to-spot size ratio and field of view. There are important things to keep in mind while using infrared thermometers:

- Measure surface temperature only. The IR thermometer cannot measure internal temperatures.
- Do not take temperature measurement through glass. Glass has very distinctive reflection and transmission properties that do not allow accurate infrared temperature reading. Infrared thermometers are not recommended for use in measuring shiny or polished metal surfaces (stainless steel, aluminum, etc.). (See Emissivity.)
- Watch for environmental conditions. Steam, dust, smoke, etc., can prevent accurate measurement by obstructing the unit's optics.
- Watch for ambient temperatures. If the thermometer is exposed to abrupt ambient temperature differences of 10 degrees or more, allow it to adjust to the new ambient temperature for at least twenty minutes.

Q. What are some uses for non-contact thermometers?.

A. The most popular uses include:

- Predictive and Preventive Industrial Maintenance: check transformers, electrical panels, connectors, switchgear, rotating equipment, furnaces and much more.
- Automotive: Diagnose cylinder heads and heating/cooling systems.
- HVAC/R: Monitor air stratification, supply/return registers and furnace performance.
- Food Service & Safety: Scan holding, serving, and storage temperatures.
- Process Control & Monitoring: check process temperature of steel, glass, plastics, cement, paper, food & beverage

For additional information on applications for non-contact IR thermometers visit our website at www.fluke.com/thermography.

Appendix C

Typical Emissivity Values

The following tables provide references for estimating emissivity and can be used when the user does not have the means or the time to determine the emissivity value experimentally. Emissivity values shown in the tables are only approximate. Any or all of the following parameters can affect the emissivity of an object:

- Temperature
- Angle of measurement
- Geometry (plane, concave, convex, etc.)
- Thickness
- Surface quality (polished, rough, oxidized, sandblasted)
- Spectral region of measurement
- Transmissivity (i.e., thin film plastics)

Note

These following tables are to be used as a guide only, as emissivity changes with temperature, viewing angle, wavelength, target geometry and surface finish.

Table C-1. Emissivity Values for Metals

Material		Emissivity		
		1.0 μm	1.6 μm	8 to 14 μm
Aluminum				
	Unoxidized	0.1-0.2	0.02-0.2	n.r.
	Oxidized	0.4	0.4	0.2-0.4
	Alloy A3003,			
	Oxidized	n.r.	0.4	0.3
	Roughened	0.2-0.8	0.2-0.6	0.1-0.3
	Polished	0.1-0.2	0.02-0.1	n.r.
Brass				
	Polished	0.8-0.95	0.01-0.05	n.r.
	Burnished	n.r.	n.r.	0.3
	Oxidized	0.6	0.6	0.5
Chromium		0.4	0.4	n.r.
Copper				
	Polished	n.r.	0.03	n.r.
	Roughened	n.r.	0.05-0.2	n.r.
	Oxidized	0.2-0.8	.2-0.9	0.4-0.8
	Electrical Terminal Blocks	n.r.	n.r.	0.6
Gold		0.3	0.01-0.1	n.r.
Haynes Alloy		0.5-0.9	0.6-0.9	0.3-0.8
Inconel				
	Oxidized	0.4-0.9	0.6-0.9	0.7-0.95
	Sandblasted	0.3-0.4	0.3-0.6	0.3-0.6
	Electropolished	0.2-0.5	0.25	0.15
Iron				
	Oxidized	0.4-0.8	0.5-0.9	0.5-0.9
	Unoxidized	0.35	0.1-0.3	n.r.
	Rusted	n.r.	0.6-0.9	0.5-0.7
	Molten	0.35	0.4-0.6	n.r.

Table C-1. Emissivity Values for Metals (cont)

Material		Emissivity		
		1.0 μm	1.6 μm	8 to 14 μm
Iron, Cast				
	Oxidized	0.7-0.9	0.7-0.9	0.6-0.95
	Unoxidized	0.35	0.3	0.2
	Molten	0.35	0.3-0.4	0.2-0.3
Iron, Wrought				
	Dull	0.9	0.9	0.9
Lead				
	Polished	0.35	0.05-0.2	n.r.
	Rough	0.65	0.6	0.4
	Oxidized	n.r.	0.3-0.7	0.2-0.6
Magnesium		0.3-0.8	0.05-0.3	n.r.
Mercury		n.r.	0.05-0.15	n.r.
Molybdenum				
	Oxidized	0.5-0.9	0.4-0.9	0.2-0.6
	Unoxidized	0.25-0.35	0.1-0.35	0.1
Monel (Ni-Cu)		0.3	0.2-0.6	0.1-0.14
Nickel				
	Oxidized	0.8-0.9	0.4-0.7	0.2-0.5
	Electrolytic	0.2-0.4	0.1-0.3	n.r.
Platinum				
	Black	n.r.	0.95	0.9
Silver		n.r.	0.02	n.r.
Steel				
	Cold-Rolled	0.8-0.9	0.8-0.9	0.7-0.9
	Ground Sheet	n.r.	n.r.	0.4-0.6
	Polished Sheet	0.35	0.25	0.1
	Molten	0.35	0.25-0.4	n.r.
	Oxidized	0.8-0.9	0.8-0.9	0.7-0.9
	Stainless	0.35	0.2-0.9	0.1-0.8

Table C-1. Emissivity Values for Metals (cont)

Material		Emissivity		
		1.0 μm	1.6 μm	8 to 14 μm
Tin (Unoxidized)		0.25	0.1-0.3	n.r.
Titanium				
	Polished	0.5-0.75	0.3-0.5	n.r.
	Oxidized	n.r.	0.6-0.8	0.5-0.6
Tungsten		n.r.	0.1-0.6	n.r.
	Polished	0.35-0.4	0.1-0.3	n.r.
Zinc				
	Oxidized	0.6	0.15	0.1
	Polished	0.5	0.05	n.r.

Table C-2. Emissivity Values for Non-Metals

Material		Emissivity		
		1.0 μm	1.6 μm	8 to 14 μm
Asbestos		0.9	0.9	0.95
Asphalt		n.r.	0.95	0.95
Basalt		n.r.	0.7	0.7
Carbon				
	Unoxidized	0.8-0.95	0.8-0.9	0.8-0.9
	Graphite	0.8-0.9	0.7-0.9	0.7-0.8
Carborundum		n.r.	0.9	0.9
Ceramic		0.4	0.85-0.95	0.95
Clay		n.r.	0.85-0.95	0.95
Concrete		0.65	0.9	0.95
Cloth		n.r.	0.95	0.95
Glass				
	Plate	n.r.	0.98	0.85
	"Gob"	n.r.	0.9	n.r.
Gravel		n.r.	0.95	0.95
Gypsum		n.r.	0.4-0.97	0.8-0.95
Ice		n.r.	—	0.98

Table C-2. Emissivity Values for Non-Metals (cont)

Material	Emissivity		
	1.0 μm	1.6 μm	8 to 14 μm
Limestone	n.r.	0.4-0.98	
Paint (non-Al.)	—	0.9-0.95	0.9-0.95
Paper (any color)	n.r.	0.95	0.95
Plastic (opaque, over 20 mils)	n.r.	0.95	0.95
Rubber	n.r.	0.9	0.95
Sand	n.r.	0.9	0.9
Snow	n.r.	—	0.9
Soil	n.r.	—	0.9-0.98
Water	n.r.	—	0.93
Wood, Natural	n.r.	0.9-0.95	

To optimize surface temperature measurement accuracy consider the following:

- Determine the object emissivity for the spectral range of the instrument to be used for the measurement.
- Avoid reflections by shielding object from surrounding high temperature sources.
- For higher temperature objects use shorter wavelength instruments, whenever possible.
- For semi-transparent materials such as plastic film and glass, assure that the background is uniform and lower in temperature than the object.
- Hold instrument perpendicular to surface whenever emissivity is less than 0.9. In all cases, do not exceed angles more than 30 degrees from incidence.

Appendix D

Specifications

Thermal

Temperature Range.....	-10 to 350 °C (14 to 662 °F)
Detector Type	80 x 60 thermal element focal plane array (FPA)
Accuracy	± 2 °C or 2 % (whichever is greater)
Repeatability	± 1 % or ± 1 °C (± 2 °F) whichever is greater
NETD (Thermal Sensitivity)	200 mK
Temperature Indication	0.1 °C or 0.2 °F

Optical

Field of View (FOV).....	Rectangular. 20° Horizontal x 15° Vertical
Minimum Diameter.....	8.1 mm (0.32 in) at 61 cm (24 in)
Optical Resolution (D:S)	75:1 or better
Spectral Range	7.5 to 14 microns
Target Sighting.....	Single Laser (IEC 825/93 Class II, FDA LFR 1040.10 Class II)
Instantaneous Field of View.....	4.4 mrad

Controls

Focus	61 cm (24 in) to infinity
Temperature Scale	°C or °F selectable
Palettes	Original, Gray, Rainbow (default), Ironbow, Gray Reverse
Measurement Modes	Automatic or Manual
LCD Backlight.....	Bright/Dim selectable

Operational

Adjustable Emissivity10 to 1.00 by 0.01
Liquid Crystal Display	70.5 mm (2.78 in) x 53.5 mm (2.1 in)
Reflected Background Temperature.....	-50 to 905 °C (-58 to 1661 °F)
Ambient Operating Temperature	0 to 50 °C (32 to 122 °F)
Relative Humidity.....	10 to 90 % noncondensing
Storage Temperature.....	-25 to 70 °C (-13 to 158 °F) without batteries
Storage Capacity	50 images

Electrical

Power.....	Rechargeable battery pack (included)
Battery Life.....	Minimum 3 hours continuous use
Battery Charge Time.....	2 hours in the Imager, 1 hour in the external charger (or until the green LED turns on)
Data Transfer.....	USB interface, transfer time 25 sec for 50 images
Storage Device	Flash Memory

Other

Weight.....	1.2 kg (2.65 lb)
Shock.....	Half-sine, 11 ms, 30 g peak per MIL-PRF-28800F
Vibration.....	Random 6 G Sinusoidal MIL-PRF-28800, paragraph 4.5.5.3.1, Class 2
EMC.....	EN 61326-1