

FLUKE

80i-110s AC/DC Current Probe Instruction Sheet

Introducing The Current Probe

- The Fluke 80i-110s is a clamp-on AC/DC Current Probe that reproduces current waveforms found in modern commercial and industrial power distribution systems. The probe's performance is optimized for accurate reproduction of currents at line frequency and up to the 50th harmonic waveform. The 80i-110s is also compatible with any instrument capable of millivolt measurements. The Current Probe (shown in Figure 1) provides the following benefits:
- Accurate AC, DC and AC+DC current measurements for Electrical, Electronic and Automotive applications.
- Shielded for high noise immunity around electronic motor drives and ignition systems.
- Wide measurement range from 50 milliamps to 100 amps, useful to 10 milliamps.
- Jaw shaped for easy access to cramped spaces.
- Safety-designed 600 volt insulated BNC - compatible with Fluke ScopeMeter® test tools, Power Harmonic analyzers, and oscilloscopes.
- Selectable output of 10 millivolts per 1 amp for the 100 A range, and 100 millivolts per 1 amp for the 10 A range.

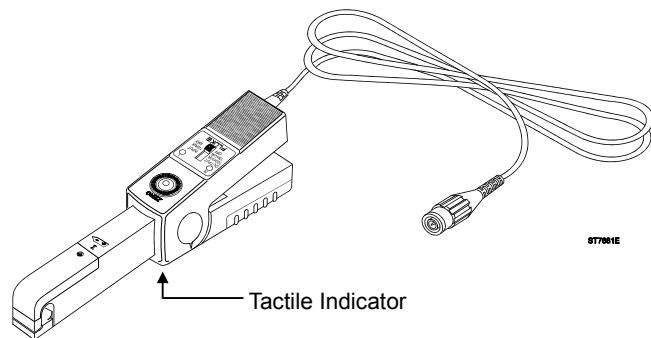

Figure 1. 80i-110s AC/DC Current Probe

Unpacking

- The following items should be included in your Current Probe box:
- AC/DC Current Probe, 80i-110s
 - Instruction Sheet (this sheet)
 - 9 volt Battery, type IEC 6LR61
- Check the contents of the shipping box for completeness. If something in the box has been damaged or missing, contact your distributor or the nearest FLUKE sales or service office immediately.

4822 872 30777
October 2005
© 2005 Fluke Corporation.
All rights reserved.
Printed in the Netherlands.
All product names are trademarks
of their respective companies.



Installing The Battery



To avoid electrical shock, unclamp the current probe from any conductor, and disconnect the scopemeter test tool or any other measurement device before installing or replacing the battery.

- At first use, remember to install the battery. Referring to Figure 2, use the following procedure to install the battery:
- Be sure that you have unclamped the Current Probe from any conductor and have disconnected the ScopeMeter test tool or any other measurement device.
 - Be sure that the Current Probe is in the OFF position.
 - Locate the battery cover on the handle. (see Figure 2.) Loosen the screw with a flat-blade screwdriver.
 - Slide the battery cover away from the Current Probe.
 - Install the battery (IEC 6LR61) as shown in Figure 2. Arrange the battery leads so that they will not be pinched between the handle bottom and the battery cover.
 - Reinstall the battery cover and secure the screw.

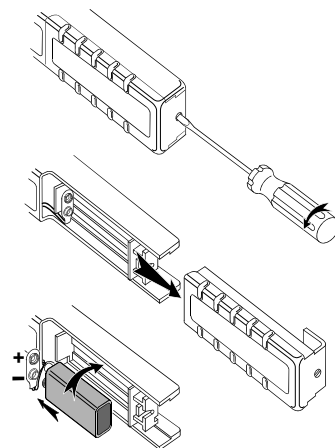

Figure 2. Installing the Battery

Safety information



Read First: Safety Information

To ensure safe operation and service of the Current Probe, follow these instructions:

- Read the operating instructions before use and follow all safety instructions.
- Use the Current Probe only as specified in the operating instructions, otherwise the current probe's safety features may not protect you.
- Adhere to local and national safety codes. Individual protective equipment must be used to prevent shock and arc blast injury where hazardous live conductors are exposed.
- Do not hold the Current Probe anywhere beyond the tactile indicator, see Figure 1.
- Before each use, inspect the Current Probe. Look for cracks or missing portions of the Current Probe housing or output cable insulation. Also look for loose or weakened components. Pay particular attention to the insulation surrounding the jaws.
- Check the magnetic mating surfaces of the Current Probe jaws; these should be free of dust, dirt, rust and other foreign matter.
- Never use the Current Probe on a circuit with voltages higher than 600 V CAT II or 300 V CAT III.
 - CAT II equipment is designed to protect against transients in circuits directly connected to the low-voltage installation, such as household appliances, portable tools and similar equipment.
 - CAT III equipment is designed to protect against transients in equipment in fixed equipment installations, such as distribution panels, feeders and short branch circuits, and lighting systems in large buildings.
- Use extreme caution when working around bare conductors or bus bars. Contact with the conductor could result in electric shock.
- Use caution when working with voltages above 60 V dc, 30 V ac rms or 42 V ac peak. Such voltages pose a shock hazard.
- Use of this equipment in a manner not specified herein may impair the protection provided by the equipment.

Symbols

| | |
|--|---|
| | May be used on HAZARDOUS LIVE conductors. |
| | Product is protected by double insulation. |
| | Risk of Danger. Important information. See Instruction Sheet. |
| | Risk of Electric Shock. |
| | Conforms to relevant European standards. |
| | Earth ground. |
| | Battery. |

Electrical Specifications

All Electrical Specifications are valid at a temperature of 23 °C ± 3 °C (73 °F ± 5 °F).

| | |
|------------------------|-------------------------|
| Current Ranges: | 0 to 10A dc or ac peak |
| | 0 to 100A dc or ac peak |
| Output Signals: | 10A range: 100 mV/A |
| | 100A range: 10 mV/A |



Working voltage (Probe jaws to Ground) & Floating Voltage (Output cable and connector to Ground):

600V ac rms on Measurement Category II (CAT II) & 300V ac rms on Measurement Category III (CAT III) circuits per EN/IEC 61010-1.

Basic Accuracy (DC to 1kHz):

| Input Current (DC or AC peak) | Error (after zero check) | |
|-------------------------------|--------------------------|------------------------|
| | 100 mV/A | 10 mV/A |
| 0 to 10A | <3% of reading +50 mA | - |
| 0 to 40A | - | <4% of reading +50 mA |
| 40 to 80A | - | <12% of reading +50 mA |
| 80 to 100A | - | <15% of reading |

Extended Accuracy:

For other frequencies, refer to the appropriate input current range and add the error listed below to the "Basic Accuracy" error.

| Frequency | Additional Error | |
|-------------|------------------|---------------|
| | 100 mV/A | 10 mV/A |
| 1 to 5 kHz | 3% | 3% |
| 5 to 20 kHz | 12% | 12% |
| >20 kHz | not specified | not specified |

Input Load Impedance (of host instrument):

>1 MΩ in parallel with up to 100 pF

Useful Bandwidth (-3 dB): 0 to 100 kHz

Rise or Fall Time: <4 μsec

Output noise level: 10 mV/A typ. 480 μV pk-pk
100 mV/A typ. 3 mV pk-pk

Max. non destructive current: 0 to 2 kHz 140A peak
2 to 10 kHz 110A peak
10 to 20 kHz 70 A peak
20 to 50 kHz 30A peak
50 to 100 kHz 20A peak

Temperature coefficient:

2000 ppm/°C max. for temperature from 0 to 50 °C (32 to 132 °F)

General Specifications

| | |
|---------------------------------------|---|
| Dimensions: | 67 x 231 x 36 mm (2.6 x 9.1 x 1.4 inches) |
| Weight: | 330g (11.6 oz.), battery included |
| Output Cable: | 1.6 meters (63 inches) |
| Maximum Conductor Size: | 11.8 mm (.46 inch) |
| Maximum Jaw Opening: | 12.5 mm (.49 inch) |
| Temperature: | operating: 0 to 50°C (32 to 122°F) nonoperating: -30 to 70°C (-22 to 158°F) |
| Relative Humidity (Operating): | 0 to 85% (0 to 35°C; 32 to 95°F) 0 to 45% (35 to 50°C; 95 to 122°F) |
| Altitude: | operating: 0 to 2000 meters (0 to 6560 feet) nonoperating: 0 to 12000 meters (0 to 40000 feet) |
| Demagnetize Probe: | Open and close probe jaws several times |

Safety Specifications

Complies with American Industry standards UL61010B-1 & UL61010B-2-032, Canadian standards CAN/CSA C22.2 No. 61010-1 (2004) & No. 61010-2-032 (2004) and European standards EN/IEC 61010-1 2nd Edition & EN/IEC 61010- 02-032.

Measurement Category Rating: 300V CAT III & 600 V CAT II, pollution degree 2.

This product is in conformity with Electromagnetic Compatibility Directive 89/336/EEC, and low Voltage Directive 73/23/EEC.

This conformity is indicated by the symbol **CE**, i.e. "Conformité européenne".

Battery Information

| | |
|--------------------------------|--|
| Battery: | 9 volt, IEC 6LR61 |
| Consumption: | 8.6 mA typical 12 mA maximum |
| Service life: | 55 hours typical, when Alkaline IEC 6LR61 is used 40 hours minimum, when Alkaline IEC 6LR61 is used |
| Battery indicator (ON): | Green LED dims when battery voltage is below 6.5V |



To avoid false readings which could cause injury, replace battery as soon as the Battery Indicator green LED dims.

Overload indicator (OL):

Red LED indicates that waveform or impulse is out of range

Instrument Compatibility

The 80i-110s is compatible with any Fluke ScopeMeter test tool, Power Harmonics Analyzer, Oscilloscope, Multimeter, or other voltage measurement device that has the following features:

- BNC input connector. A BNC-to-banana adapter (order PM9081/001 from Fluke) can also be used with standard inputs on a digital multimeter (DMM).
- Input accuracy of 2% or better to take full advantage of the accuracy of the probe.
- Input impedance of greater than or equal to 1 MΩ in parallel with a maximum of 100 pF.
- A passband of more than four times the frequency of the waveform to be measured.

Using The Current Probe

To use the Current Probe, follow these instructions:

- Connect the 80i-110s Current Probe to the desired input on the measuring instrument. When the ScopeMeter test tool or an oscilloscope is used, it must have DC coupled input. When you are using a digital multimeter, use the BNC-to-banana adapter (PM9081/001) to connect the probe to the input.
- On the Current Probe, select the least sensitive range (10 mV/A). Ensure that the green ON-indicator lights. See Figure 4 for selector switch and green On indicator locations.
- On the Current Probe, rotate the ZERO thumbwheel to adjust the probe reading to zero. See Figure 4 for the ZERO rotary knob location.
- Select the appropriate probe sensitivity on your ScopeMeter test tool or oscilloscope.
- Clamp the Current Probe around the conductor; be sure that the arrow marked on the jaw of the Current Probe points toward the correct orientation. (see Figure 3.)

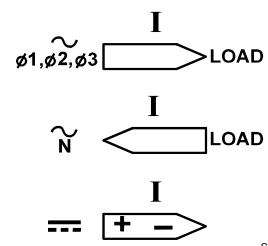

Figure 3. Orientation of the Current Probe

- Observe the current value or waveform on your display or the current value readout on the multimeter.
- On the ScopeMeter test tool, adjust the vertical range knob and time division knob for the best display.
- If the red OL-indicator lights, the Current Probe is in overload mode.
- At completion, be sure to set the range selection switch to OFF again. A measuring setup using the Current Probe and a ScopeMeter test tool is shown in Figure 4.

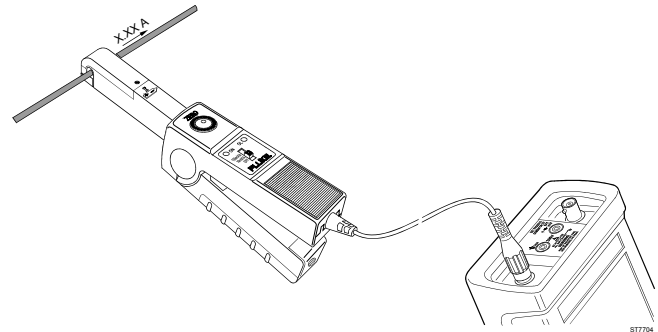



Figure 4. Measuring Setup

Measurement considerations

Observe the following guidelines for positioning the Current Probe Jaws:

- Center the conductor inside the probe jaws.
- Make sure the probe is perpendicular to the conductor.
- Make sure that the arrow marked  on the jaw of the Current Probe points toward the correct direction.

Observe the following guidelines when making measurements:

- If possible, avoid measurements close to other current-carrying conductors.
- On the Current Probe, the 100 mV/A range offers the best accuracy.

Maintenance

Before each use, assure continued safety by inspecting the probe. Look for cracks or missing portions of the probe housing and output cable insulating cover and for loose or weakened components. Pay particular attention to the insulation surrounding the probe jaws. If a probe fails this inspection, tape it shut to prevent unintended operation. To check probe performance, complete the "Performance Verification" procedure.



Warning

These servicing instructions are for use by qualified personnel only. To avoid electric shock, do not perform any servicing procedures unless you are qualified to do so. Read the information titled "Safety Information" at the beginning of this instruction sheet before proceeding.

Repairs or servicing not covered in this Users Manual should be performed only at a Fluke Service Center. A probe under warranty will be promptly repaired or replaced (at Fluke's discretion) and returned at no charge.

Cleaning and storage

Periodically wipe the case with a damp cloth and detergent; do not use abrasives or solvents. Open the jaws and wipe the magnetic pole pieces with a lightly oiled cloth. Do not allow rust or corrosion to form on the magnetic core ends. If the probe is not used for periods of longer than 60 days, the battery should be removed and stored separately.

Performance verification

Verify probe accuracy with the test setup shown in Figure 5. Required test equipment is defined in Table 1. Toroid coil construction is illustrated in Figure 6.

Do the following to verify the probe accuracy:

- Set up Connection.
- Make the checks called for in Table 2 (100 mV/A).
- Make the checks called for in Table 3 (10 mV/A).

Table 1. Required Test Equipment

| REQUIRED | RECOMMENDED MODEL |
|-----------------------------|------------------------|
| AC/DC Calibrator | Fluke Model 5520A |
| Digital Multimeter (DMM) | Fluke Model 45 |
| Small insulated screwdriver | Spectrol |
| Banana-to-BNC Adapter | Fluke Model PM9081/001 |
| 10-Turn Toroid Coil | (see Figure 6.) |

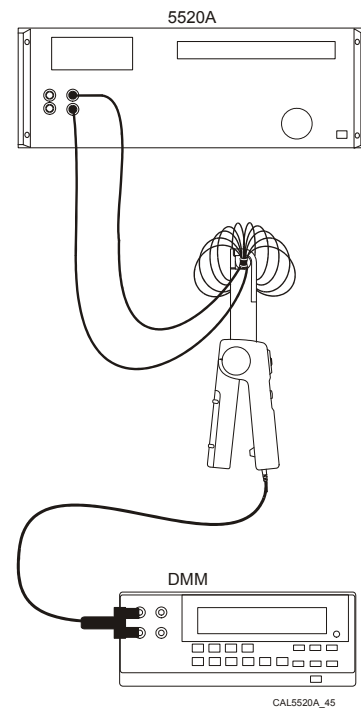

Figure 5. Performance Test and Calibration Setup

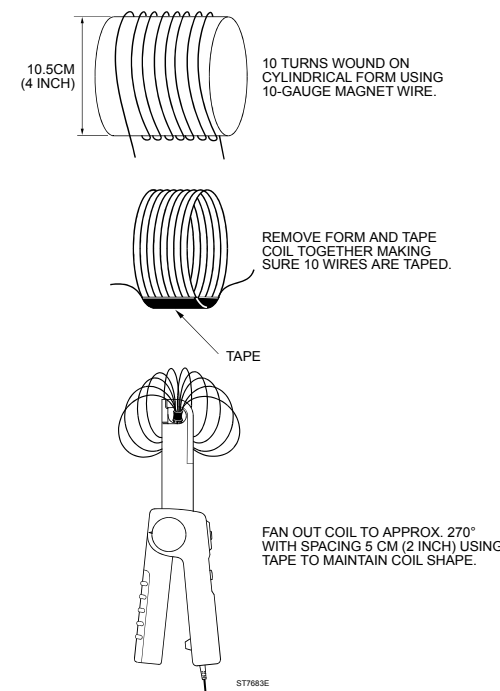

Figure 6. Toroid Coil Construction

Table 2. Performance Test Points

Current range 0 to 10A (100 mV/A)

DC Measurement:

| 5520A SETTINGS | DC AMPS MEASURED | LOW LIMIT OUTPUT | HIGH LIMIT OUTPUT |
|----------------|------------------|------------------|-------------------|
| 0.1A | 1A | 92 mV | 108 mV |
| 0.5A | 5A | 480 mV | 520 mV |
| 0.9A | 9A | 868 mV | 932 mV |

AC Measurement:

| 5520A SETTINGS | RMS AMPS MEASURED | LOW LIMIT OUTPUT | HIGH LIMIT OUTPUT |
|----------------|-------------------|------------------|-------------------|
| 0.1A, 60 Hz | 1A | 92 mV | 108 mV |
| 0.3A, 400 Hz | 3A | 286 mV | 314 mV |
| 0.5A, 2 kHz | 5A | 465 mV | 535 mV |
| 0.6A, 4 kHz | 6A | 559 mV | 641 mV |

Table 3. Performance Test Points

Current Range 0 to 100A (10 mV/A)

DC Measurement:

| 5520A SETTINGS | DC AMPS MEASURED | LOW LIMIT OUTPUT | HIGH LIMIT OUTPUT |
|----------------|------------------|------------------|-------------------|
| 1A | 10A | 95.5 mV | 104.5 mV |
| 3A | 30A | 287.5 mV | 312.5 mV |
| 5A | 50A | 439.5 mV | 560.5 mV |
| 7A | 70A | 615.5 mV | 784.5 mV |
| 9A | 90A | 765.0 mV | 1035.0 mV |

AC Measurement:

| 5520A SETTINGS | RMS AMPS MEASURED | LOW LIMIT OUTPUT | HIGH LIMIT OUTPUT |
|----------------|-------------------|------------------|-------------------|
| 1A, 5 kHz | 10A | 92.5 mV | 107.5 mV |
| 2A, 1 kHz | 20A | 185.5 mV | 214.5 mV |
| 3A, 400 Hz | 30A | 287.5 mV | 312.5 mV |
| 5A, 400 Hz | 50A | 439.5 mV | 560.5 mV |
| 7A, 60 Hz | 70A | 595.0 mV | 805.0 mV |

If Your Current Probe Does Not Work

If the 80i-110s does not perform properly, use the following steps to help isolate the problem:

- Test the battery: be sure that the green ON-indicator lights when you select the 10 mV/A range or the 100 mV/A range.
- Inspect the jaw mating surface for cleanliness. If any foreign material is present, the jaws will not close properly and errors will result.
- Verify that the probe is zeroed properly. For zeroing be sure that the ScopeMeter test tool or oscilloscope is DC-coupled.
- Verify that the function selection on the ScopeMeter test tool or oscilloscope is correct, i.e., the display vertical resolution is not too low or too high.

Replacement Parts

To order replacement parts in the USA, call 1-800-526-4731. To order outside the USA, contact the nearest Service Center. Use the following part numbers:

| Description | Part Number |
|----------------------------|----------------|
| 9 Volt Battery (IEC 6LR61) | 4822 138 10116 |
| Battery Cover | 5322 447 92322 |
| Instruction Sheet | 4822 872 30777 |

Order Fluke Part PM9081/001 BNC-to-Banana Adapter to use the Current Probe with a digital multimeter.

LIMITED WARRANTY & LIMITATION OF LIABILITY

This Fluke product will be free from defects in material and workmanship for one year from the date of purchase. This warranty does not cover fuses, disposable batteries or damage from accident, neglect, misuse or abnormal conditions of operation or handling. Resellers are not authorized to extend any other warranty on Fluke's behalf. To obtain service during the warranty period, send your defective product to the nearest Fluke Authorized Service Center with a description of the problem.

THIS WARRANTY IS YOUR ONLY REMEDY. NO OTHER WARRANTIES, SUCH AS FITNESS FOR A PARTICULAR PURPOSE, ARE EXPRESSED OR IMPLIED. FLUKE IS NOT LIABLE FOR ANY SPECIAL, INDIRECT, INCIDENTAL OR CONSEQUENTIAL DAMAGES OR LOSSES, ARISING FROM ANY CAUSE OR THEORY.

Since some states or countries do not allow the exclusion or limitation of an implied warranty or of incidental or consequential damages, this limitation of liability may not apply to you.

Fluke Corporation
P.O. Box 9090
Everett WA
98206-9090, USA

Fluke Industrial B.V.
P.O. Box 90
7600 AB Almelo
The Netherlands

SERVICE CENTERS

To locate an authorized service center, visit us on the World Wide Web:

<http://www.fluke.com>

or call Fluke using any of the phone numbers listed below:

+1-888-993-5853 in U.S.A. and Canada

+31-40-267-5200 in Europe

+1-425-446-5500 from other countries