

User's Guide

LA5034

Operation Manual

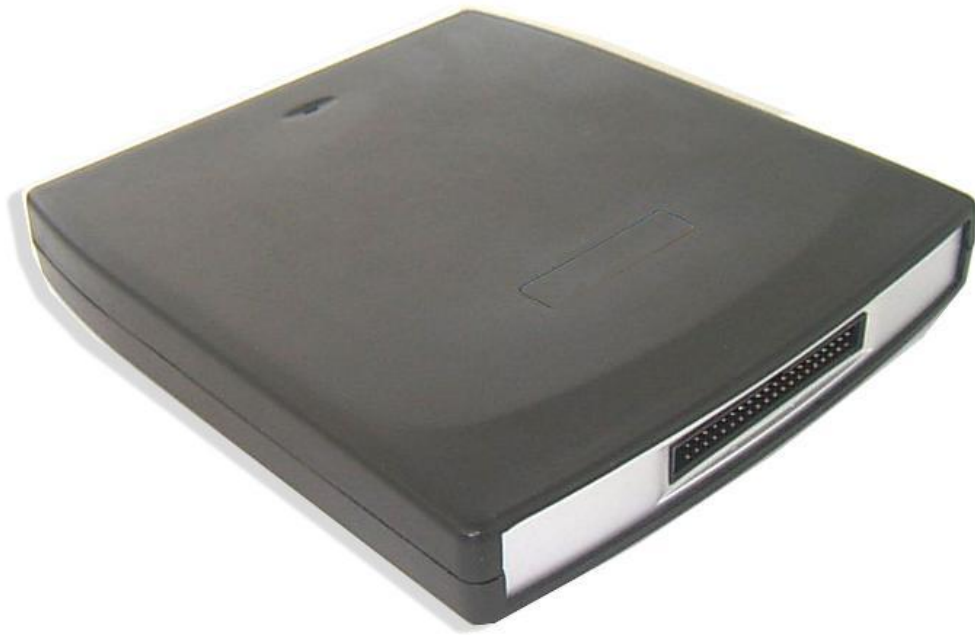

Content

General safety summary	I
Introduction.....	II
Chapter 1 Getting started	1
System Requirements.....	2
Installing Hardware	3
Installing Software.....	6
User Interface	10
Chapter 2 Menu.....	11
File	12
View	13
Setup.....	14
Analyzer.....	15
Help.....	16
Chapter 3 Advanced.....	17
Clock Panel.....	18
Bus Panel.....	19
Waveform Panel.....	22
Measurement Panel.....	24
Export Data	25
Chapter 4 Trigger	26
Base Trigger Setup	27
Advance Trigger Setup.....	29
Chapter 5 Plug Manager	30
Summary.....	31
Example	32
Appendix	33
Hardware Specification	34
Channels.....	35
Block Diagram.....	37
Cleaning and maintenance	38

General safety summary

Understand the following safety precautions to avoid injuries and to prevent damage to the product or the product of any product link. To avoid possible dangers, be sure to use the product in accordance with the regulations.

- n **Only qualified personnel to perform maintenance procedures.**
- n **Prevent fire and personal injury.**
- n **Use the right power cord.** Only the country in which the authorized use of this product for the power line.
- n **Correctly inserted.** Probe or test voltage wire connected to the source, please do not plug.
- n **Products will be grounded.** This product through the power of the grounding wire grounding. To avoid electric shocks, grounding conductor must be connected to. In this connection the import or export of products before the end, be sure to correct grounding for this product.
- n **Properly connected probe.** Probe the ground with the same potential. Do not connect high-voltage ground.
- n **See all the terminals rating.** To avoid excessive current fire and the impact, see the product of all the ratings and tags; please connect products in the product manual inspection prior to understand the detailed ratings information.
- n **Do not run the product if you open the cover or panel.**
- n **Avoid the exposed circuit.** Do not connect power after contact with the exposed joints and components.
- n **Suspected products to failure do not operate.** If you suspect that this product has been a failure, can be qualified maintenance personnel to be checked.
- n **Maintain proper ventilation.**
- n **Do not operate in the humid environment.**
- n **Do not flammable and explosive environment operation.**
- n **Please keep the product clean and dry surface.**

Introduction

The LA5034 is a sophisticated 500MHz, 34-channel logic analyzer used for testing, analysis, and troubleshooting of digital circuits. The LA5034 is equipped with features found only in more expensive bench type instruments. The use of advanced large-scale integrated circuits, integrated USB 2.0, CPLD, FPGA, high-frequency digital circuitry, embedded systems, and other advanced technology, make the LA5034 to be portable, and easy-to-use, making the LA5034 your best choice in pc-based logic analyzers. The LA5034 is very suitable for electronic measurement engineers, college students in scientific research and development and teaching assistants. The User's Manual describes in detail the operation of the LA5034 as well as installation of the software.

The LA5034 has a sufficient number of input channels and is capable of simultaneously observing a lot of information or data flow direction control information, and in some way of capturing narrow pulse interference.

The LA5034 has the feature of delayed ability to capture the required observation points around the waveform, in a variety of digital information capture function.

The LA5034 has adequate memory capacity to be both display error messages and to find faults in the source state.

The LA5034 has intuitive and flexible displays to facilitate dynamic analysis, can transform the information, and the user can use the binary, decimal, hexadecimal or ASCII that information to facilitate the repair process and debug.

The LA5034 can be triggered in a variety of ways, can display a very long data stream, on the basis of the analysis of that part of the information to make accurate positioning, and capture appropriate information for software analysis by using its tracking function trigger operation procedures. For hardware, trigger function can be detected in the system and that the interference and Burr.

The LA5034 has reliable Burr detection ability. As competition in digital circuit, the signal crosstalk, interference and power coupling factors, often mixed with irregular signal in the burr, which will run from an incorrect circuit. The LA5034 can detect through special burr technology to capture and display.

Chapter 1 Getting started

This chapter focuses on the following topics:

- u System Requirements
- u Installing hardware
- u Installing software
- u Understanding of the user interface

System Requirements

I Minimum System Requirements

Operating System

Windows NT/2000/XP/Vista

Memory

128MB

Graphic Card

Microsoft DirectX supported

Screen resolution: 1024x768

Color depth: 16bit

I Recommended System Requirements

Operating System

Windows NT/2000/XP/Vista

Memory

256MB

Graphic Card

Microsoft DirectX supported

Screen resolution: 1024x768

Color depth: 16bit

Installing Hardware

1. Connect the A-Type Plug of USB cable to your PC's USB port.
2. Connect the B-Type Plug of USB cable to LA5034's USB port.
3. New hardware is found.



4. New hardware search wizard starts.



5. New hardware search wizard starts to search

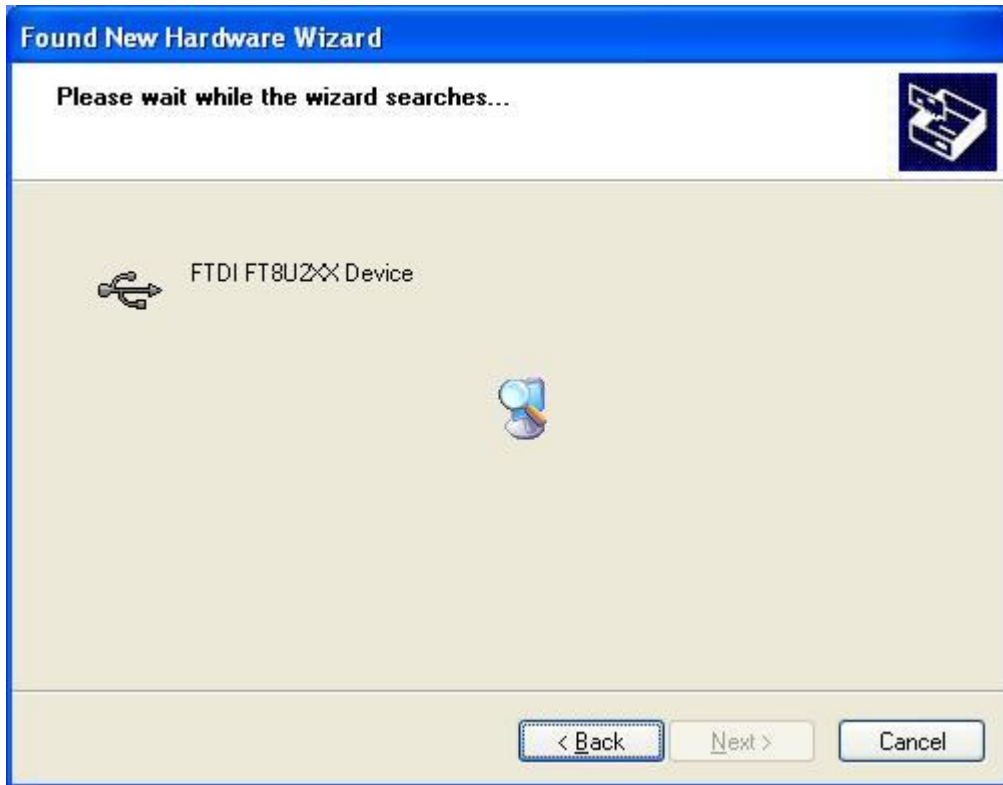

6. New hardware wizard installs software



7. Finish new hardware search wizard.

**Caution:**

Do not disconnect any device from the USB bus while the computer is communicating with the LA5034, or you may lose data and/or your ability to communicate with the LA5034.

If the LED is illuminated but the turns off, the computer has lost communication with the LA5034. To restore communication, disconnect the USB cable from the computer, and then reconnect it. This should restore communication, and the LED should turn back on.

Installing Software

1. While in Windows, insert the installation CD into the CD-ROM drive.
2. The installation should start up automatically. Otherwise in Windows Explorer, switch to the CD-ROM drive and run "Setup.exe".



3. The LA5034 Installation is started. Click 'Next' to continue.

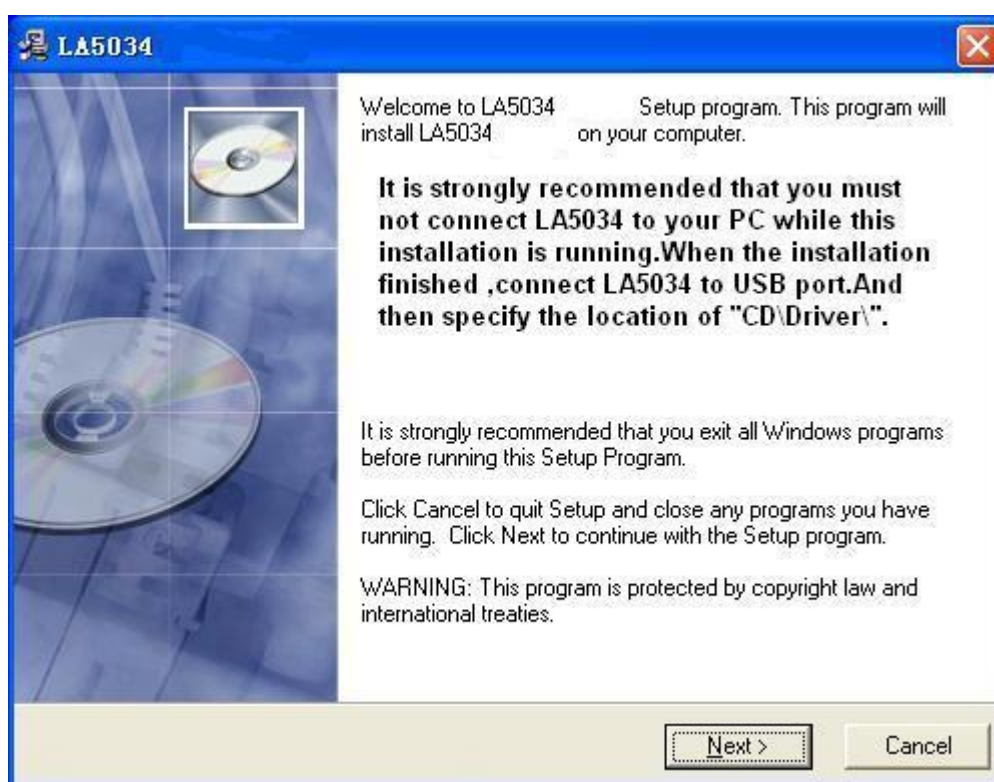

4. Choose a destination directory. Click 'Next' to continue.

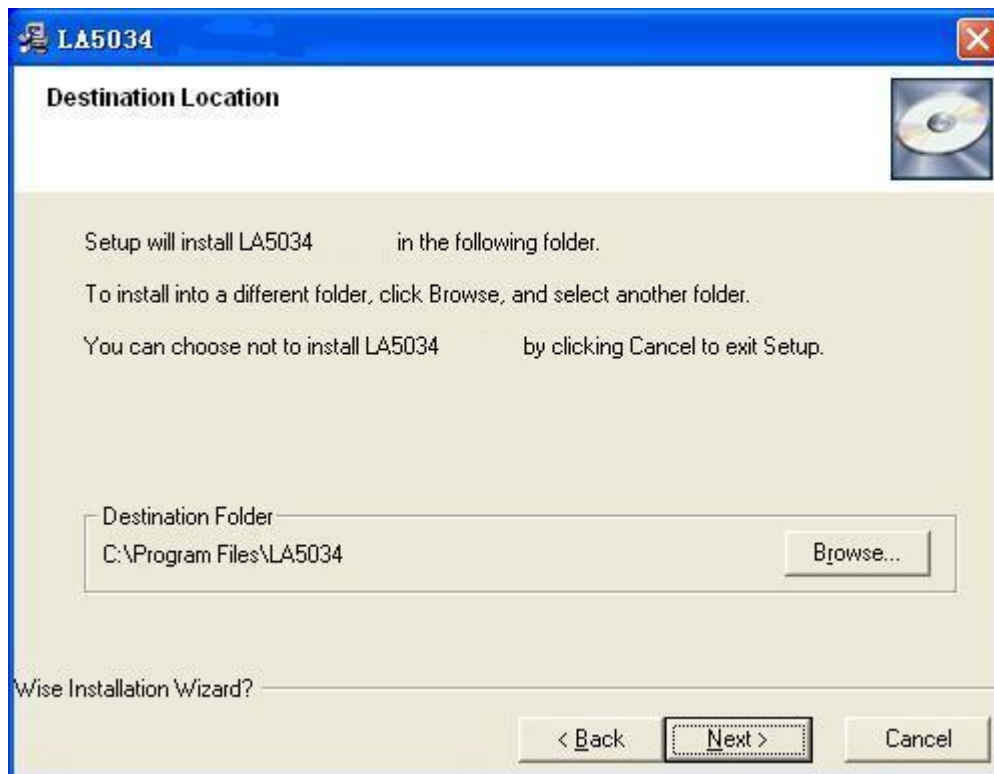

5. Check the setup information. Click Next to start copying of files.

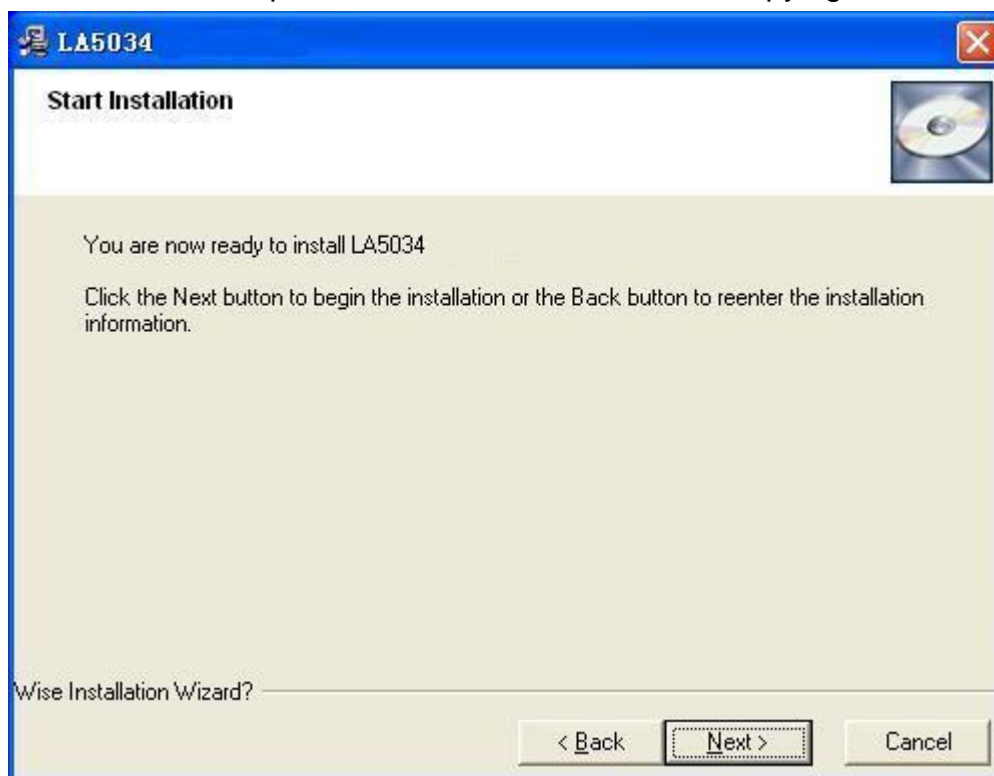

6. This Status dialog is displayed during copying of files.

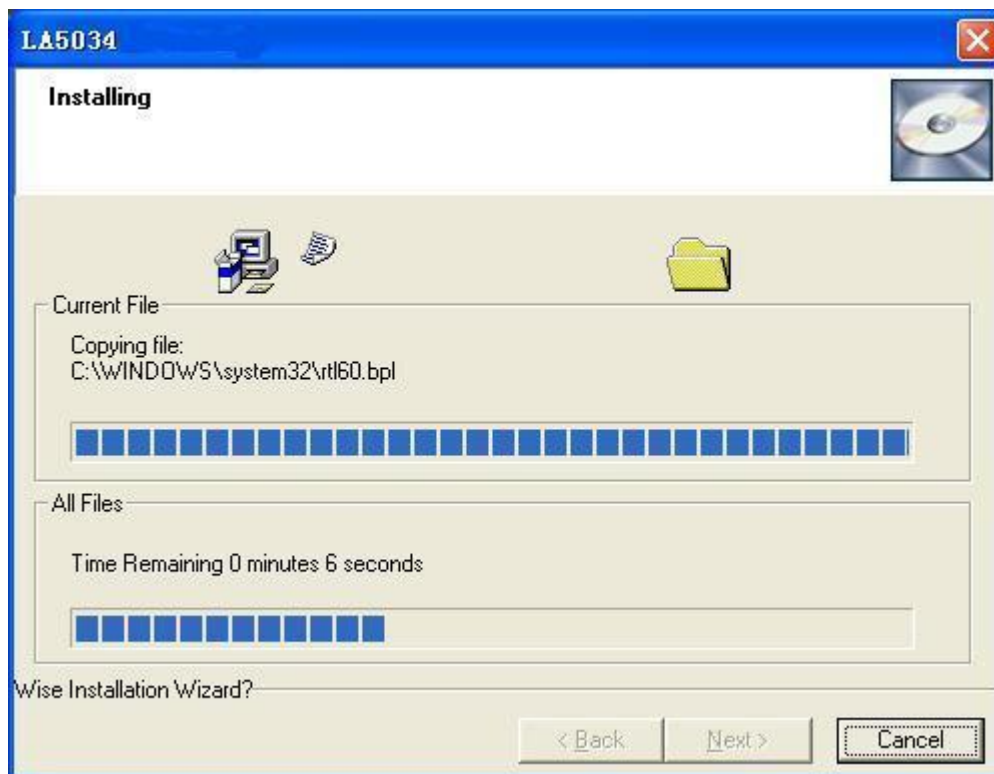

7. Updating Your System Configuration.

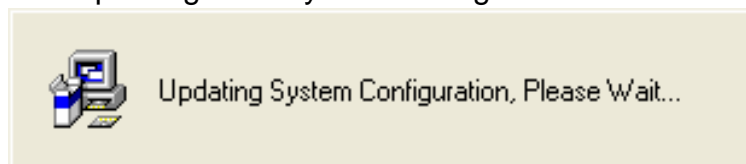

8. The installation is complete.

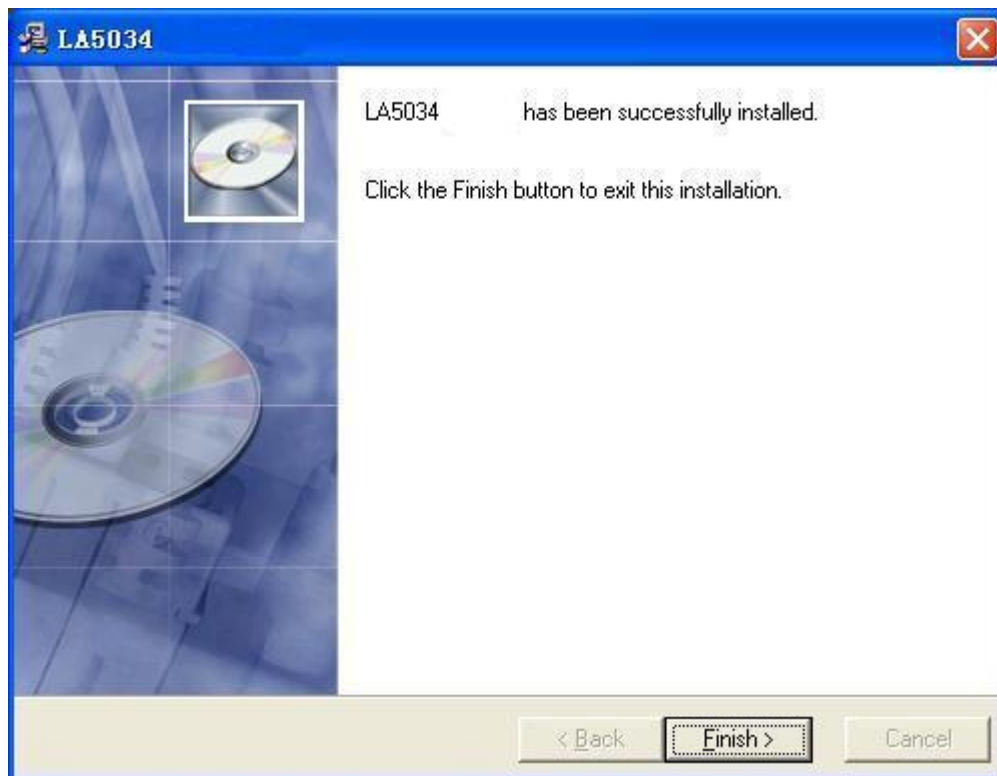

User Interface

LA5034 provide users a simple and full-featured interface so that users do not have to spend a lot of time to learn.

LA5034 provide clock panel, waveform panel, bus panel, measurement panel, trigger panel and plug manager.

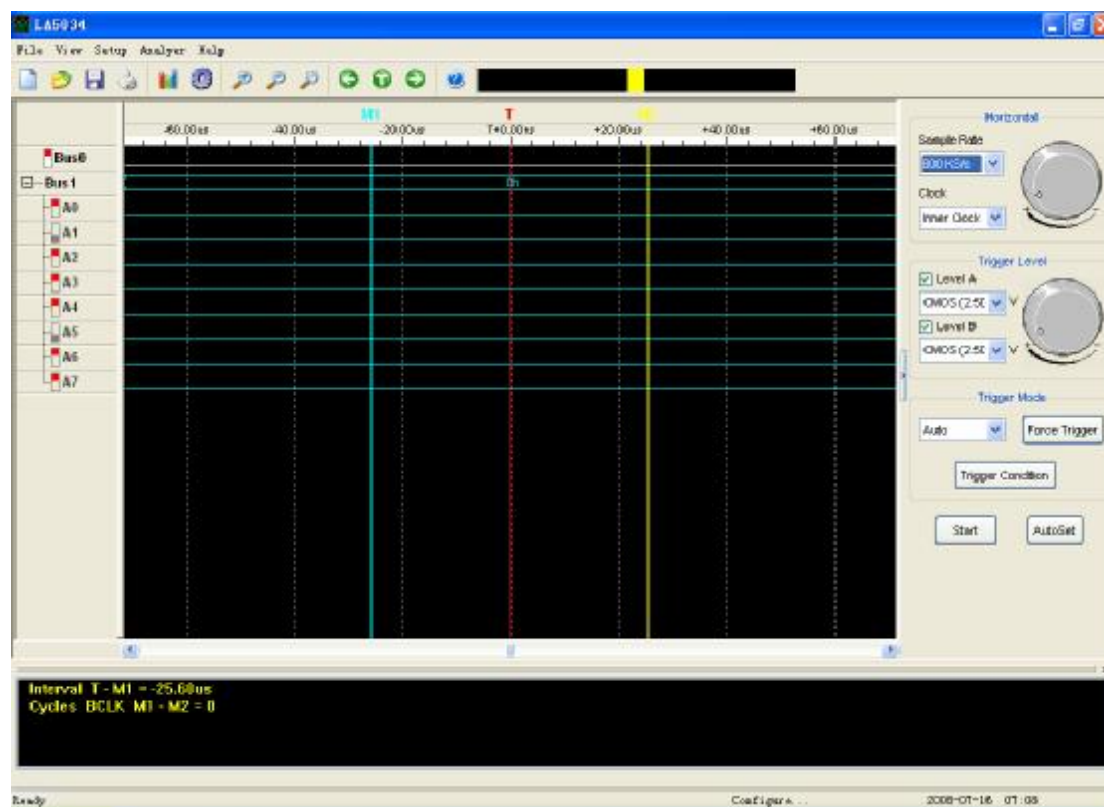

Chapter 2 Menu

This chapter focuses on the following topics:

- u File
- u View
- u Setup
- u Analyzer
- u Help

File

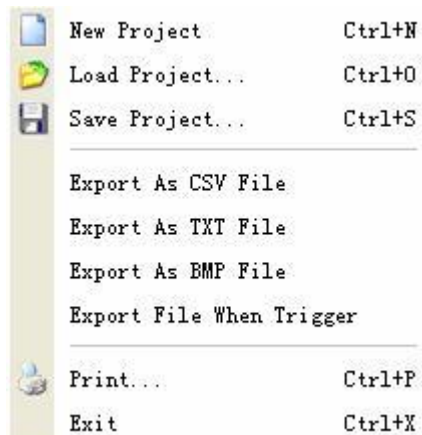

- I **New Project:** Create a new project with default settings
- I **Load Project:** Open an exist project
- I **Save Project:** Save current project to File
- I **Export As CSV File:** Export data to file as “CSV”
- I **Export As TXT File:** Export data to file as “TXT”
- I **Export As BMP File:** Export data to file as “BMP”
- I **Export File When Trigger:** Export data to file when trigger.
- I **Print...:** Print the current waveform
- I **Exit:** Exit LA5034

View

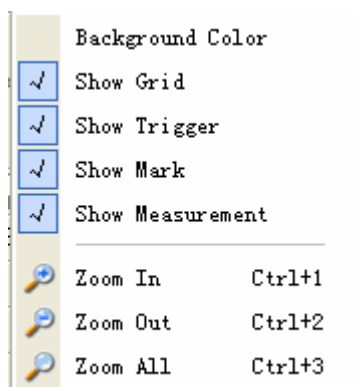

- | | | |
|--|--------------------------|---|
| | Background Color: | Modify the background color of waveform. |
| | Show Grid: | Show or hide the grid of waveform |
| | Show Trigger: | Show or hide the trigger line of waveform |
| | Show Mark: | Show or hide the mark of waveform |
| | Show Measurement: | Show or hide the measurement of waveform |
| | Zoom In: | Enlargement waveform view |
| | Zoom Out: | Reduction waveform view |
| | Zoom All: | Show entire waveform view |

Setup

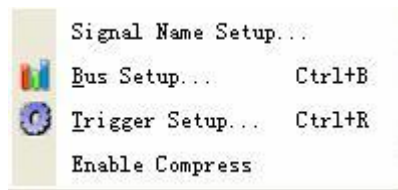

- I **Signal Name Setup:** Configure the names of signal.
- I **Bus Setup:** Configure the bus and signals.
- I **Trigger Setup:** Configure the trigger condition.
- I **Enable Compress:** Set the compress enable or not.

Analyzer

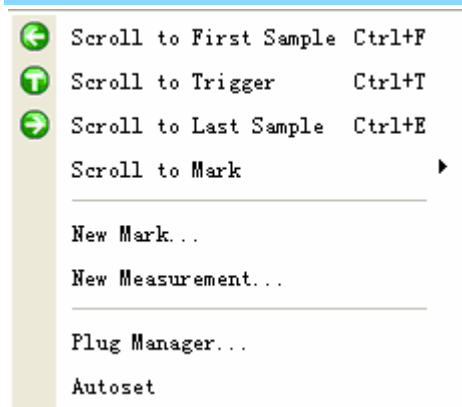

- | | | |
|---|--------------------------------|---|
| I | Scroll to First Sample: | Causes the waveform view to roll to the first sample position |
| I | Scroll to Trigger: | Causes the waveform view to roll to trigger position. |
| I | Scroll to Last Sample: | Causes the waveform view to roll to the last sample position |
| I | Scroll to Mark: | Causes the waveform view to roll to the mark position |
| I | New Mark: | Create a new Mark |
| I | New Measurement: | Create a new measurement. |
| I | Plug Manager: | Configure the plug of LA5034 |
| I | Auto set: | Set the waveform optimal. |

Help

-  Help Content
- About

- I **Help Content:** Open the User Manual
- I **About:** Show the copyright of LA5034

Chapter 3 Advanced

This chapter focuses on the following topics:

- u Clock Panel
- u Bus Panel
- u Waveform Panel
- u Measurement Panel
- u Export Data

Clock Panel

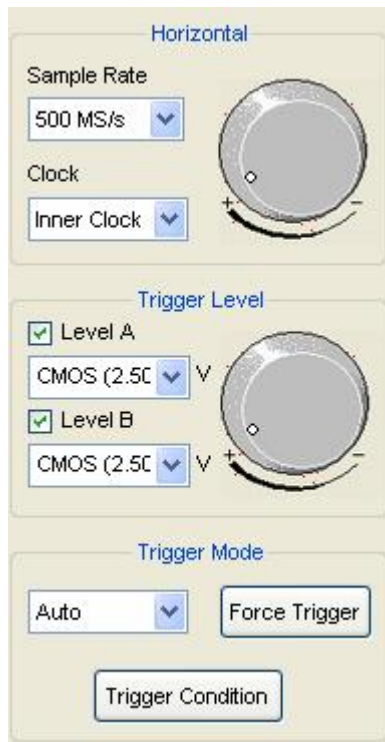

I Horizontal:

Set the clock and sample rate

Inner Clock: When inner clock is chosen, the LA5034 will sample at a rate specified by the “Sample Rate” combo box.

Ext Clock: When ext clock is chosen, you can select which clock input will be used for sampling.

I Trigger Level:

Configure the input trigger level.

I Trigger Mode:

Auto: Trigger continuously ignores trigger condition.

Normal: Trigger continuously under the trigger condition.

Single: Trigger under the trigger condition once.

Force Trigger: Trigger immediately once.

Trigger Condition: Pop up the trigger setup dialog.

Bus Panel

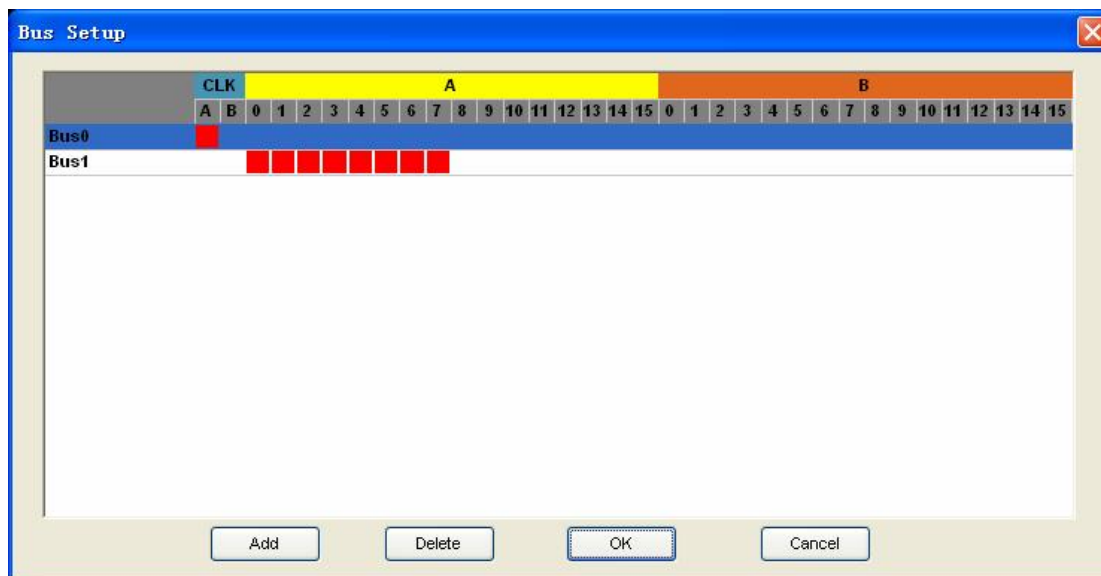

Click the menu “Setup”->”Bus Setup...” to open the dialog.

LA5034 has 34 signals, ACK, BCLK, A0 ~A15, B0~B15. You can assign the parts of them to some bus.

The list box contains all of the bus; you can add or delete the bus.

For example: Assign a bus “My Bus” which has 8 signals “ACLK, A0, A1, A2, A3, A4, A5, and A6 “.

1. Click the button “Add”. Then a new bus is added to the list.

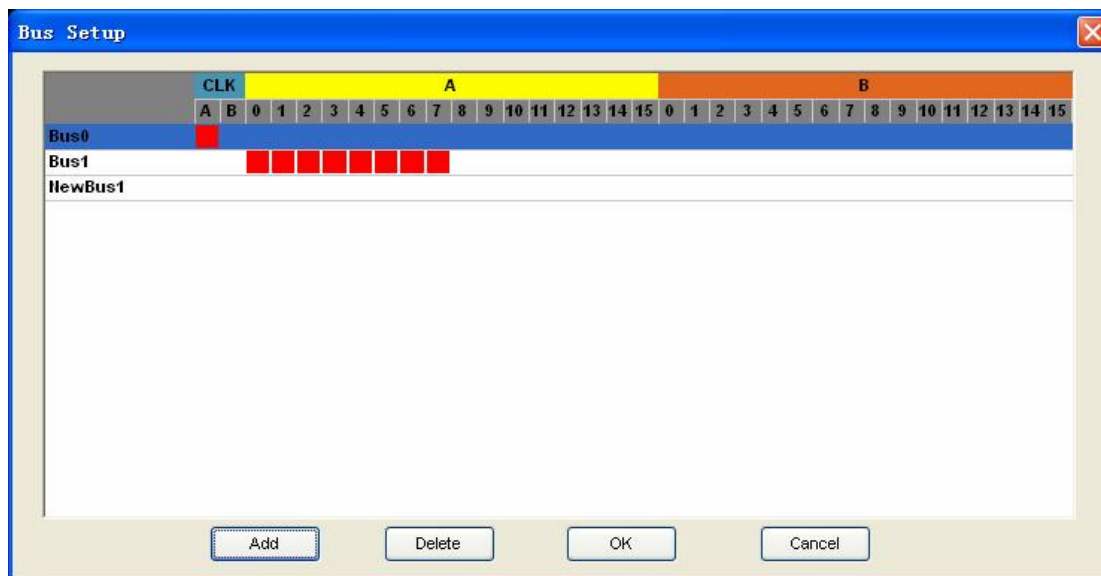

2. Click the pane under the CLKA, A0, A1, A2, A3, A4, A5, and A6. if the pane is filled of red, is means you have add the signal to the bus.

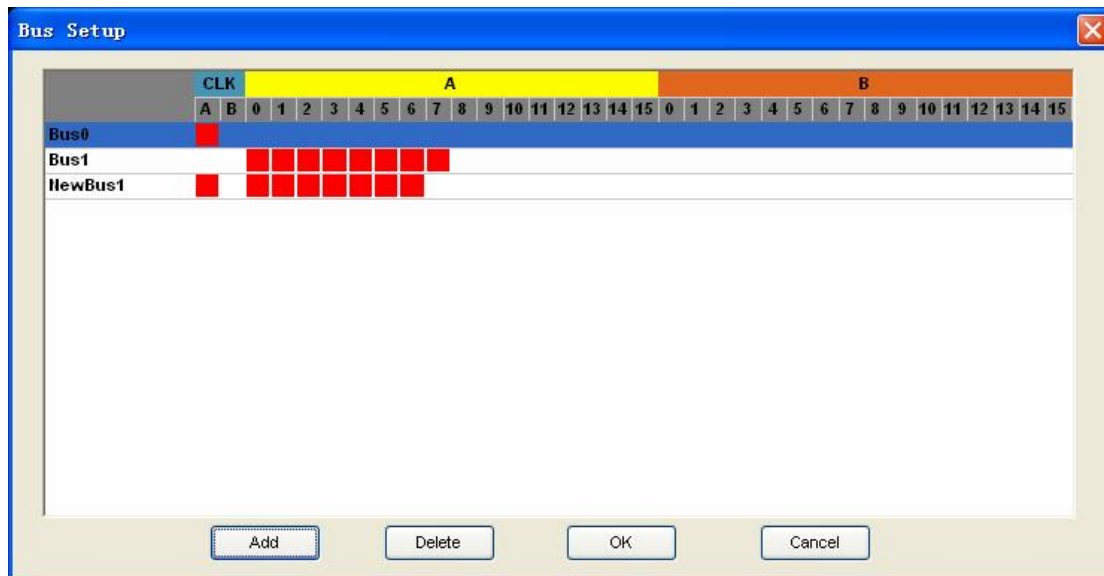

3. Double-click the name of the bus, which is “NewBus1” in this example. Then popup an edit box, in which you can input the bus name “My Bus”.

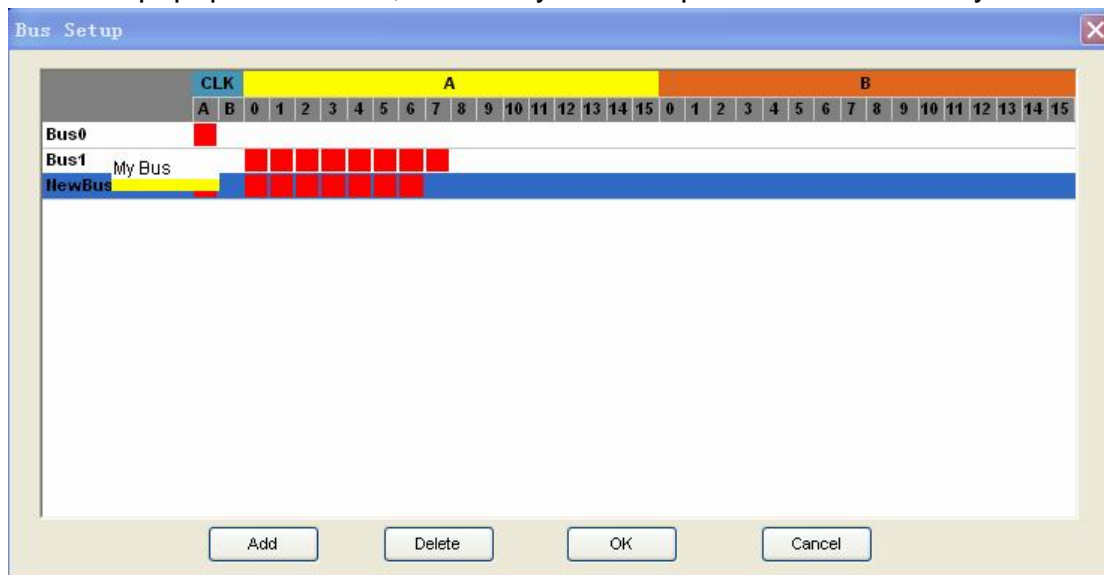

4. Then Click “OK”, the “My bus” has been added to the waveform.

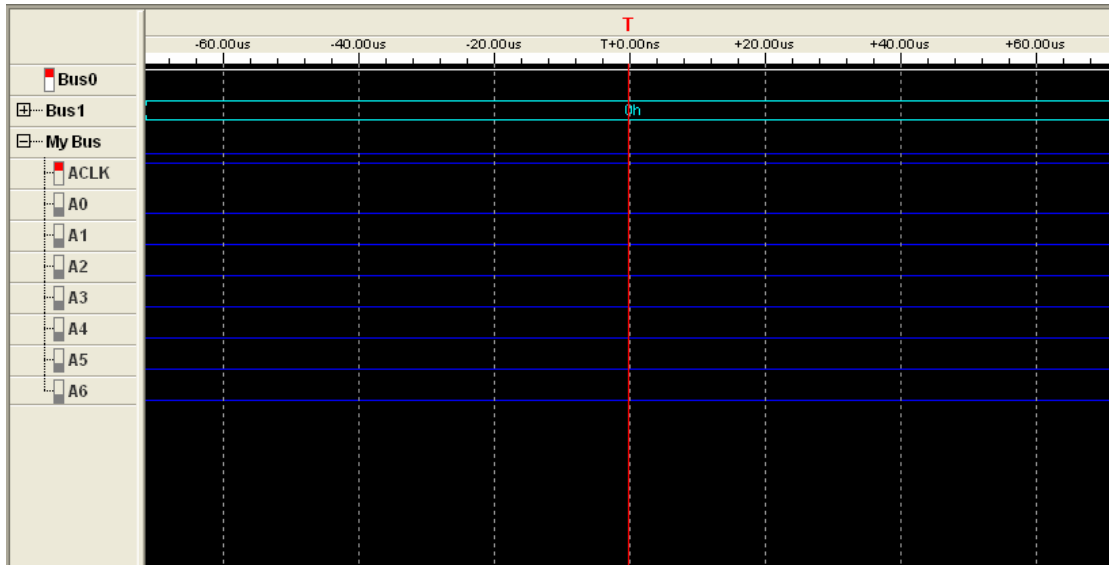

Waveform Panel

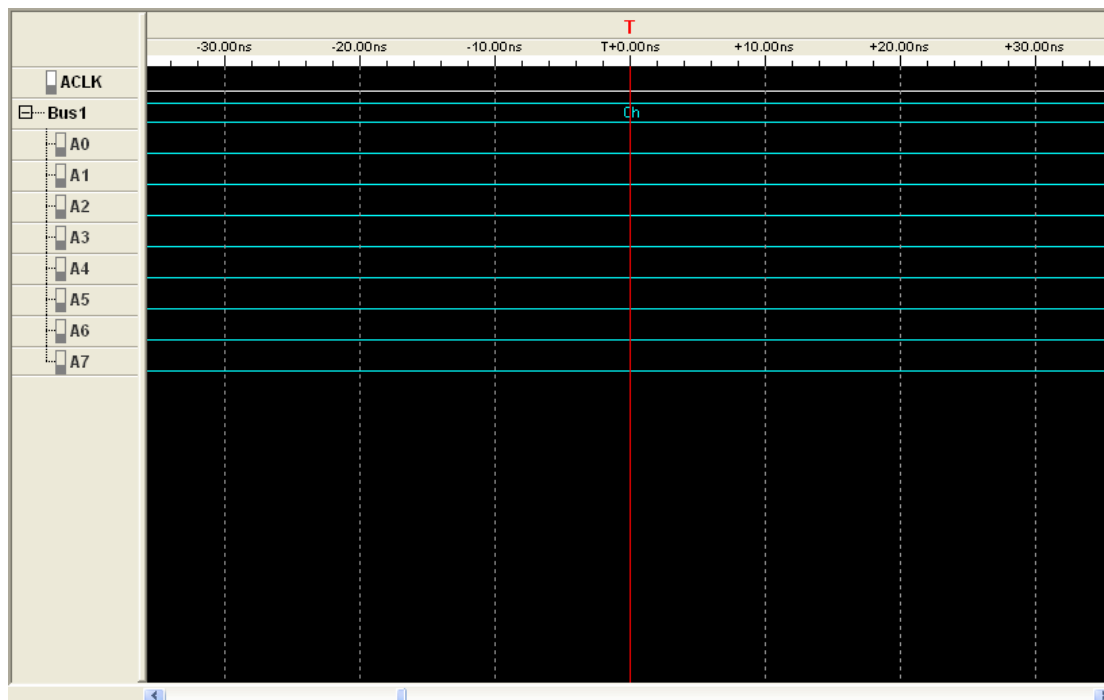

You can observe the waveform by the waveform panel in the main window. The list contains all of the bus in bus panel in the left part of the waveform panel.

Click the name of the bus with the right mouse button, you can configure the bus.

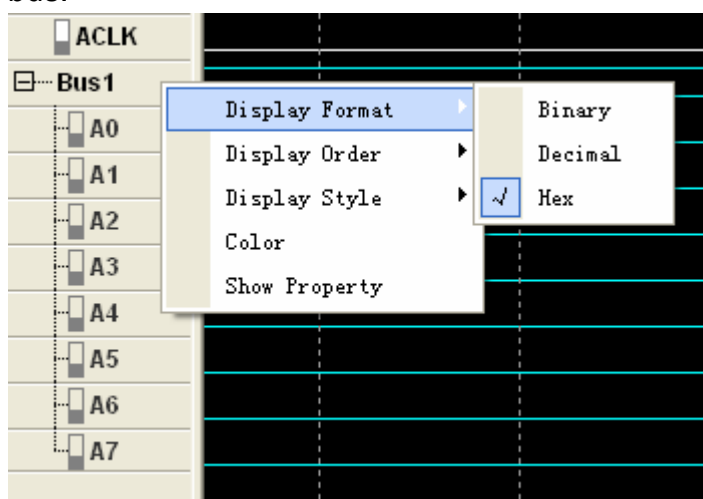

1. **Display Format:** The format of the bus data displayed on the waveform.
2. **Display Order:** The order of the signals displayed in the list.
3. **Display Style:** You can set the display style of the bus in the waveform, Analog or Digital.
4. **Color:** You can modify the color of the bus displayed in the waveform.

5. **Show Property:** Open the bus setup panel.

Click the waveform with the right mouse button, the waveform help menu popup. You can operate the LA5034 by the menu.

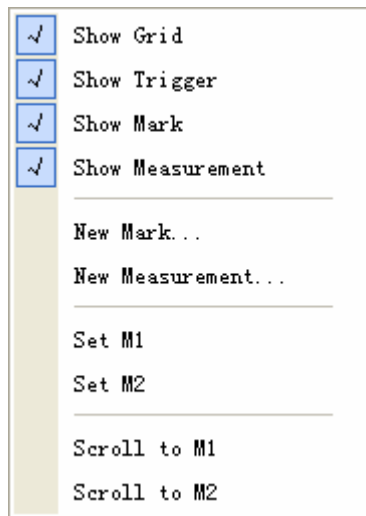

Measurement Panel

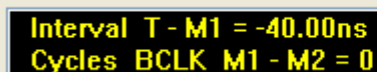

Interval T - M1 = -40.00ns
Cycles BCLK M1 - M2 = 0

Click the measurement panel with the right mouse button, then the menu popup.

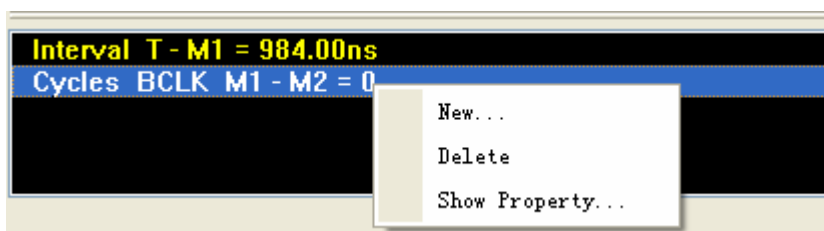

Click the “New” in the popup menu or “Analyzer”->”New Measurement” in the main menu, you will add a new measurement to the list in the measurement panel.



Select the “Measure” combo box. You can modify the types of measurement. There are 4 types for you, such as Interval, rate, transitions and cycles.

Click the “Delete”; you can delete the measurement item selected in the list. Click the “Show Property”; you can modify the measurement.

Also, you can click the main menu “Analyzer”->”New Mark” to add new mark for measurement.

Export Data

Export As CSV File

Export As TXT File

Export As BMP File

Click the menu “File”; you can export the data to file.



Data.csv



Data.txt



Data.bmp

If you select the CSV file, you will export the data as the following.

	A	B	C	D	E	F	G	H	I	J	K
1	Sample PeTrigger	CompressData									
2	500 MS/s	2048	FALSE								
3	Sample N	NewGroup1	ACLK	BCLK	A0	B0	A1	B1	A2	B2	NewGroup2
4	0	ffh	1	1	1	1	1	1	1	1	111h
5	1	ffh	1	1	1	1	1	1	1	1	111h
6	2	ffh	1	1	1	1	1	1	1	1	111h
7	3	ffh	1	1	1	1	1	1	1	1	111h
8	4	ffh	1	1	1	1	1	1	1	1	111h
9	5	ffh	1	1	1	1	1	1	1	1	111h
10	6	ffh	1	1	1	1	1	1	1	1	111h
11	7	ffh	1	1	1	1	1	1	1	1	111h
12	8	ffh	1	1	1	1	1	1	1	1	111h
13	9	ffh	1	1	1	1	1	1	1	1	111h
14	10	ffh	1	1	1	1	1	1	1	1	111h
15	11	ffh	1	1	1	1	1	1	1	1	111h
16	12	ffh	1	1	1	1	1	1	1	1	111h
17	13	ffh	1	1	1	1	1	1	1	1	111h
18	14	ffh	1	1	1	1	1	1	1	1	111h
19	15	ffh	1	1	1	1	1	1	1	1	111h
20	16	ffh	1	1	1	1	1	1	1	1	111h

Chapter 4 Trigger

This chapter focuses on the following topics:

- u Base Trigger Setup
- u Advance Trigger Setup

Base Trigger Setup

Click the menu “Setup”->”Trigger Setup”, you can configure the trigger condition.

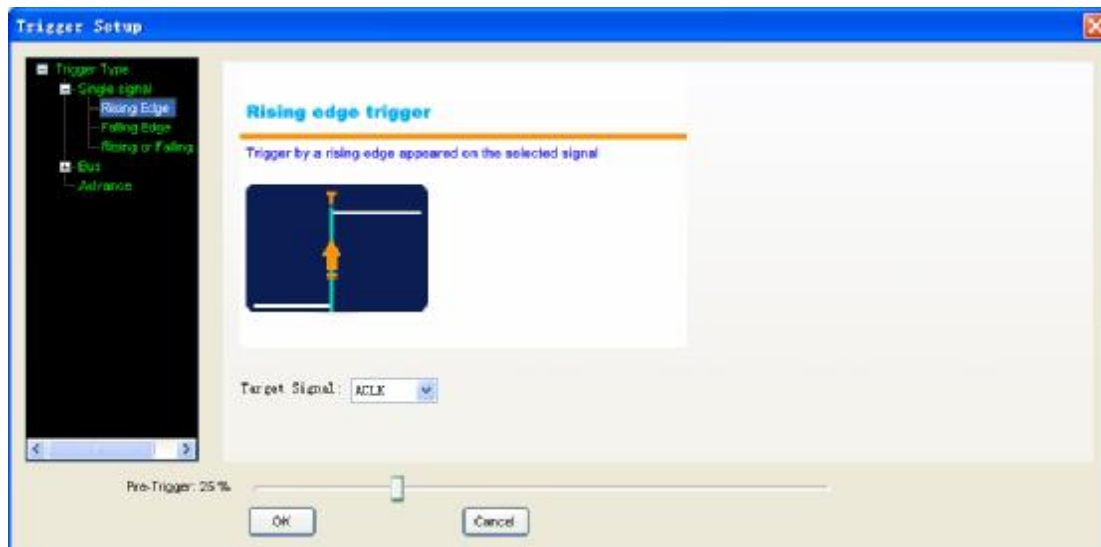

LA5034 provide 6 base triggers for you.

- I **Single signal:** Rising edge; Falling edge; Rising or falling edge.
- I **Bus:** Data, Data value delay, Data and edge

1. Rising edge:

Select the “Rising edge” in the tree; select the signal in the combo box. Then it will triggered by a rising edge appeared on the selected signal.

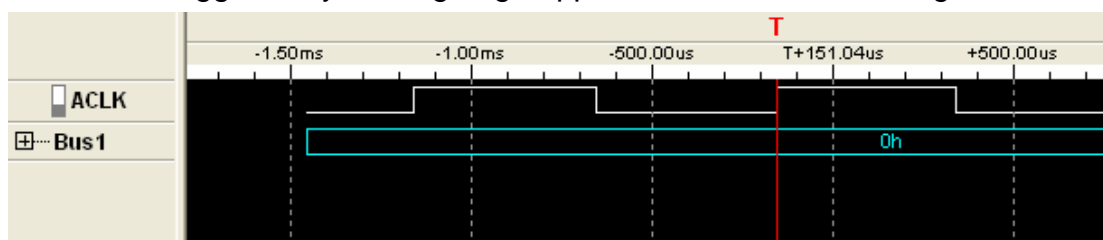

2. Falling edge:

Trigger by a falling edge appeared on the selected signal.

3. Rising or falling edge:

Trigger by a rising or falling edge appeared on the selected signal.

4. Data:

Trigger at the appearance of a specified value on the selected bus.

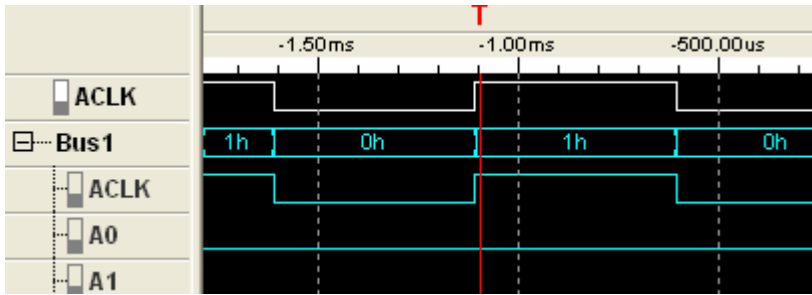

5. Data value delay:

Trigger at x time after the appearance of a specified value

6. Data and edge:

Trigger at the appearance of a specified value on the selected bus and rising, falling, or rising or falling edge of the selected signal.

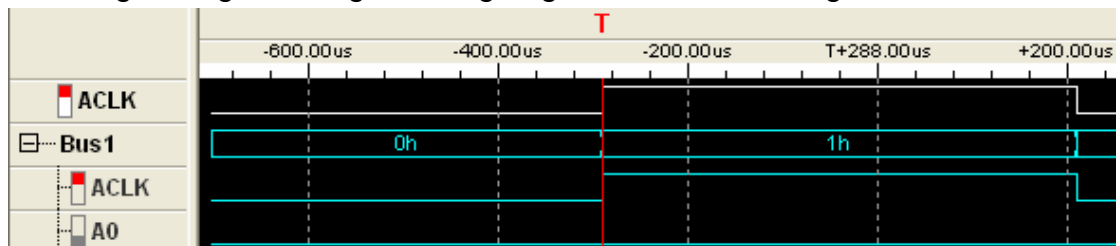

Advance Trigger Setup

If the base trigger can't satisfy you, maybe you want the advance trigger. Click the "Advance" in the tree, then you can configure the advance trigger.

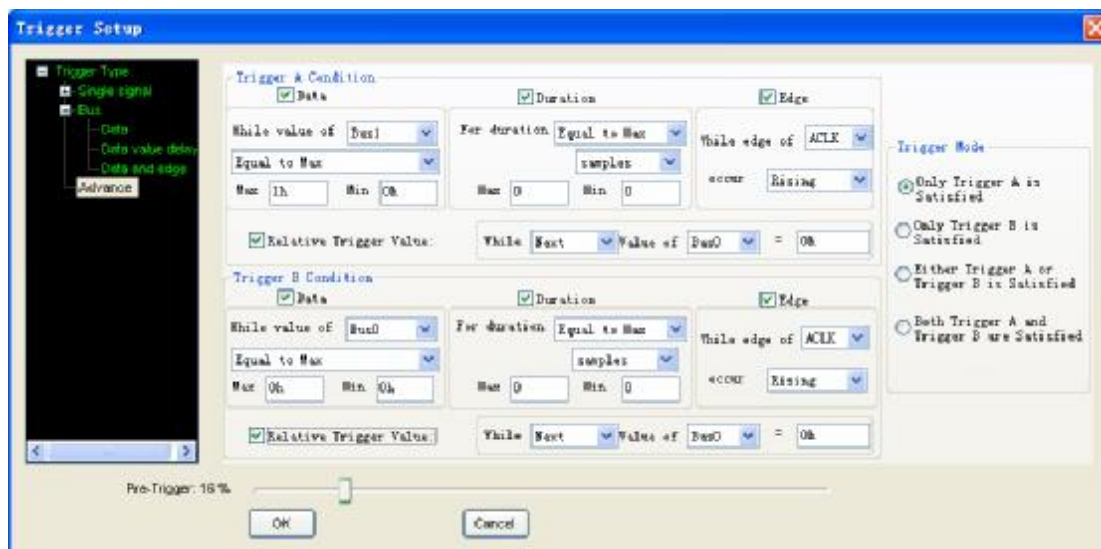

There are two trigger conditions: trigger A and trigger B. You can set the trigger mode by clicking the Trigger Mode group box.

There are four parts in each condition, Data, Duration, Edge and Relative trigger value.

Chapter 5 Plug Manager

This chapter focuses on the following topics:

- u Summary
- u Example

Summary

Click Menu “Analyzer”->”Plug Manager”.

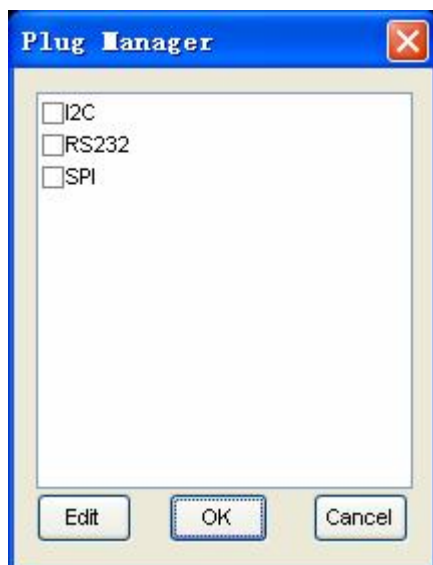

The list box contains all of the plugs installed in your computer. You can add them to waveform by checking them.

Select a plug and click the “Edit” button, you can modify the property of the plug.

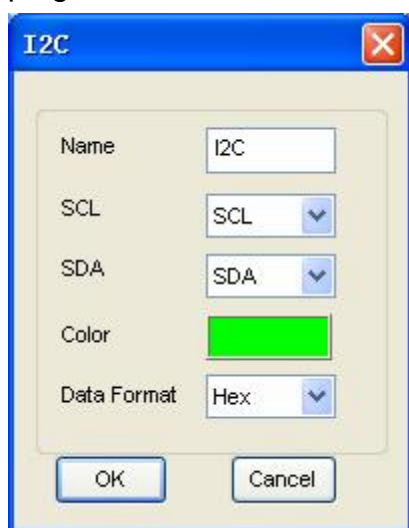

Example

If you want to analyze the I²C bus, you should go with the steps following.

1. Click menu "Setup"->"Bus Setup" or toolbar , open the bus setup dialog. Then add two buses which only have one signal.

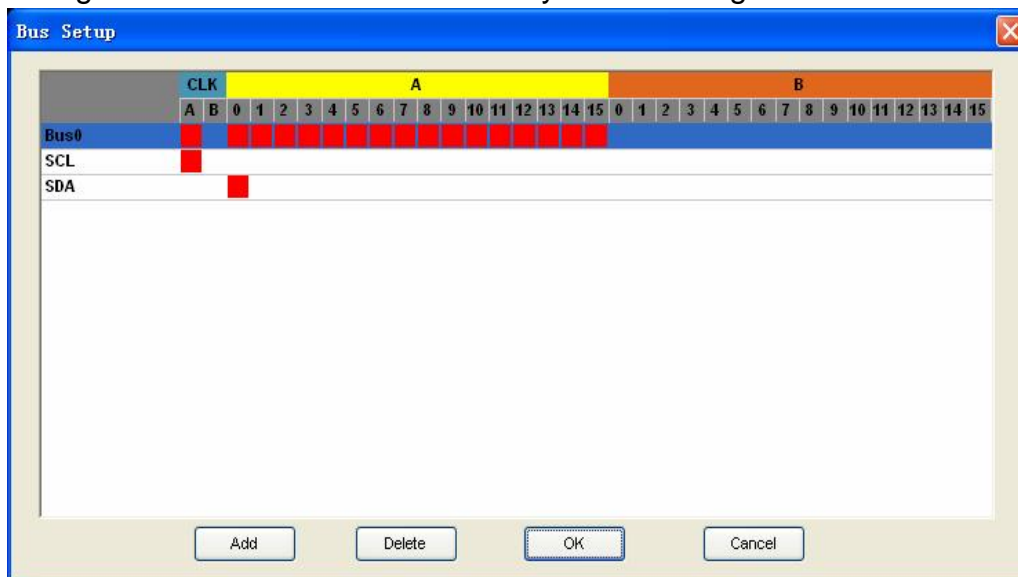

2. Open the plug manager and the I²C setup dialog. Click menu "Analyzer"->"Plug Manager", then select I²C and click the "Edit" button.

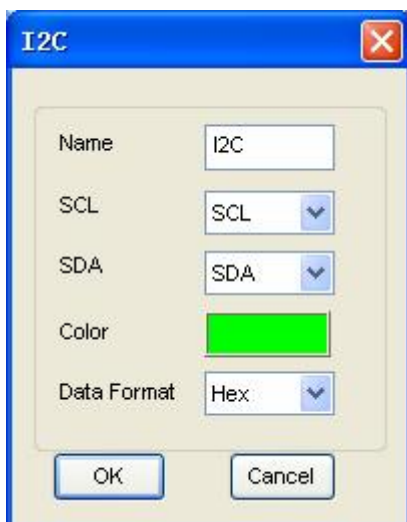

3. Then you can see the following.

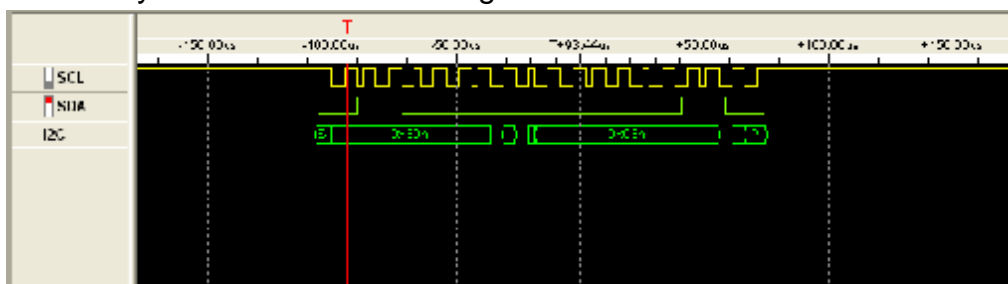

Appendix

- u Hardware specification
- u Input connector pin assignments
- u Block Diagram
- u Cleaning and Maintenance

Hardware Specification

Sampled channels	34
High input impedance	200K (C=10p)
Input voltage range	-60V~60V
Logic threshold Range	-6V~6V
Max Sample Rate	500 MHz
Max input Signal bandwidth	150 MHz
Min time resolution	2ns
Sample Depth	2KSample
Max record time (Compression mode)	10 hours
Max Sample Rate (Compression mode)	200 MHz
Trigger's Max rate	250 MHz
Compatible input	TTL,LVTTL,CMOS,LVCOMS,ECL,PECL,EIA
Electrostatic Protected	15KV
Power	USB Port
Temperature range	-10°C~60°C

Channels

Level A

Pin Number	Wire ID	Wire Color	Contact Color
1	Ground	Black	Black
2	ACLK	Blue	Blue
3	Ground	Black	Black
4	A0	Black	Yellow
5	A1	White	Yellow
6	A2	Gray	Yellow
7	A3	Blue	Yellow
8	A4	Green	Yellow
9	A5	Yellow	Yellow
10	A6	Orange	Yellow
11	A7	Red	Yellow
12	A8	Black	Yellow
13	A9	White	Yellow
14	A10	Gray	Yellow
15	A11	Blue	Yellow
16	A12	Green	Yellow
17	A13	Yellow	Yellow
18	A14	Orange	Yellow
19	A15	Red	Yellow
20	Ground	Black	Black

Level B

Pin Number	Wire ID	Wire Color	Contact Color
1	Ground	Black	Black
2	BCLK	Blue	Blue
3	Ground	Black	Black
4	B0	Black	Orange
5	B1	White	Orange
6	B2	Gray	Orange
7	B3	Blue	Orange
8	B4	Green	Orange
9	B5	Yellow	Orange
10	B6	Orange	Orange
11	B7	Red	Orange
12	B8	Black	Orange
13	B9	White	Orange
14	B10	Gray	Orange

15	B11	Blue	Orange
16	B12	Green	Orange
17	B13	Yellow	Orange
18	B14	Orange	Orange
19	B15	Red	Orange
20	Ground	Black	Black

Block Diagram

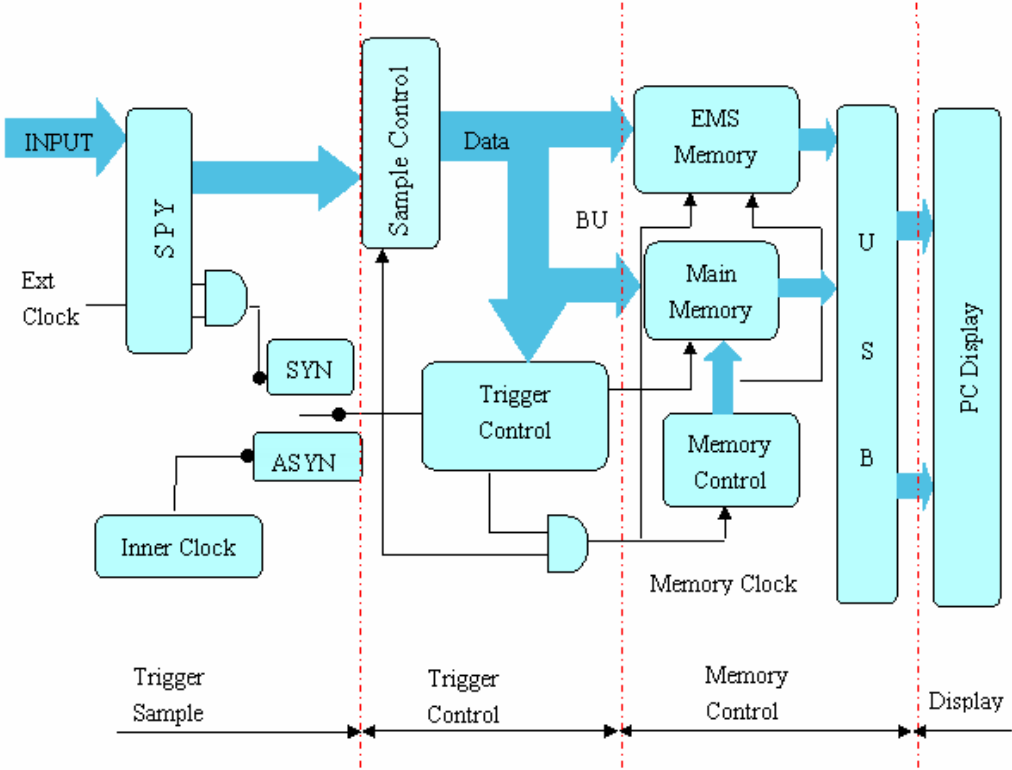

Cleaning and maintenance

Cleaning

In order to maintain the cleanliness of equipment, you need to check whether the channels are dusty or not. Please clean the out surface of the equipment follow these matters.

1. Use velvet cloth contact the surface of the equipment.
2. Pease do not use any corrosive or chemistry.

Caution: Please make sure the equipment is dry enough before going to work. Avoid mangling the equipment or hurting body because of water!

Maintenance

Don't put the equipment under the sun for a long time. Put it in wind to the best of one's abilities

Caution: In order to not mangle the equipment, you should not put it in fog, water or impregnate.