

**NuDAQ<sup>®</sup>**  
**6208/6216 Series**  
**Multi-channel Analog Output Cards**  
**User's Guide**



Recycle Paper



©Copyright 2002 ADLINK Technology Inc.

All Rights Reserved.

Manual Rev. 3.22: September 13, 2002

Part No.: 50-12201-005

The information in this document is subject to change without prior notice in order to improve reliability, design and function and does not represent a commitment on the part of the manufacturer.

In no event will the manufacturer be liable for direct, indirect, special, incidental, or consequential damages arising out of the use or inability to use the product or documentation, even if advised of the possibility of such damages.

This document contains proprietary information protected by copyright. All rights are reserved. No part of this manual may be reproduced by any mechanical, electronic, or other means in any form without prior written permission of the manufacturer.

### **Trademarks**

NuDAQ®, NuIPC®, DAQBench are registered trademarks of ADLINK Technology Inc.

Other product names mentioned herein are used for identification purposes only and may be trademarks and/or registered trademarks of their respective companies.

# Getting service from ADLINK

- Customer Satisfaction is the most important priority for ADLINK Tech Inc. If you need any help or service, please contact us.

<b>ADLINK Technology Inc.</b>			
Web Site	http://www.adlinktech.com		
Sales & Service	Service@adlinktech.com		
Technical Support	NuDAQ + USBDAQ	nudaq@adlinktech.com	
	Automation	automation@adlinktech.com	
	NuIPC	nuipc@adlinktech.com	
	NuPRO / EBC	nupro@adlinktech.com	
TEL	+886-2-82265877	FAX	+886-2-82265717
Address	9F, No. 166, Jian Yi Road, Chunggho City, Taipei, 235 Taiwan.		

- Please email or FAX us of your detailed information for a prompt, satisfactory and constant service.

<b>Detailed Company Information</b>			
Company/Organization			
Contact Person			
E-mail Address			
Address			
Country			
TEL		FAX	
Web Site			
<b>Questions</b>			
Product Model			
Environment to Use	OS: Computer Brand: M/B:                      CPU: Chipset:                BIOS: Video Card: Network Interface Card: Other:		
Detail Description			
Suggestions to ADLINK			

# Table of Contents

<b>Tables and Figures .....</b>	<b>iii</b>
<b>How to Use This Guide .....</b>	<b>iv</b>
<b>Introduction .....</b>	<b>1</b>
1.1 Features .....	2
1.2 Applications .....	2
1.3 Specifications .....	2
1.4 Supporting Software .....	5
1.4.1 Programming Library .....	5
1.4.2 PCIS-LVIEW: LabVIEW <sup>®</sup> Driver .....	6
1.4.3 PCIS-VEE: HP-VEE Driver .....	6
1.4.4 DAQBench <sup>™</sup> : ActiveX Controls .....	6
1.4.5 DASyLab <sup>™</sup> PRO .....	6
1.4.6 PCIS-DDE: DDE Server and InTouch <sup>™</sup> .....	6
1.4.7 PCIS-ISG: ISaGRAF <sup>™</sup> driver .....	7
1.4.8 PCIS-ICL: InControl <sup>™</sup> Driver .....	7
1.4.9 PCIS-OPC: OPC Server .....	7
<b>Getting Started .....</b>	<b>8</b>
2.1 What You Have .....	8
2.2 Unpacking .....	9
2.3 PCB Layout .....	10
2.4 Connector Pin Assignment .....	15
2.5 Hardware Installation Outline .....	16
2.6 Device Installation for Windows Systems .....	17
2.7 Termination Board Connection .....	17
<b>Registers.....</b>	<b>18</b>
3.1 PCI PnP Registers .....	18
3.2 I/O Address Map .....	19
3.3 Analog Output Status Register .....	20
3.4 Digital Output Register .....	20
3.5 Digital Input Register .....	20

<b>Operation Theory .....</b>	<b>21</b>
4.1 Voltage Output .....	21
4.2 Current Output .....	22
<b>C/C++ Library.....</b>	<b>23</b>
5.1 Libraries Installation .....	23
5.2 Programming Guide .....	24
5.2.1 Naming Convention .....	24
5.2.2 Data Types.....	24
5.3 _6208_Initial.....	25
5.4 _6208_Software_Reset .....	26
5.5 _6208_DA .....	27
5.6 _6208_Get_DA_Status .....	28
5.7 _6208_DI.....	29
5.8 _6208_DO.....	30
5.9 _6208_I2V_Control .....	31
<b>Utility / Calibration .....</b>	<b>32</b>
6.1 Running the 6208util.exe .....	32
6.1.1 Functional Testing.....	33
6.1.2 Calibration.....	34
6.2 Calibration of Analog Output Channel .....	35
6.2.1 What You Need.....	35
6.2.2 VR Assignment of cPCI/PCI-6208 and PCI-6216 .....	36
6.2.3 Voltage Output Calibration.....	37
6.2.4 Current Output Calibration .....	37
<b>Warranty Policy .....</b>	<b>38</b>

# Tables and Figures

## Tables

Table 1.	I/O Address Map .....	19
Table 2.	Digital Value Vs Analog output voltage .....	21
Table 3.	Current Output and Range Control .....	22
Table 4.	Data types and it range .....	24
Table 5.	VR Assignment.....	36

## Figures

Figure 1:	PCI-6208 REV: A3 Layout.....	10
Figure 2:	PCI-6208 REV: B1 Layout.....	11
Figure 3:	cPCI-6208 Layout.....	12
Figure 4:	cPCI-6208V/R Layout.....	13
Figure 5:	cPCI-R6216DB Rear I/O Adapter for cPCI-6208V/R, cPCI-6208A/R and cPCI-6216V/R .....	14
Figure 6:	cPCI-6208V(A)/R and cPCI-6216V/R Front Panel (Left to Right).....	14
Figure 7:	Pin Assignment of CN1 connector .....	15
Figure 8:	Current Output Circuits.....	22
Figure 9:	Main selection Menu .....	32
Figure 10:	Function Testing Menu Window.....	33
Figure 11:	6208V Testing Window .....	33
Figure 12:	6208 Calibration Window .....	34
Figure 13:	Channel Selection Menu .....	35
Figure 14:	Calibration Procedures Window .....	35

# How to Use This Guide

This manual is designed to help you use the 6208 series products. It describes how to modify and control various functions of the products to achieve your requirements. It is divided into six chapters:

- Chapter 1,** “**Introduction**”, gives an overview of the product features, applications, and specifications.
- Chapter 2,** “**Getting Started**”, describes how to install the 6208 series products. The layout of 6208 series products is shown, as well as the connectors’ specifications.
- Chapter 3,** “**Registers**”, describes the details of registers of the 6208 series product, the information is useful for the programmers who want to control the hardware with low-level programming.
- Chapter 4,** “**Operation Theorem**”, describes more detail concept about 6208’s functions, including analog output and range control systems.
- Chapter 5,** “**Software Library**”, describes the software libraries for programming the 6208 series cards. The software libraries for DOS and Windows 95 are provided. It assist users program and control the 6208 series cards with high-level programming languages.
- Chapter 6,** “**Utility/Calibration**”, describes how to run the utility program included in the software CD. And how to calibrate the 6208 series cards for accurate measurements and operations.



# Introduction

The 6208 series products are multi-channel analog output cards. They include the following three products:

- cPCI/PCI-6208V: 8-CH voltage output card for cPCI/PCI interface
- cPCI/PCI-6208A: 8-CH voltage and current output card for cPCI/PCI interface
- PCI-6216V: 16-CH voltage output card for PCI interface

## **cPCI-6208V, PCI-6208V:**

cPCI/PCI-6208V is a high-density analog output card with 8 identical voltage output channels. Each channel is equipped with B.B PCM56U, which is a state-of-the-art fully monotonic, digital to analog converter. This device employs ultra-stable nichrome (NiCr) thin-film resistors to provide monotonicity, low distortion, and low differential linearity error over long period of time.

## **cPCI-6216V, PCI-6216V:**

cPCI/PCI-6216V is a high-density analog voltage output card, it is a combination of the cPCI/PCI-6208V series card and an EXP-8V daughter board. The EXP-8V is an extension board, which includes 8 extra voltage output channels.

## **cPCI-6208A, PCI-6208A:**

cPCI/PCI-6208A is a high-density current source output card, it is a combination of the cPCI/PCI-6208V and an EXP-8A daughter board. The EXP-8A includes 8 precision voltage-to-current converters, which convert voltage outputs from the cPCI/PCI-6208V to current sources.

---

## 1.1 Features

- 32-bit cPCI/PCI-Bus, Plug and Play
- 16-bit high resolution voltage outputs
- Output Range:  $\pm 10\text{V}$  (14-bit resolution guarantee) for cPCI/PCI-6208V and PCI-6216V only
- Output Range: 0-20mA, 4-20mA, 5-25mA (14-bit resolution guaranteed) for cPCI/PCI-6208A only
- Differential Linearity Error: 0.001% of FSR typical
- Fast 2  $\mu\text{s}$  voltage settling time (-10V~+10V)
- On board DC-to-DC converter to provide stable power and current source for analog outputs

---

## 1.2 Applications

- Industrial Process Control
- Pressure/Temperature Transmitter
- Current Source for Testing Equipment
- Function Generator

---

## 1.3 Specifications

### ◆ Voltage Output

- **Numbers of channel:**
  - ✓ 8 channels for cPCI/PCI-6208V and cPCI/PCI-6208A
  - ✓ 16 channels for PCI-6216V
- **Converter:** B.B PCM56U or equivalent
- **Conversion type:** Monolithic multiplying
- **Resolution:** 16-bit (14-bit guarantee)
- **Voltage output ranges:**  $\pm 10\text{V}$
- **Voltage output driving capability:**  $\pm 5\text{mA}$  max.
- **Settling time:** 2 $\mu$  second (-10V to +10V)
- **Gain error:**  $\pm 0.2\%$  (max, without trimming)

- **Differential Linearity Error:**  $\pm 0.001$  % Full Scale Range
  - **Output initial status:** 0V (after RESET or POWER-ON)
  - **Data Transfer:** Programmed I/O
- ◆ **Current Output**
- **Numbers of channel:** 8 channel for cPCI/PCI-6208A
  - **Current output range:** (programmable) 0~20mA, 4~20mA, 5~25mA.
  - **Voltage to current converter:** B.B XTR110 or equivalent
  - **Settling time:** 17  $\mu$  second (from 0 to 20mA)
  - **Slew rate:** 1.3 mA /  $\mu$ s
  - **Non-linearity:**  $\pm 0.01$  % of Span
  - **Span error:** 0.3% of initial Span
  - **Output resistance:** 10x10<sup>9</sup> Ohms Typical
  - **Output initial status:** 0mA (after RESET or POWER-ON)
- ◆ **Digital I/O**
- **Channel:** 4 TTL compatible inputs and outputs
  - **Input Voltage:**
    - ✓ **Low:** Min. 0V; Max. 0.8V
    - ✓ **High:** Min. +2.0V; Max. 5.5V
  - **Input Load:**
    - ✓ **Low:** +0.8V @ -0.2mA max.
    - ✓ **High:** +2.7V @ +20mA max.
  - **Output Voltage:**
    - ✓ **Low:** Min. 0V; Max. 0.4V
    - ✓ **High:** Min. +2.4V; Max. 5.5V
  - **Driving Capacity:**
    - ✓ **Low:** Max. +0.5V at 8.0mA (Sink)
    - ✓ **High:** Min. 2.7V at 0.4mA (Source)

- ◆ **General Specifications**
  - **Operating temperature:** 0° ~ 50°C
  - **Storage temperature:** -20° ~ 80°C
  - **Humidity:** 5~95% non-condensing
  - **Connector:** 37-pin D-sub connector (female)
  - **Bus interface:** 32-bit slave PCI bus
- ◆ **Power consumption:**
  - **PCI-6208V:**
    - ✓ +5VDC @ 580mA typical
    - ✓ +12VDC @ 70mA typical
  - **PCI-6208A:**
    - ✓ +5VDC @ 670mA typical
    - ✓ +12VDC @ 90mA typical or +12VDC @ 380mA (when all current output channel is 20mA)
  - **PCI-6216V:**
    - ✓ +5VDC @ 1.20 typical
    - ✓ +12VDC @ 110mA typical
  - **cPCI-6208V:**
    - ✓ +5VDC @ 560mA typical
    - ✓ +12VDC @ 70mA typical
  - **cPCI-6208A:**
    - ✓ +5VDC @ 650mA typical
    - ✓ +12VDC @ 90mA typical or +12VDC @ 370mA (when all current output channel is 25mA)
- ◆ **PCB Dimension:**
  - **Half-sized**
    - ✓ PCI series: 175 mm x 105 mm
    - ✓ cPCI series: 160 mm x 100 mm

---

## 1.4 Supporting Software

ADLINK provides versatile software drivers and packages for users' different approach to building a system. ADLINK not only provides programming libraries such as DLL for most Windows based systems, but also provide drivers for many software package such as LabVIEW®, HP VEETM, DASyLab™, InTouch™, InControl™, ISaGRAFT™, and so on.

All software options are included in the ADLINK CD. Non-free software drivers are protected with licensing codes. Without the software code, you can install and run the demo version for two hours for trial/demonstration purposes. Please contact ADLINK dealers to purchase the formal license.

### 1.4.1 Programming Library

For customers who are writing their own programs, we provide function libraries for many different operating systems, including:

- **DOS Library:** Borland C/C++ and Microsoft C++. Functional descriptions are included in this user's guide.
- **Windows 95 DLL:** For VB, VC++, Delphi, and BC5. Functional descriptions are included in this user's guide.
- **PCIS-DASK:** Include device drivers and DLL for Windows 98, Windows NT and Windows 2000. DLL is binary compatible across Windows 98, Windows NT and Windows 2000. That means all applications developed with PCIS-DASK are compatible across Windows 98, Windows NT and Windows 2000. The developing environment can be VB, VC++, Delphi, BC5, or any Windows programming language that allows calls to a DLL. The user's guide and function reference manual of PCIS-DASK are in the CD. Please refer the PDF manual files under \\Manual\_PDF\Software\PCIS-DASK
- **PCIS-DASK/X:** Includes device drivers and shared libraries for **Linux**. The developing environment can be Gnu C/C++ or any programming language that allows linking to a shared library. The user's guide and functional reference manual for the PCIS-DASK/X are in the CD. (Manual\_PDF\Software\PCIS-DASK-X.)

The above software drivers are shipped with the board. Please refer to the "Software Installation Guide" for installation procedures.

### **1.4.2 PCIS-LVIEW: LabVIEW® Driver**

PCIS-LVIEW contains the VIs, which are used to interface with NI's PCIS-LVIEW contains the VIs, which is used to interface with NI's LabVIEW® software package. The PCIS-LVIEW supports Windows 95/98/NT/2000. The LabVIEW® drivers is shipped free with the board. You can install and use them without a license. For more information about PCIS-LVIEW, please refer to the user's guide in the CD. (\\Manual\_PDF\Software\PCIS-LVIEW).

### **1.4.3 PCIS-VEE: HP-VEE Driver**

The PCIS-VEE includes user objects, which are used to interface with the HP-VEE software package. PCIS-VEE supports Windows 95/98/NT. The HP-VEE drivers are shipped free with the board. You can install and use them without a license. For more information about PCIS-VEE, please refer to the user's guide in the CD. (\\Manual\_PDF\Software\PCIS-VEE).

### **1.4.4 DAQBench™: ActiveX Controls**

We suggest users who are familiar with ActiveX controls and VB/VC++ programming use the DAQBench™ ActiveX Control components library for developing applications. The DAQBench™ is designed under Windows NT/98. For more information about DAQBench, please refer to the user's guide in the CD. (\\Manual\_PDF\Software\DAQBench\DAQBench Manual.PDF)

### **1.4.5 DASyLab™ PRO**

DASyLab™ is an easy-to-use software package, which provides easy setup instrument functions such as FFT analysis. Please contact ADLINK to purchase a copy of DASyLab™ PRO, which include DASyLab™ and ADLINK hardware drivers.

### **1.4.6 PCIS-DDE: DDE Server and InTouch™**

DDE stands for Dynamic Data Exchange. The PCIS-DDE includes the PCI cards' DDE server. The PCIS-DDE server is free and is included in the ADLINK CD. The DDE server can be used in conjunction with any DDE client under Windows 98/NT/2000.

#### **1.4.7 PCIS-ISG: ISaGRAF™ driver**

The ISaGRAF Workbench is an IEC1131-3 SoftPLC control development environment. The PCIS-ISG includes ADLINK product drivers for ISaGRAF under Windows NT environment. The PCIS-ISG is included in the ADLINK CD. It is not free. Please contact ADLINK dealers or ADLINK to purchase the license.

#### **1.4.8 PCIS-ICL: InControl™ Driver**

PCIS-ICL is the InControl drivers that support Windows NT. The PCIS-ICL is included in the ADLINK CD. It needs license.

#### **1.4.9 PCIS-OPC: OPC Server**

PCIS-OPC is an OPC server, which can be used to link with other OPC clients. There are many software packages on the market that can provide the OPC clients. The PCIS-OPC supports Windows 98, NT, and 2000. It is not free. Please contact ADLINK dealers or ADLINK to purchase the license.

# 2

## Getting Started

This chapter describes how to install and setup the cPCI/PCI-6208. The contents in the package and unpacking information that you should be aware of are outlined first.

---

### 2.1 What You Have

In addition to the User's Manual, the package should include the following items:

- 6208 Series Card
- ADLINK CD
- Software Installation Guide

If any of these items are missing or damaged, contact ADLINK or the dealer from whom you purchased the product. Save the shipping materials and carton in case you want to ship or store the product in the future.



---

## 2.2 Unpacking

The 6208 card contains electro-static sensitive components that can be easily be damaged by static electricity.

Therefore, the card should be handled on a grounded anti-static mat. The operator should be wearing an anti-static wristband, grounded at the same point as the anti-static mat.

Inspect the card module carton for obvious damages. Shipping and handling may cause damage to your module. Be sure there are no shipping and handling damages on the modules carton before continuing.

After opening the card module carton, extract the system module and place it only on a grounded anti-static surface with component side up.

Again, inspect the module for damages. Press down on all the socketed IC's to make sure that they are properly seated. Do this only with the module place on a firm flat surface.

---

**Note:** DO NOT ATTEMPT TO INSTALL A DAMAGED BOARD IN THE COMPUTER.

---

**You are now ready to install your card.**

---

## 2.3 PCB Layout

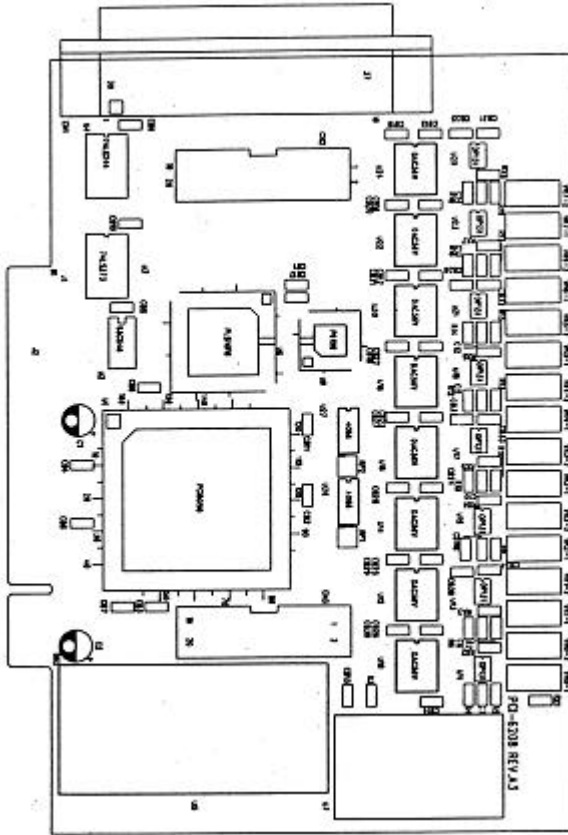

Figure 1: PCI-6208 REV: A3 Layout

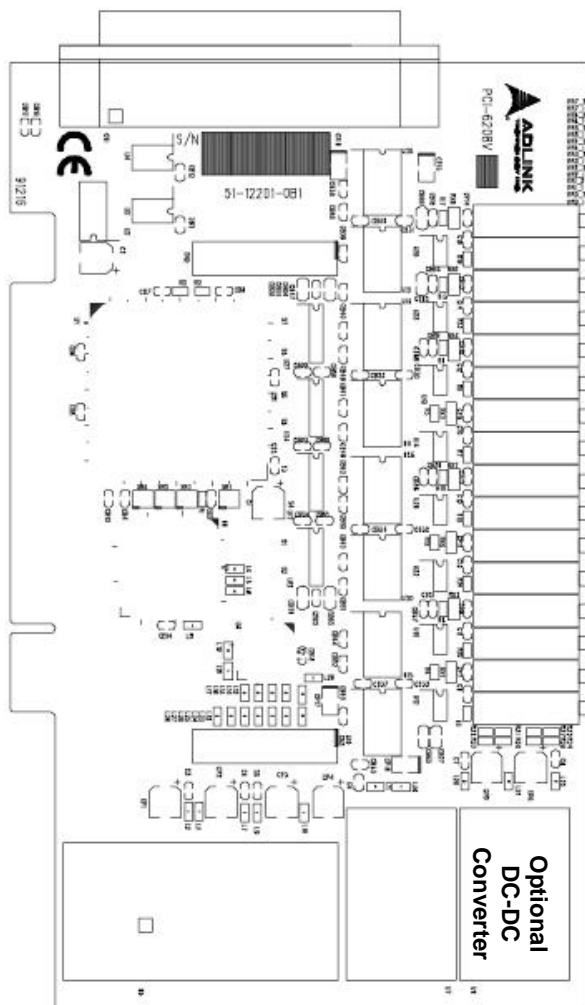

Figure 2: PCI-6208 REV: B1 Layout

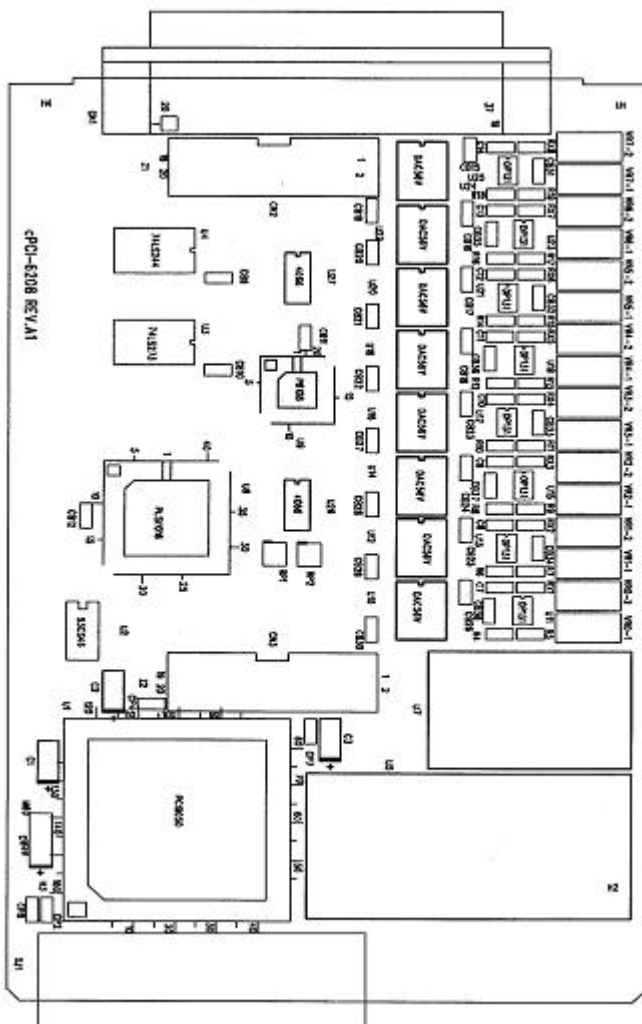

Figure 3: cPCI-6208 Layout

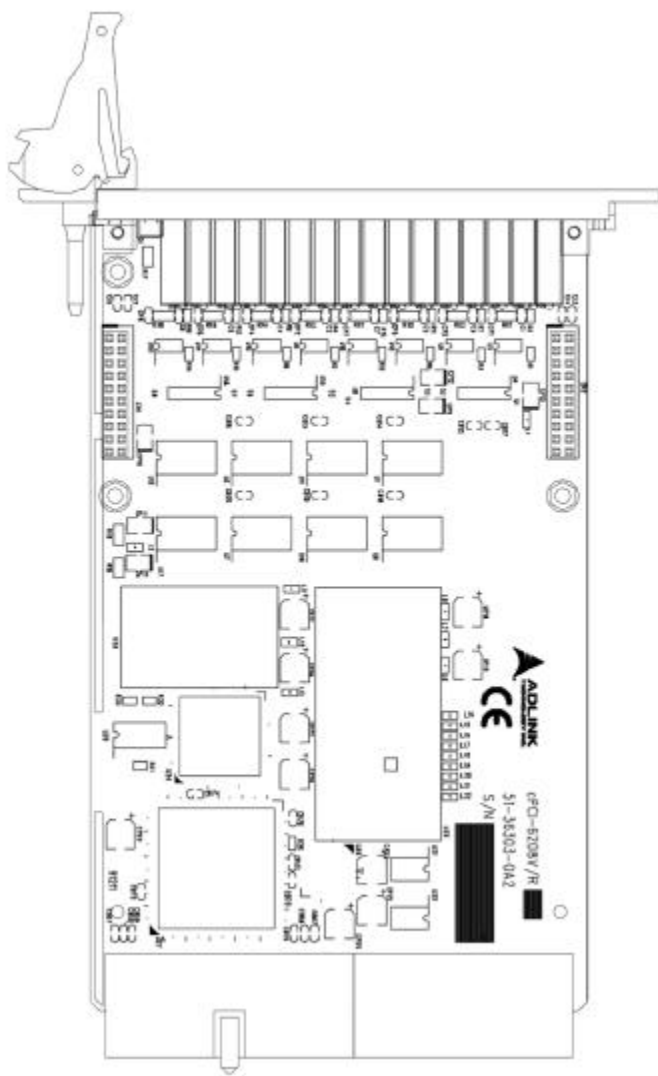

Figure 4: cPCI-6208V/R Layout

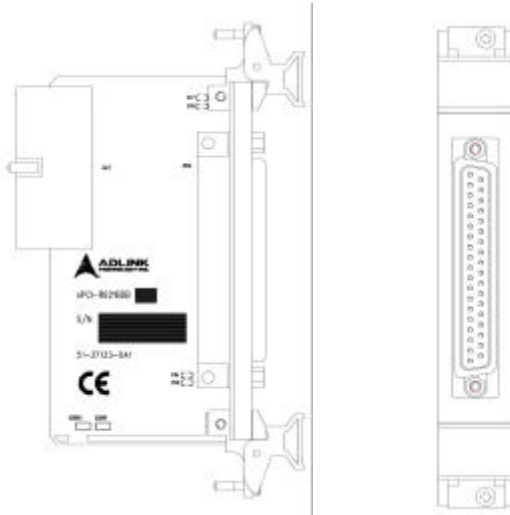

Figure 5: cPCI-R6216DB Rear I/O Adapter for cPCI-6208V/R, cPCI-6208A/R and cPCI-6216V/R

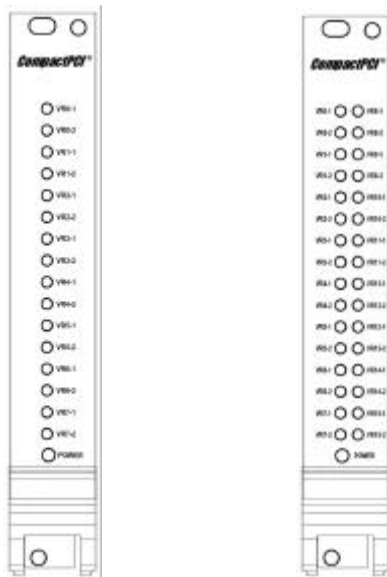

Figure 6: cPCI-6208V(A)/R and cPCI-6216V/R Front Panel (Left to Right)

---

## 2.4 Connector Pin Assignment

The pin assignment of the 6208 series card is shown in Figure 2.2

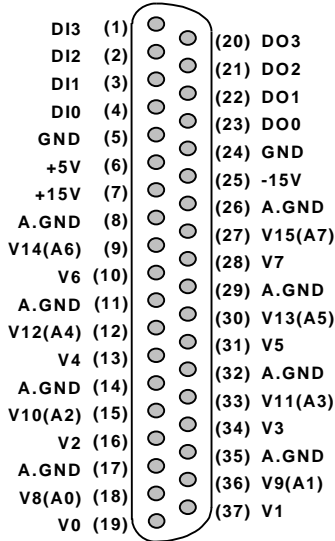

Figure 7: Pin Assignment of CN1 connector

The analog output pin are specified as **Vn** or **An**, where

**Vn:** Means the voltage output of channel number *n*.

For cPCI/PCI-6208V, *n*=0~7

For PCI-6216V, *n*=0~15

**An:** Means the current output of channel number *n*

For cPCI/PCI-6208A only, *n*=0~7

The digital input and output pin names are specified as **DI*n*** and **DO*n*** respectively, where *n*=0~3.

---

## 2.5 Hardware Installation Outline

### Hardware configuration

The PCI cards (or CompactPCI cards) are equipped with plug and play PCI controllers, it can request base addresses and interrupts according to the PCI standard. The system BIOS will assign the system resources based on the PCI cards' configuration registers and system parameters (which are set by the system BIOS). Interrupt assignment and memory usage (I/O port locations) can only be assigned by the system BIOS. These system resource assignments are done on a board-by-board basis. It is not suggested to assign the system resource by any other methods.

### PCI slot selection

The PCI card can be inserted into any PCI slot without any configuration of the system resources. The CompactPCI card can also be inserted into any CompactPCI I/O slot.

### Installation Procedures

1. Turn off your computer
2. Turn off all accessories (printer, modem, monitor, etc.) connected to your computer.
3. Remove the cover from your computer.
4. Setup jumpers on the PCI or CompactPCI card.
5. Select a 32-bit PCI slot. PCI slot are shorter than ISA or EISA slots, and are usually white or ivory.
6. Before handling the PCI cards, discharge any static buildup on your body by touching the metal case of the computer. Hold the edge and do not touch the components.
7. Position the board into the PCI slot you selected.
8. Secure the card in place at the rear panel of the system.



---

## 2.6 Device Installation for Windows Systems

Once Windows 95/98/2000 has started, the Plug and Play functions of the Windows system will find and locate the new NuDAQ/NuIPC card. If this is the first time a NuDAQ/NuIPC card is installed in your Windows system, you will be prompted to input the device information source. Please refer to the “**Software Installation Guide**” for installation procedures of the device drivers.

---

## 2.7 Termination Board Connection

The 6208 series boards are equipped with a DB-37 connector. The available termination boards include:

**ACLD-9137:** A general purposed 37-pin screw terminal. The ACLD-9137 is designed with a male DB-37 connector, which is used to directly attach to the PCI-6208.

**ACLD-9188:** A general purposed 37-pin screw terminal, which is equipped with heavy-duty screw terminal

**DIN-37D:** A general purposed 37-pin screw terminal with a DIN-socket. DIN-37D is shipped with a 37-pin cable

# 3

## Registers

The detailed descriptions of the registers format are specified in this chapter. This information is quite useful for the programmers who wish to handle the card by low-level programming. However, we suggest user have to understand more about the PCI interface then start any low-level programming. In addition, the contents of this chapter can help users understand how to use software driver to manipulate this card.

---

### 3.1 PCI PnP Registers

This PCI card functions as a 32-bit PCI target device to any master on the PCI bus. There are three types of registers: PCI Configuration Registers (PCR), Local Configuration Registers (LCR) and PCI-6208 registers.

The PCR, which is PCI-bus specifications compliant, is initialized and controlled by the plug & play (PnP) PCI BIOS. Users may obtain more information on the PCI BIOS specification to better understand the operation of the PCR. Please contact PCISIG to acquire the specifications of the PCI interface.

The PCI bus controller PCI-9050 is provided by PLX technology Inc. ([www.plxtech.com](http://www.plxtech.com)). For more information about the LCR, please visit PLX technology's web site to download relative information. It is not necessary for users to fully understand the details of the LCR if the software library provided is used. The PCI PnP BIOS assigns the base address of the LCR. The assigned address is located at an offset of 14h from the PCR.

The PCI-6208 registers are discussed in the next section. The base address, which is also assigned by the PCI PnP BIOS, is located at an offset of 18h from the PCR. Therefore, users can read the address 18h from the PCR to obtain its base address by using the BIOS function call. Do not attempt to modify the base address and interrupt that have been assigned by the PCI PnP BIOS, it may cause resource conflicts with your system.

---

## 3.2 I/O Address Map

Depending on which card is used, either the cPCI/PCI-6208V or PCI-6216V, there are 8 or 16 voltage output channels respectively. For the cPCI/PCI-6208A, there are 8 voltage and current output channels; the voltage output controls the current source. The programming methods of all analog output channels are identical. For the three different models of the analog output cPCI/PCI cards, the programming methods are compatible.

The 6208 registers are all 16 bits. Users can access these registers with 16-bit I/O instructions. The following table shows the address of every analog output port relative to the base address. Note that the base address is assigned by the PCI BIOS. The current output control for the cPCI/PCI-6208A is described in Section 3.4.

Offset Address	CPCI/PCI-6208V	PCI-6216V	cPCI/PCI-6208A
0x00	V0	V0	V0 / A0
0x02	V1	V1	V1 / A1
0x04	V2	V2	V2 / A2
0x06	V3	V3	V3 / A3
0x08	V4	V4	V4 / A4
0x0A	V5	V5	V5 / A5
0x0C	V6	V6	V6 / A6
0x0E	V7	V7	V7 / A7
0x10	--	V8	--
0x12	--	V9	--
0x14	--	V10	--
0x16	--	V11	--
0x18	--	V12	--
0x1A	--	V13	--
0x1C	--	V14	--
0x1E	--	V15	--

Table 1. I/O Address Map

---

### 3.3 Analog Output Status Register

The DAC uses a series bus architecture hence it will take time for digital value to be sent out. The data transfer rate for every DA data write takes  $2.2\mu\text{s}$ , therefore the software driver must wait  $2.2\mu\text{s}$  before sending any other data to any analog output port. While the DA value is sending, the Data\_Send bit is 'H'. The software driver should check this bit before writing any data to the output port. This register is read only.

Offset Address	D16~D1	D0
0x00	X	Data_Send

---

### 3.4 Digital Output Register

D0~D3 is the digital output signal written to the output channels. D4~D7 are don't cares.

Offset Address	D7	D6	D5	D4	D3	D2	D1	D0
0x40	X	X	X	X	DO3	DO2	DO1	DO0

---

### 3.5 Digital Input Register

D4~D7 is digital input signal from CN1.

D0~D3 is read back signal from digital output channel.

Offset Address	D7	D6	D5	D4	D3	D2	D1	D0
0x40	DI3	DI2	DI1	DI0	DO3	DO2	DO1	DO0

# 4

## Operation Theory

In this chapter, the operation theory of the 6208 series cards is described. Before programming or applying the 6208 series cards to your applications, please go through this chapter to understand the features of the functions.

### 4.1 Voltage Output

The DA converter used in the cPCI/PCI-6208 is a Burr-Brown PCM-56U. The DAC has a 16-bit resolution with bi-polar output. The voltage output range is +/-10V. Therefore, the data registers are all 16-bits sign values. The digital value ranges from -32768 (0X8000) to +32767 (0x7FFF) corresponding to -10 Volt to +10 Volt. Table 2 shows the relation between the digital value and the analog output voltage.

Digital Value	HEX value	Output Voltage
32767	0x7FFF	+9.99969V
16384	0x4000	+5.00000V
8192	0x2000	+2.50000V
1	0x0001	0.00031V
0	0x0000	0.00000V
-1	0xFFFF	-0.00031V
-8192	0xE000	-2.50000V
-16384	0xC000	-5.00000V
-32767	0x8001	-9.99969V
-32768	0x8000	-10.00000V

Table 2. Digital Value Vs Analog output voltage

## 4.2 Current Output

The precision voltage-to-current converter XTR110 implements the current output. The current output channel  $n$  ( $A_n$ ) is control by the voltage of channel  $n$  ( $V_n$ ). The block diagram of the current output channels is shown in Fig 5.

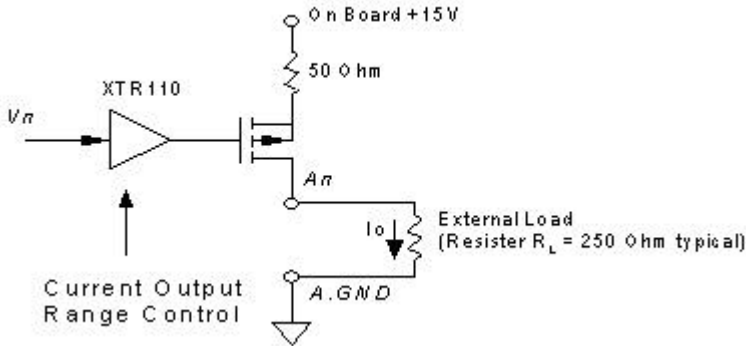

Figure 8: Current Output Circuits

The cPCI/PCI-6208A provides an on board +15V power supply. Each current output channel is a current source, which is controlled by the voltage of the corresponding channel. For example, voltage output channel 3 control the current source of channel 3. The output current range is programmable. All 8 current channels on the cPCI/PCI-6208A are controlled by one control register. The control voltage range is always unipolar 0~10V. There are three kinds of output current ranges. Refer to the following table and Section 5.2.8 for programming information.

Mode	Input Voltage Range	Output Current Range
1	0~10V	0~20 mA
2	0~10V	4~20 mA
3	0~10V	5~25 mA

Table 3. Current Output and Range Control

**Caution:** The Current Output Module accepts only POSITIVE control voltage; applying negative voltage may permanently damage the module or your device.

# 5

## C\C++ Library

This chapter describes the software libraries for operating this card. Only the functions in the DOS library and Windows 95 DLL are described. Please refer to the PCIS-DASK function reference manual, which is included in the ADLINK CD, for descriptions of Windows 98/NT/2000 DLL functions.

The function prototypes and useful constants are defined in the header files located in LIB (DOS) and INCLUDE (Windows 95) directories. For Windows 95 DLL, the developing environment can be Visual Basic 4.0 or above, Visual C/C++ 4.0 or above, Borland C++ 5.0 or above, Borland Delphi 2.x (32-bit) or above, or any Windows programming language that allows calls to a DLL.

---

### 5.1 Libraries Installation

Please refer to the “**Software Installation Guide**” for information regarding how to install the software libraries for DOS, Windows 95 DLL, or PCIS-DASK for Windows 98/NT/2000.

The device drivers and DLL functions for Windows 98/NT/2000 are included in the PCIS-DASK. Please refer to the PCIS-DASK user’s guide and function reference, which is included in the ADLINK CD, for programming information.

---

## 5.2 Programming Guide

### 5.2.1 Naming Convention

The functions of the NuDAQ PCI or NuIPC CompactPCI card software drivers uses full-names to represent the functions' real meaning. The naming convention rules are:

**In DOS Environment:**

`_{hardware_model}_{action_name}`. e.g. `_6208_Initial()`.

All functions in the PCI-6208 driver uses 6208 as {hardware\_model}

In order to recognize the differences between DOS library and Windows 95 library, a capital "W" is placed at the start of each function name for Windows 95 DLL drivers, e.g. `w_9112_Initial()`.

### 5.2.2 Data Types

We have defined some data type in `Pci_6208.h` (DOS) and `Acl_pci.h` (Windows 95). These data types are used by NuDAQ Cards' library. We suggest you to use these data types in your application programs. The following table shows the data type names and their range.

Type Name	Description	Range
U8	8-bit ASCII character	0 to 255
I16	16-bit signed integer	-32768 to 32767
U16	16-bit unsigned integer	0 to 65535
I32	32-bit signed integer	-2147483648 to 2147483647
U32	32-bit single-precision floating-point	0 to 4294967295
F32	32-bit single-precision floating-point	-3.402823E38 to 3.402823E38
F64	64-bit double-precision floating-point	-1.797683134862315E308 to 1.797683134862315E309
Boolean	Boolean logic value	TRUE, FALSE

Table 4. Data types and it range



---

## 5.3 `_6208_Initial`

### **@ Description**

This function is used to initialize the 6208 series cards. You must call this function to initialize all 6208 series cards plugged into your system first, before calls to other function to perform operations on the cards can proceed.

### **@ Syntax**

#### **C/C++ (DOS)**

```
U16 _6208_Initial (U16 *existCards, PCI_INFO
                 *pciInfo)
```

#### **C/C++ (Windows 95)**

```
U16 W_6208_Initial (U16 *existCards, PCI_INFO
                  *pciInfo)
```

#### **Visual Basic (Windows 95)**

```
W_6208_Initial (existCards As Integer, pciInfo
               As PCI_INFO) As Integer
```

### **@ Argument**

`existCards`: number of 6208 cards inserted  
`pciinfo`: relative information of the 6208 cards

### **@ Return Code**

```
ERR_NoError  
ERR_BoardNoInit  
ERR_PCIBiosNotExist
```

---

## 5.4 \_6208\_Software\_Reset

### **@ Description**

This function is used to reset the I/O ports configuration. Note that this function will not re-start the PCI bus and all the hardware settings won't be changed either.

### **@ Syntax**

#### **C/C++ (DOS)**

```
void _6208_Software_Reset (U16 cardNo)
```

#### **C/C++ (Windows 95)**

```
void W_6208_Software_Reset (U16 cardNo)
```

#### **Visual Basic (Windows 95)**

```
W_6208_Software_Reset (ByVal cardNo As Integer)
```

### **@ Argument**

cardNo: The card number of the 6208 card initialized. (The first card in the most significant PCI slot is assign cardNo = 0).

### **@ Return Code**

```
ERR_NoError
```

---

## 5.5 `_6208_DA`

### **@ Description**

This function is used to write data to the D/A converters. There are 8 or 16 Digital-to-Analog conversion channels depending on which card is used. The resolution of each channel is 16 bits with sign; i.e. the digital value range from -32768 (0x8000) to +32767 (0x7FFF).

### **@ Syntax**

#### **C/C++ (DOS)**

```
U16 _6208_DA (U16 cardNo, U16 chn, I16 DADData)
```

#### **C/C++ (Windows 95)**

```
U16 W_6208_DA (U16 cardNo, U16 chn, I16 DADData)
```

#### **Visual Basic (Windows 95)**

```
W_6208_DA (ByVal cardNo As Integer, ByVal chn As Integer, ByVal DADData As Integer) As Integer
```

### **@ Argument**

`cardNo`: The card number of the 6208 card initialized. (The first card in the most significant PCI slot is assign `cardNo = 0`).

`Chn`: D/A channel number

`DADData`: D/A converted value

### **@ Return Code**

```
ERR_NoError
```

---

## 5.6 `_6208_Get_DA_Status`

### **@ Description**

This function is used to check the DA data sending status. Because the data transfer time for every DA data takes 2.2  $\mu\text{s}$ , the software driver must hold for 2.2 $\mu\text{s}$  before sending more data to any of the analog output ports. This function should be called before writing any data to the output port. While the DA value is sending, the returned value is "1", otherwise the returned value is "0".

### **@ Syntax**

#### **C/C++ (DOS)**

```
U16 _6208_Get_DA_Status (U16 cardNo)
```

#### **C/C++ (Windows 95)**

```
U16 W_6208_Get_DA_Status (U16 cardNo)
```

#### **Visual Basic (Windows 95)**

```
W_6208_Get_DA_Status (ByVal cardNo As Integer)  
As Integer
```

### **@ Argument**

cardNo: The card number of the 6208 card initialized. (The first card in the most significant PCI slot is assign cardNo = 0).

### **@ Return Code**

0 (low): no DA value is sending

1 (high): the DA value is sending

---

## 5.7 `_6208_DI`

### **@ Description**

This function is used to read data from the digital input ports. There are 4 digital input channels on the 6208 series cards. The retrieved value is stored in `DIData`. However the returned value needs to be further process by including the following code in your program: **`DIData = (DIData & 0xF0) >> 4`**

### **@ Syntax**

#### **C/C++ (DOS)**

```
U16 _6208_DI (U16 cardNo, U16 *DIData)
```

#### **C/C++ (Windows 95)**

```
U16 W_6208_DI (U16 cardNo, U16 *DIData)
```

#### **Visual Basic (Windows 95)**

```
W_6208_DI (ByVal cardNo As Integer, DIData As Integer) As Integer
```

### **@ Argument**

`cardNo`: The card number of the 6208 card initialized. (The first card in the most significant PCI slot is assign `cardNo = 0`).

`DIData`: the value read from the digital input port, please refer to the above descriptive paragraph to obtain the correct DI data

### **@ Return Code**

```
ERR_NoError
```

---

## 5.8 `_6208_DO`

### **@ Description**

This function is used to write data to digital output ports. There are 4 digital output channels on 6208 series card, i.e. the output value ranges from 0 to 15.

### **@ Syntax**

#### **C/C++ (DOS)**

```
U16 _6208_DO (U16 cardNo, U16 DOData)
```

#### **C/C++ (Windows 95)**

```
U16 W_6208_DO (U16 cardNo, U16 DOData)
```

#### **Visual Basic (Windows 95)**

```
W_6208_DO (ByVal cardNo As Integer, ByVal  
DOData As Integer) As Integer
```

### **@ Argument**

`cardNo`: The card number of the 6208 card initialized. (The first card in the most significant PCI slot is assign `cardNo = 0`).

`DOData`: the value written to the digital output port

### **@ Return Code**

```
ERR_NoError
```

---

## 5.9 \_6208\_I2V\_Control

### **@ Description**

This function is used to set the cPCI/PCI-6208A voltage-to-current mode control. There are three range modes for the cPCI/PCI-6208A. Please refer to section 4.2 for description of voltage to current conversion.

### **@ Syntax**

#### **C/C++ (DOS)**

```
U16 _6208_I2V_Control (U16 cardNo, U16 ctrl)
```

#### **C/C++ (Windows 95)**

```
U16 W_6208_DO (U16 cardNo, U16 DOData)
```

#### **Visual Basic (Windows 95)**

```
W_6208_I2V_Control (ByVal cardNo As Integer,  
ByVal ctrl As Integer) As Integer
```

### **@ Argument**

cardNo: The card number of the 6208 card initialized. (The first card in the most significant PCI slot is assign cardNo = 0).

ctrl: the voltage-to-current mode, the valid modes are shown in table 3 of Operation theory. The constants are defined in Pci\_6208.h (DOS) and Acl\_pci.h (Windows 95).

### **@ Return Code**

```
ERR_NoError
```

# 6

## Utility / Calibration

The software CD provides a utility program, 6208util.exe, and is intended for calibration and functional testing. The utility is a menu-driven design and operates under the DOS environment. The text messages give operating guidance, with graphics to indicate correct hardware configuration and location. The utility is described in the following sections.

### 6.1 Running the 6208util.exe

After finishing the DOS installation, you can execute the utility by typing the following command. (Assuming your utility is located in \ADLINK\DOS\6208\Util directory), the following command should be entered at the DOS prompt.

```
C> cd \ADLINK\DOS\6208\Util
```

```
C> 6208UTIL
```

The following diagram will be displayed on your screen. The message at the bottom of each window guides you through the selected item.

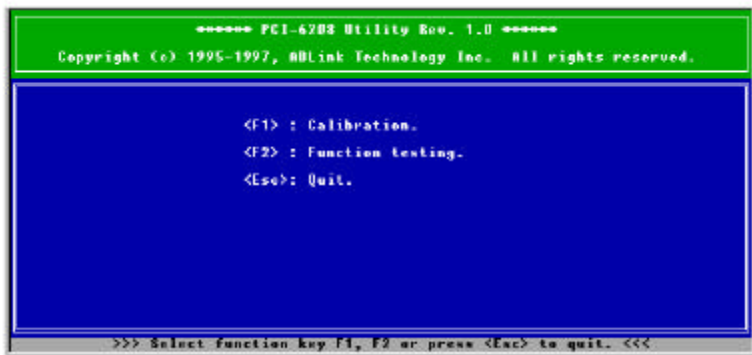

Figure 9: Main selection Menu



## 6.1.1 Functional Testing

This function is used to test the D/A functions of the cPCI/PCI-6208V /6208A /6216V.

When you choose one of the testing functions from the functions menu, a channel selection menu is displayed on the screen. Move the cursor and press <Enter> to select the channel you want to test. After you have selected a channel from the channel selection menu, a testing window appears. Figures below are the function testing menu window.

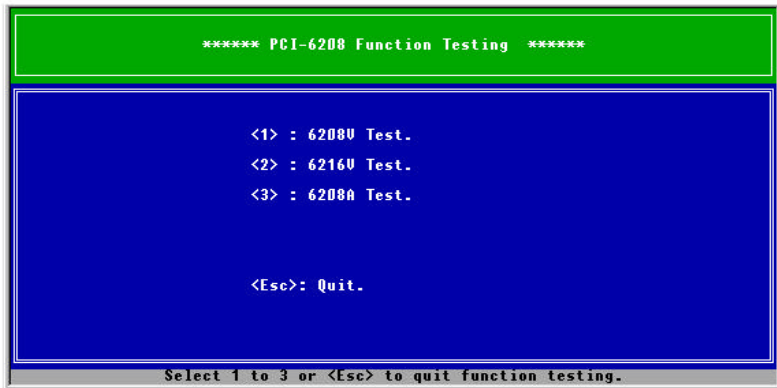

Figure 10: Function Testing Menu Window

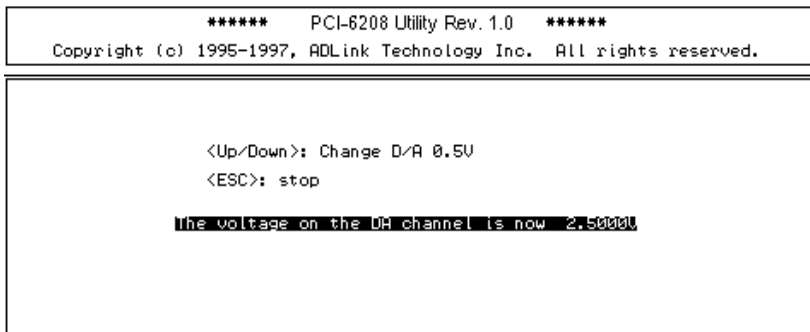

Figure 11: 6208V Testing Window

## 6.1.2 Calibration

This function guides you through on how to calibrate the 6208 series card. The calibration program can serve as a useful test for the 6208 series D/A functions and can aid in troubleshooting if problems arise.

---

**Note:** For an environment with frequent fluctuation in temperature and vibration, a 3 months re-calibration interval is recommended. For laboratory conditions, 6 months to 1 year is acceptable

---

When you choose the calibration function from the main menu list, a calibration sub-menu is displayed on the screen. After selecting a calibration item from the list of options, a calibration procedure window will appear. The instructions will guide you through the calibration process step by step.

If you select 1, the following figure displays on the screen:

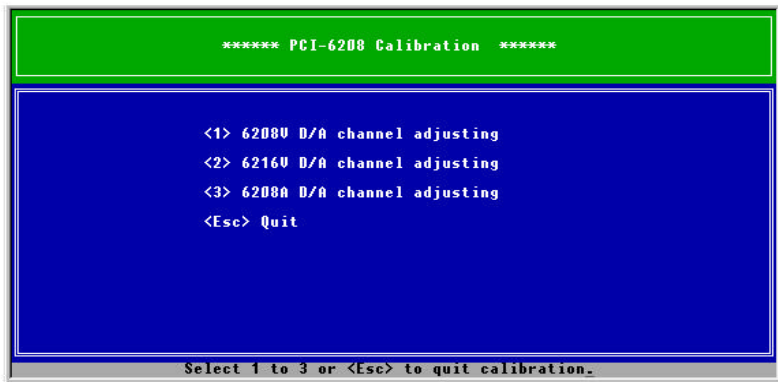
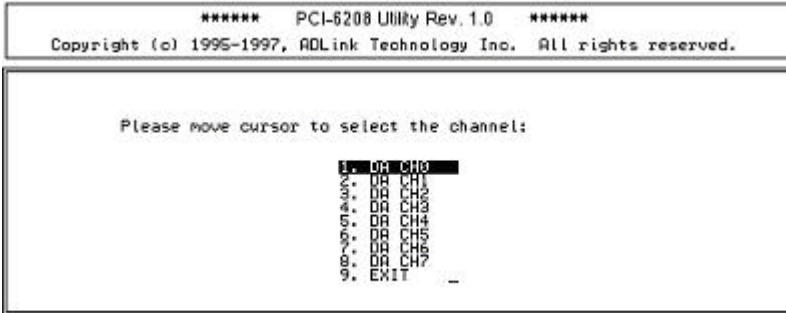

Figure 12: 6208 Calibration Window



Use <Up/Down> to select a DA Channel or 'g' to exit.

Figure 13: Channel Selection Menu

After you have selected a channel from the channel selection menu, a calibration procedures window appears. The figure below outlines the calibration procedure for the 6208V.

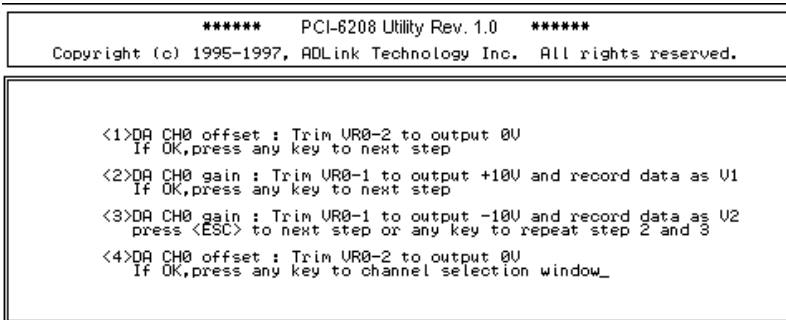

Figure 14: Calibration Procedures Window

## 6.2 Calibration of Analog Output Channel

### 6.2.1 What You Need

Before calibrating your 6208 series card, you should prepare a 6 1/2 digital multi-meter for measuring voltage signals.

## 6.2.2 VR Assignment of cPCI/PCI-6208 and PCI-6216

There are either 8 or 16 voltage output channels depending on which model of the card is used. For each channel, two VRs are used to adjust for the range and offset of the output voltage. The following table shows the assignment and function of each VR. You can find these designators on the PCB.

VR of PCI6208V or PCI6216V	Function	VR of PCI6216V	Function
VR0-1	Ch #0 full range	VR8-1	Ch #8 full range
VR0-2	Ch #0 offset	VR8-2	Ch #8 offset
VR1-1	Ch #1 full range	VR9-1	Ch #9 full range
VR1-2	Ch #1 offset	VR9-2	Ch #9 offset
VR2-1	Ch #2 full range	VR10-1	Ch #10 full range
VR2-2	Ch #2 offset	VR10-2	Ch #10 offset
VR3-1	Ch #3 full range	VR11-1	Ch #11 full range
VR3-2	Ch #3 offset	VR11-2	Ch #11 offset
VR4-1	Ch #4 full range	VR12-1	Ch #12 full range
VR4-2	Ch #4 offset	VR12-2	Ch #12 offset
VR5-1	Ch #5 full range	VR13-1	Ch #13 full range
VR5-2	Ch #5 offset	VR13-2	Ch #13 offset
VR6-1	Ch #6 full range	VR14-1	Ch #14 full range
VR6-2	Ch #6 offset	VR14-2	Ch #14 offset
VR7-1	Ch #7 full range	VR15-1	Ch #15 full range
VR7-2	Ch #7 offset	VR15-2	Ch #15 offset

Table 5. VR Assignment

---

**Note:** For PCI-6208V/6216V (REV: B1 or later), the designator of VRs are changed to VR<sub>m</sub>-<sub>n</sub>, where m = 0 ~ 15 and n = 1 or 2. Example VR6-2 on PCI-6208V/6216V REV: A3 will be changed to VR6\_2 on REV: B1 or later.

---

### 6.2.3 Voltage Output Calibration

Because there is an internal reference voltage for each DA channel, the calibration process for each channel is independent. The following procedure, VR<sub>n-1</sub> and VR<sub>n-2</sub> are used to represent the full range and offset of the nth channels. The following is the calibration procedure for the DA output.

- Step 1.** Connect the n-th DA output (V<sub>n</sub>) to DVM (+) of the digital multi-meter. Connect the AGND signal to DVM (-).
- Step 2.** Send the digital value '0' to the DA. Roughly adjust the offset (trim VR n-2) until the DVM value equals zero.
- Step 3.** Send the digital value '-32767' to the DA. Adjust VR<sub>n-2</sub> until the DVM value equals to -10V.
- Step 4.** Send the digital value '0' to the DA again. Precisely adjust the offset (trim VR n-2) until the DVM value equals zero.
- Step 5.** Repeat Steps 2-4 until the accuracy is within the application's specifications.

### 6.2.4 Current Output Calibration

The current output calibration is only available to the cPCI/PCI-6208A. As the current output channels are controlled by its corresponding voltage output channels, VR n-1 and VR n-2 are also used to calibrate the n-th current output channel.

- Step 1.** Connect the n-th current output (A<sub>n</sub>) to the DVM (A+) of the digital multi-meter. Connect both junctions of the current load (typical 250Ω) to the DVM (A-) and ground (AGND) respectively.
- Step 2.** Select the current range with the provided software program. Example: set the current range to 4~20 mA.
- Step 3.** Send the digital value '0' to the DA. Adjust the offset (trim VR<sub>n-2</sub>) until the current value equals the minimum value of the current range. Example, adjust to 4mA if the current range is 4~20mA.
- Step 4.** Send the digital value '32767' to the DA. Adjust for the full range (trim VR n-1) until the current value equals the maximum value of the full range. Example, adjust to 20 mA if the current range is 4~20mA.
- Step 5.** Repeat step 3 and step 4 until the accuracy is within the application's specifications.

# Warranty Policy

Thank you for choosing ADLINK. To understand your rights and enjoy all the after-sales services we offer, please read the following carefully.

1. Before using ADLINK's products, please read the user manual and follow the instructions exactly. When sending in damaged products for repair, please attach an RMA application form.
2. All ADLINK products come with a two-year guarantee, free of repair charge.
  - The warranty period starts from the product's shipment date from ADLINK's factory
  - Peripherals and third-party products not manufactured by ADLINK will be covered by the original manufacturers' warranty
  - End users requiring maintenance services should contact their local dealers. Local warranty conditions will depend on the local dealers
3. Our repair service does not cover two-year guarantee while damages are caused by the following:
  - a. Damage caused by not following instructions on user menus.
  - b. Damage caused by carelessness on the users' part during product transportation.
  - c. Damage caused by fire, earthquakes, floods, lightening, pollution and incorrect usage of voltage transformers.
  - d. Damage caused by unsuitable storage environments with high temperatures, high humidity or volatile chemicals.
  - e. Damage caused by leakage of battery fluid when changing batteries.
  - f. Damages from improper repair by unauthorized technicians.
  - g. Products with altered and damaged serial numbers are not entitled to our service.
  - h. Other categories not protected under our guarantees
4. Customers are responsible for the fees regarding transportation of damaged products to our company or to the sales office.

5. To ensure the speed and quality of product repair, please download an RMA application form from our company website [www.adlinktech.com](http://www.adlinktech.com). Damaged products with RMA forms attached receive priority.

For further questions, please contact our FAE staff.

ADLINK: [service@adlinktech.com](mailto:service@adlinktech.com)

Test & Measurement Product Segment: [NuDAQ@adlinktech.com](mailto:NuDAQ@adlinktech.com)

Automation Product Segment: [Automation@adlinktech.com](mailto:Automation@adlinktech.com)

Computer & Communication Product Segment: [NuPRO@adlinktech.com](mailto:NuPRO@adlinktech.com);  
[NuIPC@adlinktech.com](mailto:NuIPC@adlinktech.com)