

NuDAQ®
DAQ-2204/2205/2206
PXI-2204/2205/2206
64-CH, High Performance
Multi-function Data Acquisition Cards
User's Guide



Recycle Paper

©Copyright 2002 ADLINK Technology Inc.
All Rights Reserved.

Manual Rev. 1.13: Oct 15, 2002

Part No: 50-11213-101

The information in this document is subject to change without prior notice in order to improve reliability, design and function and does not represent a commitment on the part of the manufacturer.

In no event will the manufacturer be liable for direct, indirect, special, incidental, or consequential damages arising out of the use or inability to use the product or documentation, even if advised of the possibility of such damages.

This document contains proprietary information protected by copyright. All rights are reserved. No part of this manual may be reproduced by any mechanical, electronic, or other means in any form without prior written permission of the manufacturer.

Trademarks

NuDAQ[®], NuIPC[®], NuDAM[®], NuPRO[®] are registered trademarks of ADLINK Technology Inc. Other product names mentioned herein are used for identification purposes only and may be trademarks and/or registered trademarks of their respective companies.

Getting service from ADLINK

- Customer Satisfaction is the most important priority for ADLINK Tech Inc. If you need any help or service, please contact us.

ADLINK Technology Inc.			
Web Site	http://www.adlinktech.com		
Sales & Service	Service@adlinktech.com		
Technical Support	NuDAQ + USBDAQ	nudaq@adlinktech.com	
	Automation	automation@adlinktech.com	
	NuIPC	nuipc@adlinktech.com	
	NuPRO / EBC	nupro@adlinktech.com	
TEL	+886-2-82265877	FAX	+886-2-82265717
Address	9F, No. 166, Jian Yi Road, Chungho City, Taipei, 235 Taiwan.		

- Please email or FAX us of your detailed information for a prompt, satisfactory and constant service.

Detailed Company Information			
Company/Organization			
Contact Person			
E-mail Address			
Address			
Country			
TEL		FAX	
Web Site			
Questions			
Product Model			
Environment to Use	OS: Computer Brand: M/B: CPU: Chipset: BIOS: Video Card: Network Interface Card: Other:		
Detail Description			
Suggestions to ADLINK			

Table of Contents

Tables	iv
Figures	v
How to Use This Guide	vii
Chapter 1 Introduction	1
1.1 Features	1
1.2 Applications	3
1.3 Specifications	3
1.4 Software Support	12
1.4.1 Programming Library	12
1.4.2 D2K-LVIEW: LabVIEW [®] Driver.....	12
1.4.3 PCIS-OCX: ActiveX Controls	13
Chapter 2 Installation	14
2.1 What You Have	14
2.2 Unpacking	15
2.3 DAQ/PXI-22XX Layout.....	15
2.4 PCI Configuration.....	16
Chapter 3 Signal Connections	17
3.1 Connectors Pin Assignment	17
3.2 Analog Input Signal Connection	21
3.2.1 Types of signal sources.....	21
3.2.2 Input Configurations.....	21
3.2.2.1 <i>Single-ended Connections</i>	21
3.2.2.2 <i>Differential input mode</i>	23

Chapter 4 Operation Theory	24
4.1 A/D Conversion.....	24
4.1.1 DAQ/PXI-2204 AI Data Format	25
4.1.1.1 <i>Synchronous Digital Inputs (for DAQ/PXI-2204 only)</i>	25
4.1.2 DAQ/PXI-2205/2206 AI Data Format	27
4.1.3 Software conversion with polling data transfer acquisition mode (Software Polling)	28
4.1.3.1 <i>Specifying Channels, Gains, and input configurations in the Channel Gain Queue</i>	28
4.1.4 Programmable scan acquisition mode	29
4.1.4.1 <i>Scan Timing and Procedure</i>	29
4.1.4.2 <i>Specifying Channels, Gains, and input configurations in the Channel Gain Queue</i>	31
4.1.4.3 <i>Trigger Modes</i>	32
4.1.4.4 <i>Bus-mastering DMA Data Transfer</i>	38
4.2 D/A Conversion.....	40
4.2.1 Software Update.....	41
4.2.2 Timed Waveform Generation	41
4.2.2.1 <i>Trigger Modes</i>	43
4.2.2.2 <i>Iterative Waveform Generation</i>	45
4.2.2.3 <i>Stop Modes of Scan Update</i>	46
4.3 Digital I/O.....	48
4.4 General Purpose Timer/Counter Operation	49
4.4.1 Timer/Counter functions basics	49
4.4.2 General Purpose Timer/Counter modes	49
4.4.2.1 <i>Mode1: Simple Gated- Event Counting</i>	50
4.4.2.2 <i>Mode2: Single Period Measurement</i>	50
4.4.2.3 <i>Mode 3: Single Pulse-width Measurement</i>	51
4.4.2.4 <i>Mode 4: Single Gated Pulse Generation</i>	51
4.4.2.5 <i>Mode5: Single Triggered Pulse Generation</i>	52
4.4.2.6 <i>Mode6: Re-triggered Single Pulse Generation</i>	52
4.4.2.7 <i>Mode7: Single Triggered Continuous Pulse Generation</i>	53
4.4.2.8 <i>Mode8: Continuous Gated Pulse Generation</i>	53

4.5	Trigger Sources	54
4.5.1	Software-Trigger.....	54
4.5.2	External Analog Trigger	54
4.5.2.1	<i>Below-Low analog trigger condition</i>	55
4.5.2.2	<i>Above-High analog trigger condition</i>	56
4.5.2.3	<i>Inside-Region analog trigger condition</i>	56
4.5.2.4	<i>High-Hysteresis analog trigger condition</i>	57
4.5.2.5	<i>Low-Hysteresis analog trigger condition</i>	57
4.5.3	External Digital Trigger.....	58
4.6	User-controllable Timing Signals	59
4.6.1	DAQ timing signals	60
4.6.2	Auxiliary Function Inputs (AFI).....	60
4.6.3	System Synchronization Interface.....	63
Chapter 5 Calibration		66
5.1	Loading Calibration Constants.....	66
5.2	Auto-calibration.....	67
5.3	Saving Calibration Constants.....	67
Warranty Policy		68

Tables

Table 1:	Programmable input range.....	4
Table 2:	-3dB small signal bandwidth	5
Table 3:	System Noise	6
Table 4:	Input impedance.....	6
Table 5:	CMRR (DC to 60Hz).....	6
Table 6:	Settling time to full-scale step.....	7
Table 7:	Legend of 68-pin VHDCI-type connectors	20
Table 8:	Bipolar analog input range and the output digital code on DAQ/PXI-2204.....	26
Table 9:	Unipolar analog input range and the output digital code on DAQ/PXI-2204.....	26
Table 10:	Bipolar analog input range and the output digital code on DAQ/PXI-2205/2206	27
Table 11:	Unipolar analog input range and the output digital code on DAQ/PXI-2205/2206	27
Table 12:	Bipolar output code table	40
Table 13:	Unipolar output code table	40
Table 14:	Analog trigger SRC1 ideal transfer characteristic ...	55
Table 15:	Auxiliary function input signals and the corresponding functionalities.....	61
Table 16:	Summary of SSI timing signals and the corresponding functionalities as the master or slave	63

Figures

Figure 1:	PCB Layout of DAQ-22XX.....	15
Figure 2:	PCB Layout of PXI-22XX.....	16
Figure 3:	Connector CN1 pin assignment.....	18
Figure 4:	Connector CN2 pin assignment.....	19
Figure 5:	Floating source and RSE input connections	22
Figure 6:	Ground-referenced sources and NRSE input connections	22
Figure 7:	Ground-referenced source and differential input....	23
Figure 8:	Floating source and differential input	23
Figure 9:	Synchronous Digital Inputs Block Diagram	25
Figure 10:	Synchronous Digital Inputs timing	25
Figure 11:	Scan Timing	30
Figure 12:	Pre-trigger (trigger occurs after M scans).....	32
Figure 13:	Pre-trigger (trigger with scan is in progress)	33
Figure 14:	Pre-trigger with M_enable = 0	34
Figure 15:	Pre-trigger with M_enable = 1	34
Figure 16:	Middle trigger with M_enable = 1.....	35
Figure 17:	Middle trigger.....	36
Figure 18:	Post trigger.....	36
Figure 19:	Delay trigger	37
Figure 20:	Post trigger with retrigger.....	38
Figure 21:	Scatter/gather DMA for data transfer.....	39
Figure 22:	Typical D/A timing of waveform generation.....	42
Figure 23:	Post trigger waveform generation.....	43
Figure 24:	Delay trigger waveform generation	44

Figure 25: Re-triggered waveform generation with Post-trigger and DLY2_Counter = 0.....	44
Figure 26: Finite iterative waveform generation with Post-trigger and DLY2_Counter = 0.....	45
Figure 27: Infinite iterative waveform generation with Post-trigger and DLY2_Counter = 0.....	46
Figure 28: Stop mode I.....	47
Figure 29: Stop mode II.....	47
Figure 30: Stop mode III	48
Figure 31: Mode 1 Operation	50
Figure 32: Mode 2 Operation	50
Figure 33: Mode 3 Operation	51
Figure 34: Mode 4 Operation	51
Figure 35: Mode 5 Operation	52
Figure 36: Mode 6 Operation	52
Figure 37: Mode 7 Operation	53
Figure 38: Mode 8 Operation	53
Figure 39: Analog trigger block diagram	54
Figure 40: Below-Low analog trigger condition	55
Figure 41: Above-High analog trigger condition	56
Figure 42: Inside-Region analog trigger condition.....	56
Figure 43: High-Hysteresis analog trigger condition	57
Figure 44: Low-Hysteresis analog trigger condition	57
Figure 45: External digital trigger	58
Figure 46: DAQ signals routing	59
Figure 47: Summary of user-controllable timing signals and the corresponding functionalities.....	59

How to Use This Guide

This manual is designed to help you use/understand the DAQ/PXI-22XX. The manual describes the versatile functions and the operation theory of the DAQ/PXI-22XX. It is divided into five chapters:

- Chapter 1, “Introduction,”** gives an overview of the product features, applications, and specifications.
- Chapter 2, “Installation,”** describes how to install DAQ/PXI-22XX. The layout and the positions of all the connectors on DAQ/PXI-22XX are shown.
- Chapter 3, “Signal Connections,”** describes the connector’s pin assignment and how to connect the outside signals to DAQ/PXI-22XX.
- Chapter 4, “Operation Theory,”** describes how DAQ/PXI-22XX operates. The A/D, D/A, GPIO, timer/counter, trigger and timing signal routing are introduced.
- Chapter 5, “Calibration,”** describes how to calibrate the DAQ/PXI-22XX for accurate measurements.

1

Introduction

The DAQ/PXI-22XX is an advanced data acquisition card based on the 32-bit PCI architecture. High performance designs and the state-of-the-art technology make this card ideal for data logging and signal analysis applications in medical, process control, etc.

1.1 Features

DAQ/PXI-22XX Advanced Data Acquisition Card provides the following advanced features:

- 32-bit PCI-Bus, plug and play
- Up to 64 single-ended inputs or 32 differential inputs, mixing of SE and DI analog input signals are possible
- 512 words analog input Channel Gain Queue configuration size
- DAQ/PXI-2204: 12-bit Analog input resolution with sampling rate up to 3MHz
- DAQ/PXI-2205: 16-bit Analog input resolution with sampling rate up to 500KHz
- DAQ/PXI-2206: 16-bit Analog input resolution with sampling rate up to 250KHz
- Programmable Bipolar/Unipolar analog input

- Programmable gain
 - ✓ DAQ/PXI-2204: x1, x2, x4, x5, x8, x10, x20, x40, x50, x200.
 - ✓ DAQ/PXI-2205/2206: x1, x2, x4, x8.
- A/D FIFO size: 1024 samples
- Versatile trigger sources: software trigger, external digital trigger, analog trigger and trigger from System Synchronization Interface (SSI)
- A/D Data transfer: software polling & bus-mastering DMA with Scatter/Gather functionality
- Four A/D trigger modes: post-trigger, delay-trigger, pre-trigger and middle-trigger
- 2 channel D/A outputs with waveform generation capability
- 1024 word length output data FIFO for D/A channels
- D/A Data transfer: software update and bus-mastering DMA with Scatter/Gather functionality
- System Synchronization Interface (SSI)
- A/D and D/A fully auto-calibration
- Completely jumper-less and software configurable

1.2 Applications

- Automotive Testing
- Cable Testing
- Transient signal measurement
- ATE
- Laboratory Automation
- Biotech measurement

1.3 Specifications

◆ Analog Input (AI)

- **Number of channels: (programmable)**
 - ✓ 64 single-ended (SE)
 - ✓ 32 differential input (DI)
 - ✓ Mixing of SE and DI analog signal sources (Software selectable per channel)
- **A/D converter**
 - ✓ 2204: LT1412 or equivalent
 - ✓ 2205: AD7665 or equivalent
 - ✓ 2206: AD7663 or equivalent
- **Maximum sampling rate:**
 - ✓ 2204: 3MS/s (for single channel)
 - ✓ 2205: 500KS/s
 - ✓ 2206: 250KS/s
- **Resolution:**
 - ✓ 2204: 12 bits, No missing codes
 - ✓ 2205/2206: 16 bits, No missing codes
- Input coupling: DC

- **Programmable input range:**

Device	Bipolar input range	Unipolar input range
2204	$\pm 10V$	--
	$\pm 5V$	0~10V
	$\pm 2.5V$	0~5V
	$\pm 2V$	0~4V
	$\pm 1.25V$	0~2.5V
	$\pm 1V$	0~2V
	$\pm 0.5V$	0~1V
	$\pm 0.25V$	0~0.5V
	$\pm 0.2V$	0~0.4V
	$\pm 0.05V$	0~0.1V
2205	$\pm 10V$	0~10V
	$\pm 5V$	0~5V
2206	$\pm 2.5V$	0~2.5V
	$\pm 1.25V$	0~1.25V

Table 1: Programmable input range

- **Operational common mode voltage range:** $\pm 11V$ maximum
- **Overvoltage protection:**
 - ✓ Power on: continuous $\pm 30V$
 - ✓ Power off: continuous $\pm 15V$
- **FIFO buffer size:** 1024 samples
- **Data transfers:**
 - ✓ Programmed I/O
 - ✓ Bus-mastering DMA with scatter/gather
- **Channel Gain Queue configuration size:** 512 words

- **-3dB small signal bandwidth: (Typical, 25°C)**

Device	Input range		Bandwidth (-3dB)
2204	$\pm 10V$	--	2000kHz
	$\pm 5V$	0~10V	
	$\pm 2.5V$	0~5V	
	$\pm 1.25V$	0~2.5V	
2204	$\pm 2V$	0~4V	1450kHz
	$\pm 0.5V$	0~1V	
2204	$\pm 1V$	0~2V	990kHz
	$\pm 0.25V$	0~0.5V	
2204	$\pm 0.2V$	0~0.4V	240kHz
	$\pm 0.05V$	0~0.1V	
2205	$\pm 10V$	0~10V	1600kHz
	$\pm 5V$	0~5V	1400kHz
	$\pm 2.5V$	0~2.5V	1000kHz
	$\pm 1.25V$	0~1.25V	600kHz
2206	$\pm 10V$	0~10V	760kHz
	$\pm 5V$	0~5V	720kHz
	$\pm 2.5V$	0~2.5V	610kHz
	$\pm 1.25V$	0~1.25V	450kHz

Table 2: -3dB small signal bandwidth

- **System Noise (LSBrms, including Quantization, Typical, 25°C)**

Device	Input Range	System Noise	Input Range	System Noise
2205	±10V	0.95 LSBrms	0~10V	1.5 LSBrms
	±5V	1.0 LSBrms	0~5V	1.6 LSBrms
	±2.5V	1.1 LSBrms	0~2.5V	1.7 LSBrms
	±1.25V	1.3 LSBrms	0~1.25V	1.9 LSBrms
2206	±10V	0.8 LSBrms	0~10V	0.9 LSBrms
	±5V	0.85 LSBrms	0~5V	1.0 LSBrms
	±2.5V	0.85 LSBrms	0~2.5V	1.0 LSBrms
	±1.25V	0.9 LSBrms	0~1.25V	1.2 LSBrms

Table 3: System Noise

- **Input impedance**

Normal Power On	Power Off	Overload
1GΩ / 100pF	820Ω	820Ω

Table 4: Input impedance

- **CMRR (DC to 60Hz, Typical)**

Device	Input Range	CMRR	Input Range	CMRR
2204	All ranges	90dB	--	--
2205	±10V	83dB	0~10V	87dB
	±5V	87dB	0~5V	90dB
2206	±2.5V	90dB	0~2.5V	92dB
	±1.25V	92dB	0~1.25V	93dB

Table 5: CMRR (DC to 60Hz)

- **Settling time to full-scale step: (Typical, 25°C)**

Device	Input Range		Condition	Settling time
2204	±10V		Multiple channels, multiple ranges. All samples in Unipolar OR Bipolar mode	1us to 0.1% error
	±5V	0~10V		
	±2.5V	0~5V		
	±2V	0~4V		
	±1.25V	0~2.5V		
	±0.5V	0~1V		
	±10V		Multiple channels, multiple ranges. All samples in Unipolar AND/OR Bipolar mode	1.25us to 0.1% error
	±5V	0~10V		
	±2.5V	0~5V		
	±2V	0~4V		
	±1.25V	0~2.5V		
	±0.5V	0~1V		
	±1V		Multiple channels, multiple ranges. All samples in Unipolar AND/OR Bipolar mode	2us to 0.1% error
	±0.25V	0~0.5V		
±0.2V		Multiple channels, multiple ranges. All samples in Unipolar AND/OR Bipolar mode	5us to 0.1% error	
±0.05V	0~0.1V			
2205	All Ranges		Multiple channels, multiple ranges. All samples in Unipolar OR Bipolar mode	2us to 0.1% error, 4us to 0.01% error
2206	All Ranges		Multiple channels, multiple ranges. All samples in Unipolar AND/OR Bipolar mode	2us to 0.2% error, 4us to 0.01% error

Table 6: Settling time to full-scale step

- **Time-base source:** Internal 40MHz or External clock Input (f_{\max} : 40MHz, f_{\min} : 1MHz, 50% duty cycle)
- **Trigger modes:** post-trigger, delay-trigger, pre-trigger and middle-trigger
- **Offset error:**
 - ✓ Before calibration: $\pm 60\text{mV}$ max
 - ✓ After calibration: $\pm 1\text{mV}$ max
- **Gain error:**
 - ✓ Before calibration: $\pm 0.6\%$ of output max
 - ✓ After calibration: $\pm 0.03\%$ of output max for DAQ/PXI-2204
 $\pm 0.01\%$ of output max for DAQ/PXI-2205/2206
- ◆ **Analog Output (AO)**
 - **Number of channels:** 2 analog voltage outputs
 - **D/A converter:** LTC7545 or equivalent
 - **Maximum update rate:** 1MS/s
 - **Resolution:** 12 bits
 - **FIFO buffer size:**
 - ✓ 512 samples per channel when both channels are enabled for timed output.
 - ✓ 1024 samples when only one channel is used for timed output.
 - **Data transfers:**
 - ✓ Programmed I/O,
 - ✓ Bus-mastering DMA with scatter/gather

- **Output range:** $\pm 10\text{V}$, $0\sim 10\text{V}$, $\pm\text{AOEXTREF}$, $0\sim\text{AOEXTREF}$
 - **Settling time:** $3\mu\text{S}$ to 0.5LSB accuracy
 - **Slew rate:** $20\text{V}/\mu\text{S}$
 - **Output coupling:** DC
 - **Protection:** Short-circuit to ground
 - **Output impedance:** 0.1Ω . max.
 - **Output driving:** $\pm 5\text{mA}$ max.
 - **Stability:** Any passive load, up to 1500pF
 - **Power-on state:** 0V steady-state
 - **Power-on glitch:** $\pm 1\text{V}/500\mu\text{S}$
 - **Offset error:**
 - ✓ Before calibration: $\pm 80\text{mV}$ max
 - ✓ After calibration: $\pm 1\text{mV}$ max
 - **Gain error:**
 - ✓ Before calibration: $\pm 0.8\%$ of output max
 - ✓ After calibration: $\pm 0.02\%$ of output max
- ◆ **General Purpose Digital I/O (G.P. DIO, 82C55A)**
- **Number of channels:** 24 programmable Input/Output
 - **Compatibility:** TTL
 - **Input voltage:**
 - ✓ Logic Low: $V_{IL}=0.8\text{ V}$ max.; $I_{IL}=0.2\text{mA}$ max.
 - ✓ High: $V_{IH}=2.0\text{V}$ max.; $I_{IH}=0.02\text{mA}$ max
 - **Output voltage:**
 - ✓ Low: $V_{OL}=0.5\text{ V}$ max.; $I_{OL}=8\text{mA}$ max.
 - ✓ High: $V_{OH}=2.7\text{V}$ min; $I_{OH}=400\mu\text{A}$

- **Synchronous Digital Inputs (SDI):** For DAQ/PXI-2204 only
- **Number of channels:** 4 digital inputs sampled simultaneously with the analog signal input.
- **Compatibility:** TTL/CMOS
- **Input voltage:**
 - ✓ Logic Low: $V_{IL}=0.8\text{ V max.}; I_{IL}=0.2\text{mA max.}$
 - ✓ High: $V_{IH}=2.0\text{V max.}; I_{IH}=0.02\text{mA max}$
- ◆ **General Purpose Timer/Counter (GPTC)**
 - **Number of channels:** 2 independent Up/Down Timer/Counters
 - **Resolution:** 16 bits
 - **Compatibility:** TTL
 - **Clock source:** Internal or external
 - **Max source frequency:** 10MHz
- ◆ **Analog Trigger (A.Trig)**
 - **Source:** All analog input channels; external analog trigger (EXTATRIG)
 - **Level:** \pm Full-scale, internal; $\pm 10\text{V}$ external
 - **Resolution:** 8 bits
 - **Slope:** Positive or negative (software selectable)
 - **Hysteresis:** Programmable
 - **Bandwidth:** 400khz
 - **External Analog Trigger Input (EXTATRIG):**
 - ✓ Input impedance: 40KO for DAQ/PXI-2204
20KO for DAQ/PXI-2205/2206
 - **Coupling:** DC
 - **Protection:** Continuous $\pm 35\text{V}$ maximum

- ◆ **Digital Trigger (D.Trig)**
 - **Compatibility:** TTL/CMOS
 - **Response:** Rising or falling edge
 - **Pulse Width:** 10ns min
- ◆ **System Synchronous Interface (SSI)**
 - **Trigger lines:** 7
- ◆ **Stability**
 - **Recommended warm-up time:** 15 minutes
 - **On-board calibration reference:**
 - ✓ Level: 5.000V
 - ✓ Temperature coefficient: $\pm 2\text{ppm}/^{\circ}\text{C}$
 - ✓ Long-term stability: 6ppm/1000Hr
- ◆ **Physical**
 - **Dimension:**
 - ✓ 175mm by 107mm for DAQ-22XX
 - ✓ Standard CompactPCI form factor for PXI-22XX
 - **I/O connector:** 68-pin female VHDCI type (e.g. AMP-787254-1)
- ◆ **Power Requirement (typical)**
 - **+5VDC:**
 - ✓ 3A for DAQ/PXI-2204
 - ✓ 2A for DAQ/PXI-2205/2206
- ◆ **Operating Environment**
 - **Ambient temperature:** 0 to 55°C
 - **Relative humidity:** 10% to 90% non-condensing
- ◆ **Storage Environment**
 - **Ambient temperature:** -20 to 70°C
 - **Relative humidity:** 5% to 95% non-condensing

1.4 Software Support

ADLINK provides versatile software drivers and packages for users' different approach to building up a system. ADLINK not only provides programming libraries such as DLL for most Windows based systems, but also provide drivers for other software packages such as LabVIEW[®].

All software options are included in the ADLINK CD. Non-free software drivers are protected with licensing codes. Without the software code, you can install and run the demo version for two hours for trial/demonstration purposes. Please contact ADLINK dealers to purchase the formal license.

1.4.1 Programming Library

For customers who are writing their own programs, we provide function libraries for many different operating systems, including:

- **D2K-DASK:** Include device drivers and DLL for **Windows 98**, **Windows NT** and **Windows 2000**. DLL is binary compatible across Windows 98, Windows NT and Windows 2000. This means all applications developed with D2K-DASK are compatible across Windows 98, Windows NT and Windows 2000. The developing environment can be VB, VC++, Delphi, BC5, or any Windows programming language that allows calls to a DLL. The user's guide and function reference manual of D2K-DASK are in the CD. (\\Manual_PDF\Software\D2K-DASK)
- **D2K-DASK/X:** Include device drivers and shared library for Linux. The developing environment can be Gnu C/C++ or any programming language that allows linking to a shared library. The user's guide and function reference manual of D2K-DASK/X are in the CD. (\\Manual_PDF\Software\D2K-DASK-X)

1.4.2 D2K-LVIEW: LabVIEW[®] Driver

D2K-LVIEW contains the VIs, which are used to interface with NI's LabVIEW[®] software package. The D2K-LVIEW supports Windows 98/NT/2000. The LabVIEW[®] drivers is shipped free with the card. You can install and use them without a license. For detailed information about D2K-LVIEW, please refer to the user's guide in the CD.

(\\Manual_PDF\Software\D2K-LVIEW)

1.4.3 PCIS-OCX: ActiveX Controls

We suggest customers who are familiar with ActiveX controls and VB/VC++ programming use PCIS-OCX ActiveX control component libraries for developing applications. PCIS-OCX is designed for Windows 98/NT/2000. For more detailed information about PCIS-OCX, please refer to the user's guide in the CD.

(Manual_PDF\Software\PCIS-OCX\PCIS-OCX.PDF)

The above software drivers are shipped with the card. Please refer to the "**Software Installation Guide**" in the package to install these drivers.

In addition, ADLINK supplies ActiveX control software *DAQBench*. *DAQBench* is a collection of ActiveX controls for measurement or automation applications. With *DAQBench*, you can easily develop custom user interfaces to display your data, analyze data you acquired or received from other sources, or integrate with popular applications or other data sources. For more detailed information about *DAQBench*, please refer to the user's guide in the CD.

(Manual_PDF\Software\DAQBench\DAQBenchManual.PDF)

You can also get a free 4-hour evaluation version of *DAQBench* from the CD.

DAQBench is not free. Please contact ADLINK dealer or ADLINK to purchase the software license.

2

Installation

This chapter describes how to install the DAQ/PXI-22XX. The contents of the package and unpacking information that you should be aware of are outlined first.

The DAQ/PXI-22XX performs an automatic configuration of the IRQ, and port address. Users can use software utility, PCI_SCAN to read the system configuration.

2.1 What You Have

In addition to this *User's Guide*, the package includes the following items:

- DAQ/PXI-22XX Multi-function Data Acquisition Card
- ADLINK All-in-one Compact Disc
- Software Installation Guide

If any of these items are missing or damaged, contact the dealer from whom you purchased the product. Save the shipping materials and carton in case you want to ship or store the product in the future.

2.2 Unpacking

Your DAQ/PXI-22XX SERIES card contains electro-static sensitive components that can be easily be damaged by static electricity.

Therefore, the card should be handled on a grounded anti-static mat. The operator should be wearing an anti-static wristband, grounded at the same point as the anti-static mat.

Inspect the card module carton for obvious damages. Shipping and handling may cause damage to your module. Be sure there are no shipping and handling damages on the modules carton before continuing.

After opening the card module carton, extract the system module and place it only on a grounded anti-static surface with component side up.

Again, inspect the module for damages. Press down on all the socketed IC's to make sure that they are properly seated. Do this only with the module placed on a firm flat surface.

Note: DO NOT APPLY POWER TO THE CARD IF IT HAS BEEN DAMAGED.

You are now ready to install your DAQ/PXI-22XX.

2.3 DAQ/PXI-22XX Layout

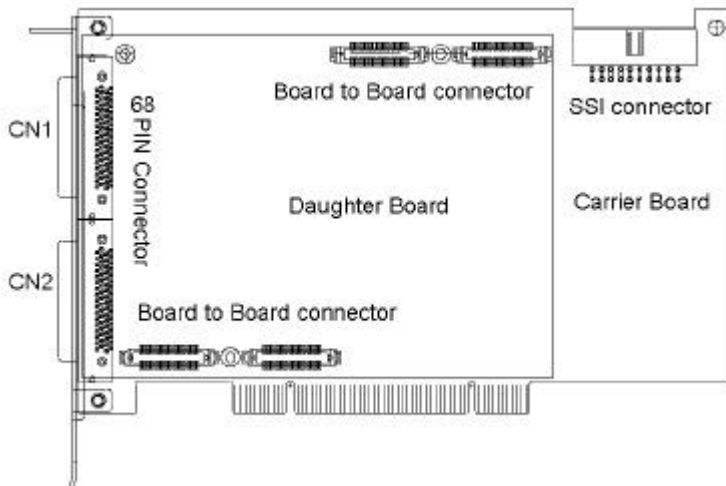

Figure 1: PCB Layout of DAQ-22XX

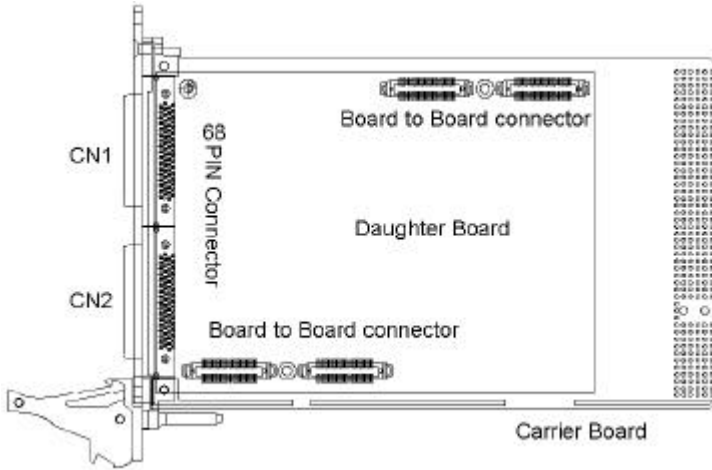

Figure 2: PCB Layout of PXI-22XX

2.4 PCI Configuration

1. Plug and Play:

As a plug and play component, the card requests an interrupt number via its PCI controller. The system BIOS responds with an interrupt assignment based on the card information and on known system parameters. These system parameters are determined by the installed drivers and the hardware load seen by the system.

2. Configuration:

The board configuration is done on a board-by-board basis for all PCI boards on your system. Because configuration is controlled by the system and software, there is no jumper setting required for base-address, DMA, and interrupt IRQ.

The configuration is subject to change with every boot of the system as new boards are added or removed.

3. Trouble shooting:

If your system doesn't boot or if you experience erratic operation with your PCI board in place, it's likely caused by an interrupt conflict (perhaps the BIOS Setup is incorrectly configured). In general, the solution, once you determine it is not a simple oversight, is to consult the BIOS documentation that comes with your system.

3

Signal Connections

This chapter describes the connectors of the DAQ/PXI-22XX, and the signal connection between the DAQ/PXI-22XX and external devices.

3.1 Connectors Pin Assignment

DAQ/PXI-22XX is equipped with two 68-pin VHDCI-type connectors (AMP-787254-1). It is used for digital input / output, analog input / output, and timer/counter signaling, etc. The pin assignment for the connectors are illustrated in the Figure 3 and Figure 4

AI0 (AIH0)	1	35	(AIL0)	AI32
AI1 (AIH1)	2	36	(AIL1)	AI33
AI2 (AIH2)	3	37	(AIL2)	AI34
AI3 (AIH3)	4	38	(AIL3)	AI35
AI4 (AIH4)	5	39	(AIL4)	AI36
AI5 (AIH5)	6	40	(AIL5)	AI37
AI6 (AIH6)	7	41	(AIL6)	AI38
AI7 (AIH7)	8	42	(AIL7)	AI39
AI8 (AIH8)	9	43	(AIL8)	AI40
AI9 (AIH9)	10	44	(AIL9)	AI41
AI10 (AIH10)	11	45	(AIL10)	AI42
AI11 (AIH11)	12	46	(AIL11)	AI43
AI12 (AIH12)	13	47	(AIL12)	AI44
AI13 (AIH13)	14	48	(AIL13)	AI45
AI14 (AIH14)	15	49	(AIL14)	AI46
AI15 (AIH15)	16	50	(AIL15)	AI47
AISENSE	17	51	AIGND	
AI16 (AIH16)	18	52	(AIL16)	AI48
AI17 (AIH17)	19	53	(AIL17)	AI49
AI18 (AIH18)	20	54	(AIL18)	AI50
AI19 (AIH19)	21	55	(AIL19)	AI51
AI20 (AIH20)	22	56	(AIL20)	AI52
AI21 (AIH21)	23	57	(AIL21)	AI53
AI22 (AIH22)	24	58	(AIL22)	AI54
AI23 (AIH23)	25	59	(AIL23)	AI55
AI24 (AIH24)	26	60	(AIL24)	AI56
AI25 (AIH25)	27	61	(AIL25)	AI57
AI26 (AIH26)	28	62	(AIL26)	AI58
AI27 (AIH27)	29	63	(AIL27)	AI59
AI28 (AIH28)	30	64	(AIL28)	AI60
AI29 (AIH29)	31	65	(AIL29)	AI61
AI30 (AIH30)	32	66	(AIL30)	AI62
AI31 (AIH31)	33	67	(AIL31)	AI63
EXTATRIG	34	68	AIGND	

Figure 3: Connector CN1 pin assignment

* Symbols in “()” are for differential mode connection.

DA0OUT	1	35	AOGND
DA1OUT	2	36	AOGND
AOEXTREF	3	37	AOGND
NC	4	38	NC
DGND	5	39	DGND
EXTWFTRIG	6	40	DGND
EXTDTRIG	7	41	DGND
SSHOUT	8	42	SDI0 / DGND*
RESERVED	9	43	SDI1 / DGND*
RESERVED	10	44	SDI2 / DGND*
AFI1	11	45	SDI3 / DGND*
AFI0	12	46	DGND
GPTC0_SRC	13	47	DGND
GPTC0_GATE	14	48	DGND
GPTC0_UPDOWN	15	49	DGND
GPTC0_OUT	16	50	DGND
GPTC1_SRC	17	51	DGND
GPTC1_GATE	18	52	DGND
GPTC1_UPDOWN	19	53	DGND
GPTC1_OUT	20	54	DGND
EXTTIMEBASE	21	55	DGND
PB7	22	56	PB6
PB5	23	57	PB4
PB3	24	58	PB2
PB1	25	59	PB0
PC7	26	60	PC6
PC5	27	61	PC4
DGND	28	62	DGND
PC3	29	63	PC2
PC1	30	64	PC0
PA7	31	65	PA6
PA5	32	66	PA4
PA3	33	67	PA2
PA1	34	68	PA0

Figure 4: Connector CN2 pin assignment

*Pin 42~45 are SDI<0..3> for DAQ/PXI-2204 ; DGND for DAQ/PXI-2205/2206

Legend:

Signal Name	Reference	Direction	Description
AIGND	-----	-----	Analog ground for AI. All three ground references (AIGND, AOGND, and DGND) are connected together on board
AI<0..63>	AIGND	Input	Analog Input Channels 0~63. Each channel pair, AI<i, i+32> (I=0..31) can be configured either two single-ended inputs or one differential input pair (marked as AIH<0..31> and AIL<0..31>)
AISENSE	AIGND	Input	Analog Input Sense. This pin is the reference for any channels AI<0..63> in NRSE input configuration
EXTATRIG	AIGND	Input	External AI analog trigger
DA0OUT	AOGND	Output	AO channel 0
DA1OUT	AOGND	Output	AO channel 1
AOEXTREF	AOGND	Input	External reference for AO channels
AOGND	-----	-----	Analog ground for AO
EXTWFRIG	DGND	Input	External AO waveform trigger
EXTDTRIG	DGND	Input	External AI digital trigger
RESERVED	-----	Output	Reserved for future use. Please leave it open
SDI<0..3> (for 2204 only)	DGND	Input	Synchronous digital inputs. These 4 digital inputs are sampled simultaneously with the analog signal input
GPTC<0,1>_SRC	DGND	Input	Source of GPTC<0,1>
GPTC<0,1>_GATE	DGND	Input	Gate of GPTC<0,1>
GPTC<0,1>_OUT	DGND	Input	Output of GPTC<0,1>
GPTC<0,1>_UPDOWN	DGND	Input	Up/Down of GPTC<0,1>
EXTTIMEBASE	DGND	Input	External Timebase
DGND	-----	-----	Digital ground
PB<7,0>	DGND	PIO*	Programmable DIO of 8255 Port B
PC<7,0>	DGND	PIO*	Programmable DIO of 8255 Port C
PA<7,0>	DGND	PIO*	Programmable DIO of 8255 Port A
AFI0	DGND	Input	Auxiliary Function Input 0 (ADCONV, AD_START)
AFI1	DGND	Input	Auxiliary Function Input 1 (DAWR, DA_START)

Table 7: Legend of 68-pin VHDCI-type connectors

3.2 Analog Input Signal Connection

The DAQ/PXI-22XX provides up to 64 single-ended or 32 differential analog input channels. You can fill the Channel Gain Queue to get desired combination of the input signal types. The analog signal can be converted to digital value by the A/D converter. To avoid ground loops and obtain a more accurate measurement from the A/D conversion, it is quite important to understand the signal source type and how to choose the analog input modes: RSE, NRSE, and DIFF mode.

3.2.1 Types of signal sources

Floating Signal Sources

A floating signal source means it is not connected in any way to the buildings ground system. A device with an isolated output is a floating signal source, such as optical isolator outputs, transformer outputs, and thermocouples.

Ground-Referenced Signal Sources

A ground-referenced signal means it is connected in some way to the buildings system. That is, the signal source is already connected to a common ground point with respect to the DAQ/PXI-22XX, assuming that the computer is plugged into the same power system. Non-isolated outputs of instruments and devices that plug into the buildings power system are ground-referenced signal sources.

3.2.2 Input Configurations

3.2.2.1 Single-ended Connections

A single-ended connection is used when the analog input signal is referenced to a ground that can be shared with other analog input signals. There are 2 different types for single-ended connections: RSE and NRSE configuration. In RSE configuration, the DAQ/PXI-22XX board provides the grounding point for the external analog input signals and is suitable for floating signal sources. While in NRSE configuration the board doesn't provide the grounding point, the external analog input signal provides its own reference grounding point and is suitable for ground-referenced signals.

Referenced Single-ended (RSE) Mode

In referenced single-ended mode, all the input signals are connected to the ground provided by the DAQ/PXI-22XX. It is suitable for connections with floating signal sources. Figure 5 shows an illustration. Note that when more than two floating sources are connected, these sources will be referenced to the same common ground.

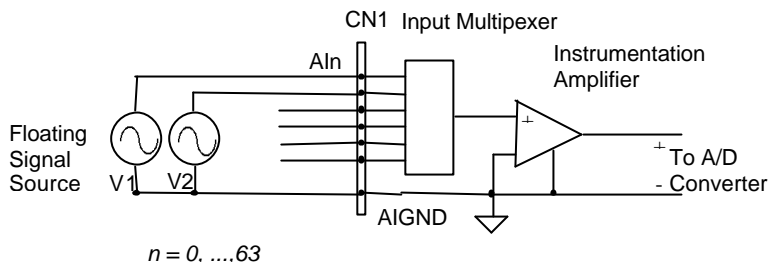

Figure 5: Floating source and RSE input connections

Non-Referenced Single-ended (NRSE) Mode

To measure ground-referenced signal sources, which are connected to the same ground point, you can connect the signals in NRSE mode. Fig 6 illustrates the connection. The signals local ground reference is connected to the negative input of the instrumentation Amplifier (AISENSE pin on CN1 connector), and the common-mode ground potential between signal ground and the ground on board will be rejected by the instrumentation amplifier.

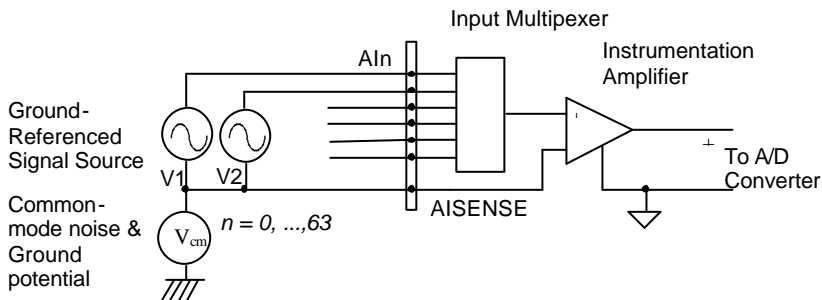

Figure 6: Ground-referenced sources and NRSE input connections

3.2.2.2 Differential input mode

The differential input mode provides two inputs that respond to signal voltage difference between them. If the signal source is ground-referenced, the differential mode can be used for the common-mode noise rejection. Figure 7 shows the connection of ground-referenced signal sources under differential input mode.

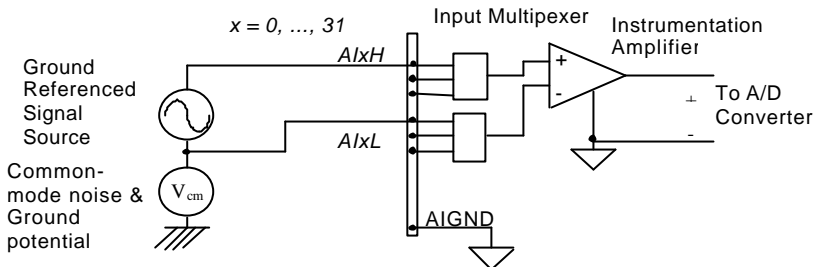

Figure 7: Ground-referenced source and differential input

Fig 8 shows how to connect a floating signal source to the DAQ/PXI-22XX in differential input mode. For floating signal sources, you need to add a resistor at each channel to provide a bias return path. The resistor value should be about 100 times the equivalent source impedance. If the source impedance is less than 100ohms, you can simply connect the negative side of the signal to AIGND as well as the negative input of the Instrumentation Amplifier without any resistors. In differential input mode, less noise couples into the signal connections than in single-ended mode.

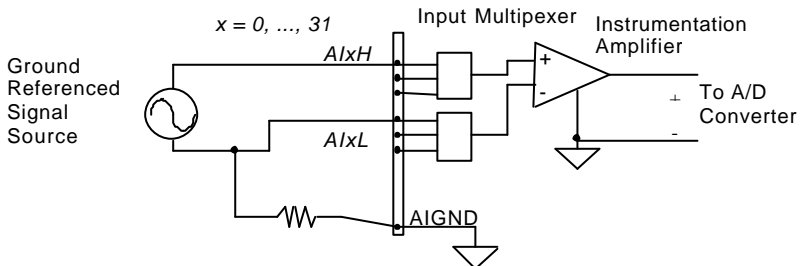

Figure 8: Floating source and differential input

4

Operation Theory

The operation theory of the functions on the DAQ/PXI-22XX is described in this chapter. The functions include the A/D conversion, D/A conversion, Digital I/O and General Purpose Counter / Timer. The operation theory can help you understand how to configure and program the DAQ/PXI-22XX.

4.1 A/D Conversion

When using an A/D converter, users should first know about the properties of the signal to be measured. Users can decide which channel to use and where to connect the signals to the card. Please refer to 3.2 for signal connections. In addition, users should define and control the A/D signal configurations, including channels, gains, and polarities (Unipolar/Bipolar).

The A/D acquisition is initiated by a trigger source; users must decide how to trigger the A/D conversion. The data acquisition will start once a trigger condition is matched.

After the end of an A/D conversion, the A/D data is buffered in a Data FIFO. The A/D data can now be transferred into the PC's memory for further processing.

Two acquisition modes, Software Polling and Scan acquisition are described below. Timing, trigger modes, trigger sources, and transfer methods are included.

4.1.1 DAQ/PXI-2204 AI Data Format

4.1.1.1 Synchronous Digital Inputs (for DAQ/PXI-2204 only)

When each AD conversion is completed, the 12-bit converted digital data accompanied with 4 bits of SDI<3..0> from CN2 will be latched into the 16-bit register and data FIFO, as shown in Fig 9 and Fig 10. Therefore, users can simultaneously sample one analog signal with four digital signals. The data format of every acquired 16-bit data is of the form:

D11, D10, D9 D1, D0, b3, b2, b1, b0

Where

D11, D10, D9 D1, D0: 2's complement A/D 12-bit data

b3, b2, b1, b0: Synchronous Digital Inputs SDI<3..0>

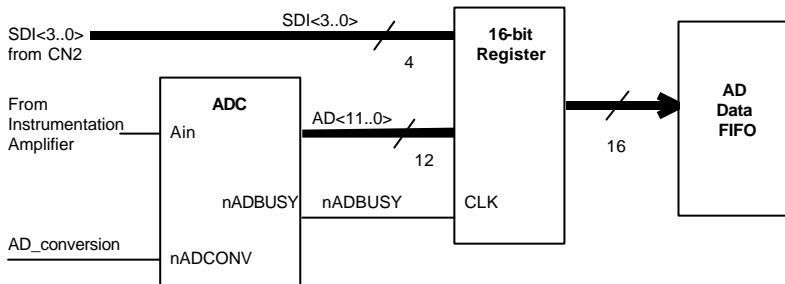

Figure 9: Synchronous Digital Inputs Block Diagram

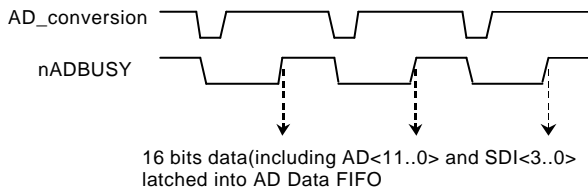

Figure 10: Synchronous Digital Inputs timing

Note: The analog signal is sampled when an AD conversion starts (falling edge of signal AD_conversion), while SDI<3..0> are sampled right after an AD conversion is completed (rising edge of signal nADBUSH). Precisely SDI<3..0> are sampled with 280ns lag to the analog signal.

Table 8 and 9 illustrate the ideal transfer characteristics of some input ranges.

Description	Bipolar Analog Input Range				Digital code
	$\pm 10V$	$\pm 5V$	$\pm 2.5V$	$\pm 1.25V$	
Full-scale Range	$\pm 10V$	$\pm 5V$	$\pm 2.5V$	$\pm 1.25V$	
Least significant bit	4.88mV	2.44mV	1.22mV	0.61mV	
FSR-1LSB	9.9951V	4.9976V	2.4988V	1.2494V	7FFX
Midscale +1LSB	4.88mV	2.44mV	1.22mV	0.61mV	001X
Midscale	0V	0V	0V	0V	000X
Midscale -1LSB	-4.88mV	-2.44mV	-1.22mV	-0.61mV	FFFX
-FSR	-10V	-5V	-2.5V	-1.25V	800X

Table 8: Bipolar analog input range and the output digital code on DAQ/PXI-2204 (Note that the last 4 digital codes are SDI<3..0>)

Description	Unipolar Analog Input Range			Digital code
	0V to 10V	0 to +5V	0 to +2.5V	
Full-scale Range	0V to 10V	0 to +5V	0 to +2.5V	
Least significant bit	2.44mV	1.22mV	0.61mV	
FSR-1LSB	9.9976V	4.9988V	2.9994V	7FFX
Midscale +1LSB	5.00244V	2.50122V	1.25061V	001X
Midscale	5V	2.5V	1.25V	000X
Midscale -1LSB	4.9976V	2.4988V	1.2494V	FFFX
-FSR	0V	0V	0V	800X

Table 9: Unipolar analog input range and the output digital code on DAQ/PXI-2204 (Note that the last 4 digital codes are SDI<3..0>)

4.1.2 DAQ/PXI-2205/2206 AI Data Format

The data format of the acquired 16-bit A/D data is 2's Complement coding. Table 10 and 11 shows the valid input ranges and the ideal transfer characteristics.

Description	Bipolar Analog Input Range				Digital code
	$\pm 10V$	$\pm 5V$	$\pm 2.5V$	$\pm 1.25V$	
Full-scale Range	$\pm 10V$	$\pm 5V$	$\pm 2.5V$	$\pm 1.25V$	
Least significant bit	305.2uV	152.6uV	76.3uV	38.15uV	
FSR-1LSB	9.999695V	4.999847V	2.499924V	1.249962V	7FFF
Midscale +1LSB	305.2uV	152.6uV	76.3uV	38.15uV	0001
Midscale	0V	0V	0V	0V	0000
Midscale -1LSB	-305.2uV	-152.6uV	-76.3uV	-38.15uV	FFFF
-FSR	-10V	-5V	-2.5V	-1.25V	8000

Table 10: Bipolar analog input range and the output digital code on DAQ/PXI-2205/2206

Description	Unipolar Analog Input Range				Digital code
	0V to 10V	0 to +5V	0 to +2.5V	0 to +1.25V	
Full-scale Range	0V to 10V	0 to +5V	0 to +2.5V	0 to +1.25V	
Least significant bit	152.6uV	76.3uV	38.15uV	19.07uV	
FSR-1LSB	9.999847V	4.999924V	2.499962V	1.249981V	7FFF
Midscale +1LSB	5.000153V	2.500076V	1.250038V	0.625019V	0001
Midscale	5V	2.5V	1.25V	0.625V	0000
Midscale -1LSB	4.999847V	2.499924V	1.249962V	0.624981V	FFFF
-FSR	0V	0V	0V	0V	8000

Table 11: Unipolar analog input range and the output digital code on DAQ/PXI-2205/2206

4.1.3 Software conversion with polling data transfer acquisition mode (Software Polling)

This is the easiest way to acquire a single A/D data. The A/D converter starts one conversion whenever the dedicated software command is executed. Then the software would poll the conversion status and read the A/D data back when it is available.

This method is very suitable for applications that needs to process A/D data in real time. Under this mode, the timing of the A/D conversion is fully controlled under software. However, it is difficult to control the A/D conversion rate.

4.1.3.1 Specifying Channels, Gains, and input configurations in the Channel Gain Queue

In Software Polling and Programmable Scan Acquisition mode, the channel, gain, polarity, and input configuration (RSE, NRSE, or DIFF) can be specified in the **Channel Gain Queue**. You can fill the channel number in the Channel Gain Queue in any order. The channel order of acquisition will be the same as the order you set in the Channel Gain Queue. Therefore, you can acquire data with user-defined channel orders and with different settings on each channel.

When the specified channels have been sampled from the first data to the last data in the Channel Gain Queue, the settings in Channel Gain Queue are maintained. You don't need to re-configure the Channel Gain Queue if you want to keep on sampling data in the same order. The maximum number of entries you can set in the Channel Gain Queue is 512.

Example:

First you can set entries in Channel Gain Queue:

Ch3 with bipolar $\pm 10V$, RSE connection

Ch1 with bipolar $\pm 2.5V$, DIFF connection

Ch2 with unipolar 5V, NRSE connection

Ch1 with bipolar $\pm 2.5V$, DIFF connection

If you read 10 data by software polling method

Then the acquisition sequence of channels is: 3, 1, 2, 1, 3, 1, 2, 1, 3, 1

4.1.4 Programmable scan acquisition mode

4.1.4.1 Scan Timing and Procedure

It's recommended that this mode be used if your applications need a fixed and precise A/D sampling rate. You can accurately program the period between conversions of individual channels. There are at least 4 counters, which need to be specified:

SI_counter (24 bit): Specify the **Scan Interval** = $SI_counter / Timebase$

SI2_counter (16 bit): Specify the data **Sampling Interval** =
 $SI2_counter / Timebase$

PSC_counter (24 bit): Specify **Post Scan Counts** after a trigger event

NumChan_counter (9 bit): Specify the **Number of samples per scan**

The acquisition timing and the meaning of the 4 counters are illustrated in figure 11

Timebase Clock Source

In scan acquisition mode, all the A/D conversions start on the output of counters, which use **Timebase** as the clock source. By software you can specify the Timebase to be either an internal clock source (on-board 40MHz) or an external clock input (EXTTIMEBASE) on CN2. The external clock is useful when you want to acquire data at rates not available with the internal A/D sample clock. The external clock source should generate TTL-compatible continuous clocks, and the maximum frequency is 40MHz while the minimum is 1MHz.

3 Scans, 4 Samples per scan
(PSC_Counter=3, NumChan_Counter=4)

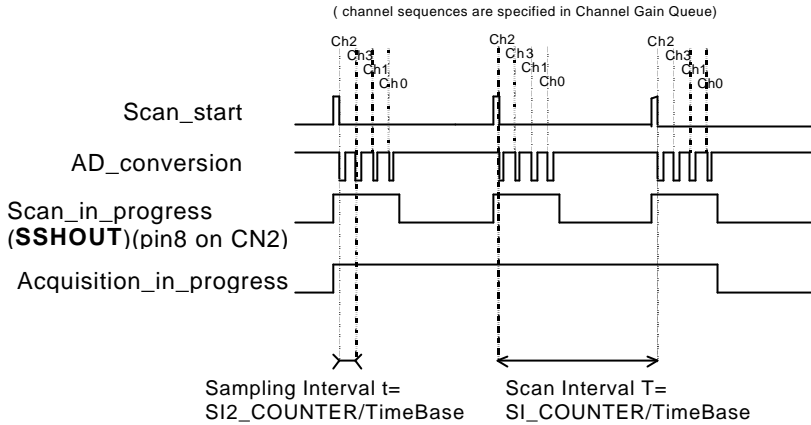

Figure 11: Scan Timing

There are 4 trigger modes to start the scan acquisition, please refer to 4.1.4.3 for the details. The data transfer mode will be discussed in 4.1.4.4.

Note:

1. The maximum A/D sampling rate is 3MHz for DAQ/PXI-2204, 500kHz for DAQ/PXI-2205 and 250kHz for DAQ/PXI-2206. Therefore, the minimum setting for SI2_counter is 14 for DAQ/PXI-2204, 80 for DAQ/PXI-2205 and 160 for DAQ/PXI-2206 while using the internal Timebase.
 2. The SI_counter is a 24-bit counter and the SI2_counter is a 16-bit counter. Therefore, the maximum scan interval using the internal Timebase = $2^{24} / 40\text{M s} = 0.419\text{s}$, and the maximum sampling interval between 2 channels using the internal Timebase = $2^{16} / 40\text{M s} = 1.638\text{ms}$.
 3. The scan interval can't be smaller than the product of the data sampling interval and the NumChan_counter value. The relationship can be represented as: $\text{SI_counter} \geq \text{SI2_counter} * \text{NumChan_counter}$.
-

Scan with SSH

You can send the SSHOUT signal on CN2 to an external S&H circuits to sample and hold all signals if you want to simultaneously sample all channels in a scan, as illustrated in fig 11.

Note: The 'SSHOUT' signal is sent to external S&H circuits to hold the analog signal. Users must implement external S&H circuits on their own to carry out the S&H function. There are no on-board S&H circuits.

4.1.4.2 Specifying Channels, Gains, and input configurations in the Channel Gain Queue

Like software polling acquisition mode, the channel, gain, and input configurations can be specified in the **Channel Gain Queue** under the scan acquisition mode. Please refer to 4.1.3.1. Note that in scan acquisition mode the number of entries in the Channel Gain Queue is normally equivalent to the value of NumChan_counter (that is, the number of samples per scan).

Example:

Set

SI2_counter = 160

SI_counter = 640

PSC_counter = 3

NumChan_counter = 4

Timebase = Internal clock source

Channel entries in the Channel Gain Queue: ch1, ch2, ch0, ch2

Then

Acquisition sequence of channels: 1, 2, 0, 2, 1, 2, 0, 2, 1, 2, 0, 2

Sampling Interval = $160/40M$ s = 4 us

Scan Interval = $640/40M$ s = 16 us

Equivalent sampling rate of ch0, ch1: 62.5kHz

Equivalent sampling rate of ch2: 125kHz

4.1.4.3 Trigger Modes

DAQ/PXI-22XX provides 3 trigger sources (internal software, external analog and digital trigger sources). You must select one of them as the source of the trigger event. A trigger event occurs when the specified condition is detected on the selected trigger source (For example, a rising edge on the external digital trigger input).

There are 4 trigger modes (pre-trigger, post-trigger, middle-trigger, and delay-trigger) working with the 4 trigger sources to initiate different scan data acquisition timing when a trigger event occurs. They are described as follows. For information of trigger sources, please refer to section 4.5.

Pre-Trigger Acquisition

Use pre-trigger acquisition in applications where you want to collect data before a trigger event. The A/D starts when you execute the specified function calls to begin the operation, and it stops when the external trigger event occurs. Users must program the value M in **M_counter** (16bit) to specify the amount of stored scanned data before the trigger event. If an external trigger occurs after M scans of data are converted, the program only stores the last M scans of data, as illustrated in fig 12, where $M_counter = M = 3$, $NumChan_counter = 4$, $PSC_counter = 0$. The total stored amount of data = $NumChan_counter * M_counter = 12$.

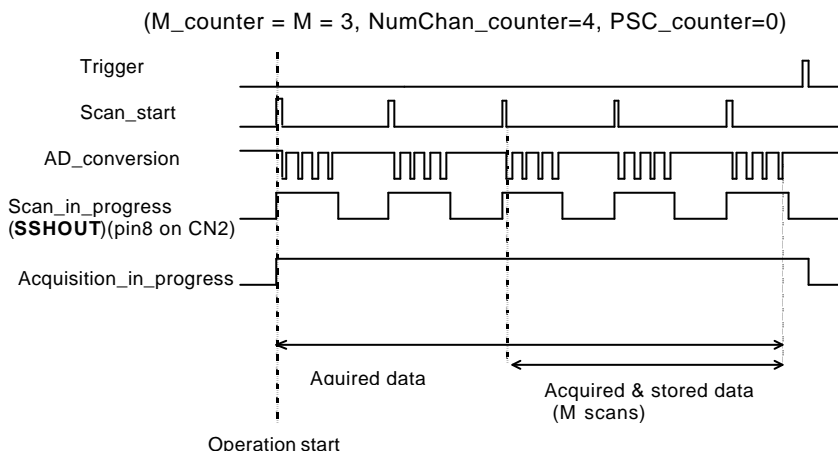

Figure 12: Pre-trigger (trigger occurs after M scans)

Note that if a trigger event occurs when a scan is in progress, the data acquisition won't stop until the scan completes, and the stored M scans of data includes the last scan. **Therefore, the first stored data will always be the first channel entry of a scan (that is, the first channel entry in the Channel Gain Queue if the number of entries in the Channel Gain Queue is equivalent to the value of NumChan_counter), no matter when a trigger signal occurs,** as illustrated in Fig 13, where $M_counter = M = 3$, $NumChan_counter = 4$, $PSC_counter = 0$.

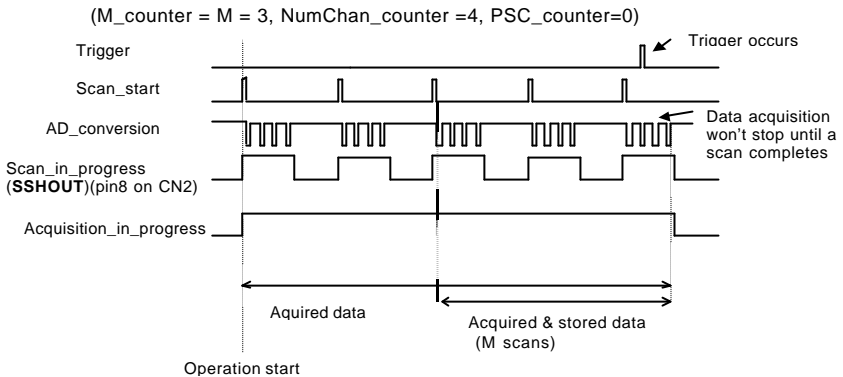

Figure 13: Pre-trigger (trigger with scan is in progress)

When a trigger signal occurs before the first M scans of data are converted, the amount of stored data could be fewer than the originally specified amount in $NumChan_counter * M_counter$, as illustrated in fig 14. This situation can be avoided by setting **M_enable**. If **M_enable** is set to 1, the trigger signal will be ignored until the first M scans of data are converted, and it assures user can get M scans of data under pre-trigger mode, as illustrated in fig 4.1.5. However, if **M_enable** is set to 0, the trigger signal will be accepted in any time, as illustrated in fig 15. Note that the total amount of stored data is still always a multiple of $NumChan_counter$ (number of samples per scan) because the data acquisition won't stop until a scan is completed.

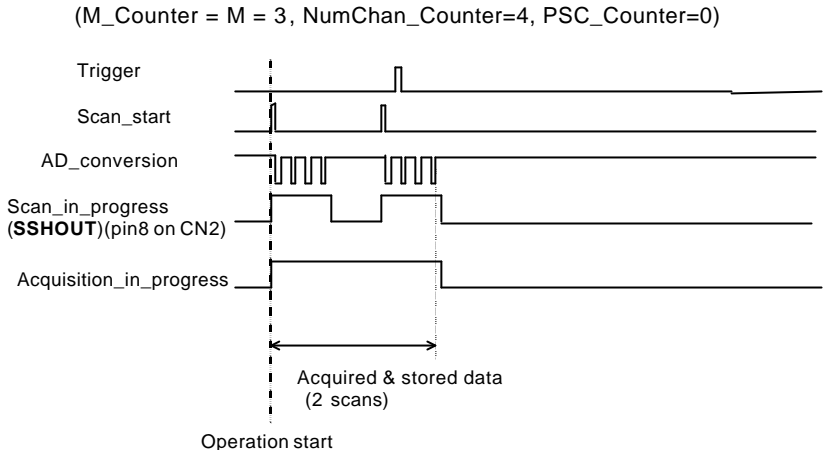

Figure 14: Pre-trigger with M_enable = 0 (trigger occurs before M scans)

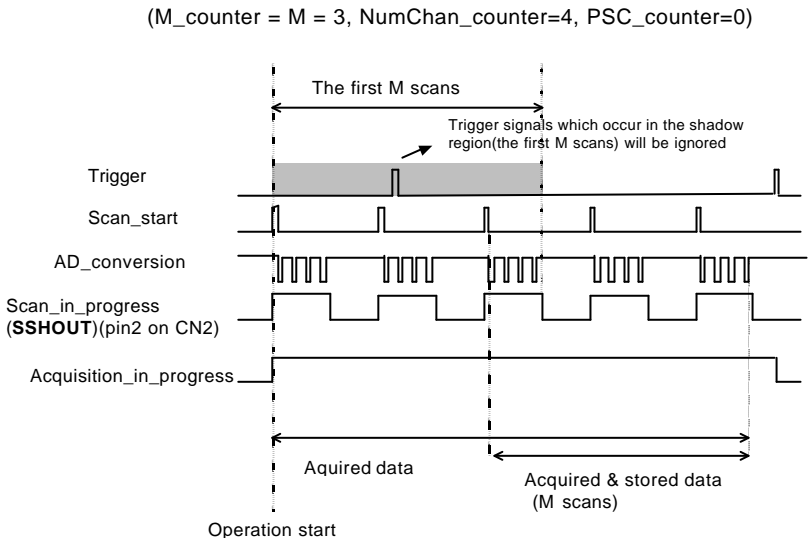

Figure 15: Pre-trigger with M_enable = 1

Note: The PSC_counter is set to 0 in pre-trigger acquisition mode.

Middle-Trigger Acquisition

Use middle-trigger acquisition in applications where you want to collect data before and after a trigger event. The number of scans (M) stored before the trigger is specified by `M_counter`, while the number of scans (N) after the trigger is specified by `PSC_counter`.

Like pre-trigger mode, the number of stored data could be fewer than the specified amount of data ($\text{NumChan_counter} * (M+N)$) if an external trigger occurs before M scans of data are converted. The **M_enable** bit in middle-trigger mode takes the same effect as in pre-trigger mode. If **M_enable** is set to 1, the trigger signal will be ignored until the first M scans of data are converted, and it assures users can get (M+N) scans of data under middle-trigger mode. However, if **M_enable** is set to 0, the trigger signal will be accepted at any time. Fig 16 shows the acquisition timing with `M_enable=1`.

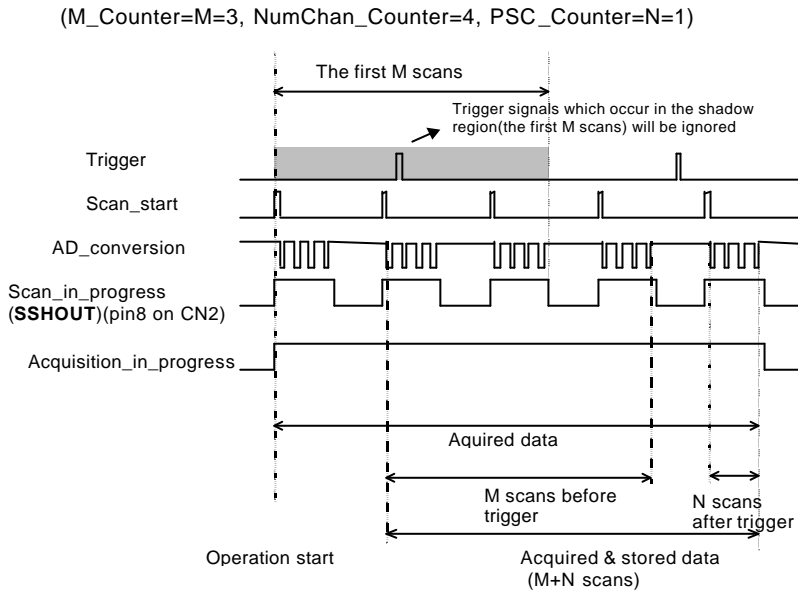

Figure 16: Middle trigger with `M_enable = 1`

If a trigger event occurs when a scan is in progress, the stored N scans of data would include this scan. **And the first stored data will always be the first channel entry of a scan**, as illustrated in Fig 17.

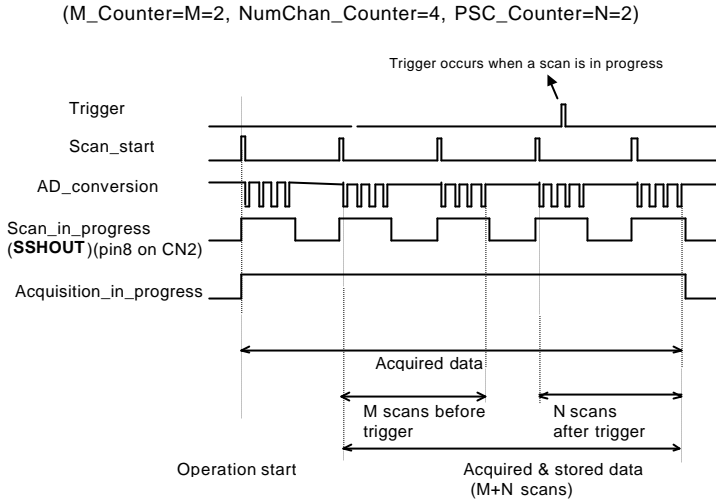

Figure 17: Middle trigger (trigger occurs when a scan is in progress)

Post-Trigger Acquisition

Use post-trigger acquisition in applications where you want to collect data after a trigger event. The number of scans after the trigger is specified in PSC_counter, as illustrated in fig 18. The total acquired data length = NumChan_counter * PSC_counter.

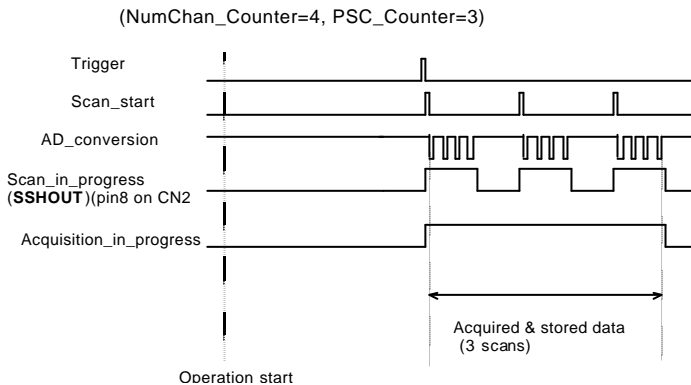

Figure 18: Post trigger

Delay Trigger Acquisition

Use delay trigger acquisition in applications where you want to delay the data collecting process after the occurrence of a specified trigger event. The delay time is controlled by the value, which is pre-loaded in the **Delay_counter** (16bit). The counter counts down on the rising edge of the Delay_counter clock source after the trigger condition is met. The clock source is software programmed and can be either the Timebase clock (40MHz) or the A/D sampling clock (Timebase /SI2_counter). When the count reaches 0, the counter stops and the board starts to acquire data. The total acquired data length = NumChan_counter * PSC_counter.

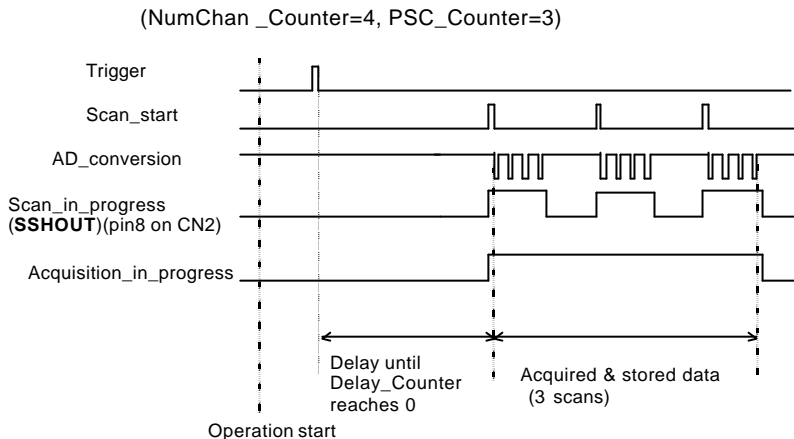

Figure 19: Delay trigger

Note: When the Delay_counter clock source is set to Timebase, the maximum delay time = $2^{16}/40M$ s = 1.638ms, and when set to A/D sampling clock, the maximum delay time can be higher ($2^{16} * SI2_counter / 40M$).

Post-Trigger or Delay-trigger Acquisition with retrigger

Use post-trigger or delay-trigger acquisition with re-trigger function in applications where you want to collect data after several trigger events. The number of scans after each trigger is specified in PSC_counter, and users could program **Retrig_no** to specify the re-trigger numbers. Fig 20 illustrates an example. In this example, 2 scans of data is acquired after the first trigger signal, then the board waits for the re-trigger signal (re-trigger signals which occur before the first 2 scans of data acquired will be ignored). When the re-trigger signal occurs, the board scans 2 more scans of

data. The process repeats until the specified amount of re-trigger signals are detected. The total acquired data length = NumChan_counter * PSC_counter * Retrig_no.

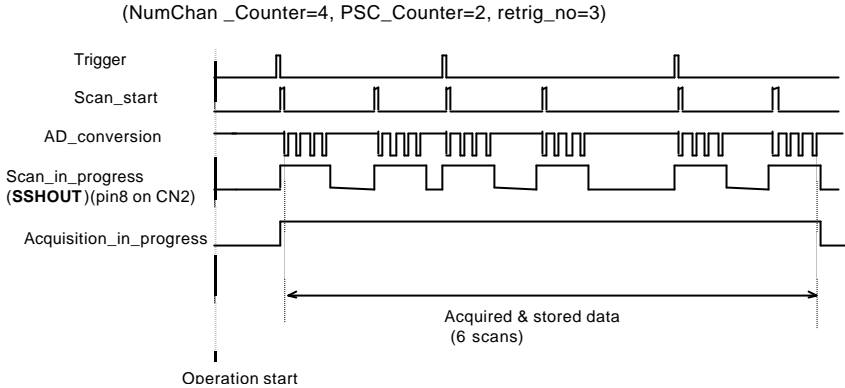

Figure 20: Post trigger with retrigger

4.1.4.4 Bus-mastering DMA Data Transfer

PCI bus-mastering DMA is necessary for high speed DAQ in order to utilize the maximum PCI bandwidth. The bus-mastering controller, which is built in the PLX IOP-480 PCI controller, controls the PCI bus when it becomes the master of the bus. Bus mastering reduces the size of the on-board memory and reduces the CPU loading because data is directly transferred to the computer's memory without host CPU intervention.

Bus-mastering DMA provides the fastest data transfer rate on PCI-bus. Once the analog input operation starts, control returns to your program. The hardware temporarily stores the acquired data in the on-board AD Data FIFO and then transfers the data to a user-defined DMA buffer memory in the computer. Please note that even when the acquired data length is less than the Data FIFO, the AD data will not be kept in the Data FIFO but directly transferred into host memory by the bus-mastering DMA.

The DMA transfer mode is very complex to program. We recommend using a high-level program library to configure this card. If users would like to know more about programs/software's that can handle the DMA bus master data transfer, please refer to <http://www.plxtech.com> for more information on PCI controllers.

By using a high-level programming library for high speed DMA data acquisition, users simply need to assign the sampling period and the number

of conversion into their specified counters. After the AD trigger condition is matched, the data will be transferred to the system memory by the bus-mastering DMA.

The PCI controller also supports the function of scatter/gather bus mastering DMA, which helps the users to transfer large amounts of data by linking all the memory blocks into a continuous linked list.

In a multi-user or multi-tasking OS, like Microsoft Windows, Linux, and so on, it is difficult to allocate a large continuous memory block to do the DMA transfer. Therefore, the PLX IOP-480 provides the function of scatter/gather or chaining mode DMA to link the non-continuous memory blocks into a linked list so that users can transfer very large amounts of data without being limited by the fragment of small size memory. Users can configure the linked list for the input DMA channel or the output DMA channel. Figure 21 shows a linked list that is constructed by three DMA descriptors. Each descriptor contains a PCI address, a local address, a transfer size, and the pointer to the next descriptor. Users can allocate many small size memory blocks and chain their associative DMA descriptors altogether by their application programs. DAQ/PXI-22XX software driver provides simple settings of the scatter/gather function, and some sample programs are also provided within the ADLINK all-in-one CD.

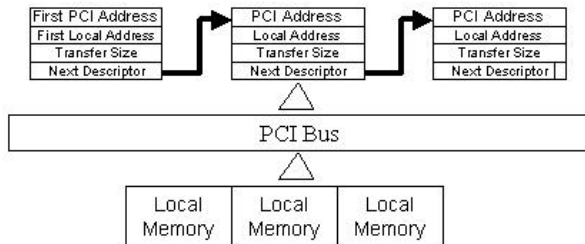

Figure 21: Scatter/gather DMA for data transfer

In non-chaining mode, the maximum DMA data transfer size is 2M double words (8M bytes). However, by using chaining mode, scatter/gather, there is no limitation on DMA data transfer size. Users can also link the descriptor nodes circularly to achieve a multi-buffered mode DMA.

4.2 D/A Conversion

There are 2 channels of 12-bit D/A output available in the DAQ/PXI-22XX. When using D/A converters, users should assign and control the D/A converter reference sources for the D/A operation mode and D/A channels. Users could also select the output polarity: unipolar or bipolar.

The reference selection control lets users fully utilize the multiplying characteristics of the D/A converters. Internal 10V reference and external reference inputs are available in the DAQ/PXI-22XX. The range of the D/A output is directly related to the reference. The digital codes that are updated to the D/A converters will multiply with the reference to generate the analog output. While using internal 10V reference, the full range would be $-10V \sim +9.9951V$ in the bipolar output mode, and $0V \sim 9.9976V$ in the unipolar output mode. While using an external reference, users can reach different output ranges by connecting different references. For example, if connecting a DC $-5V$ with the external reference, then the users can get a full range from $-4.9976V$ to $+5V$ in the bipolar output with inverting characteristics due to the negative reference voltage. Users could also have an amplitude modulated (AM) output by feeding a sinusoidal signal into the reference input. The range of the external reference should be within $\pm 10V$. Table 12 and 13 illustrates the relationship between digital code and output voltages

Digital Code	Analog Output
111111111111	$V_{ref} * (2047/2048)$
100000000001	$V_{ref} * (1/2048)$
100000000000	0V
011111111111	$-V_{ref} * (1/2048)$
000000000000	$-V_{ref}$

Table 12: Bipolar output code table($V_{ref}=10V$ if internal reference is selected)

Digital Code	Analog Output
111111111111	$V_{ref} * (4095/4096)$
100000000000	$V_{ref} * (2048/4096)$
000000000001	$V_{ref} * (1/4096)$
000000000000	0V

Table 13: Unipolar output code table ($V_{ref}=10V$ if internal reference is selected)

The D/A conversion is initiated by a trigger source. Users must decide how to trigger the D/A conversion. The data output will start when a trigger condition is met. Before the start of D/A conversion, D/A data is transferred from PC's main memory to a buffering Data FIFO.

There are two modes of the D/A conversion: Software Update and Timed Waveform Generation are described, including timing, trigger source control, trigger modes and data transfer methods. **Either mode may be applied to D/A channels independently.** You can software update DA CH0 while generate timed waveforms on CH1 at the same time.

4.2.1 Software Update

This is the easiest way to generate D/A output. First, users should specify the D/A output channels, set output polarity: unipolar or bipolar, and reference source: internal 10V or external AOEXTREF. Then update the digital values into D/A data registers through a software output command.

4.2.2 Timed Waveform Generation

This mode can provide your applications with a precise D/A output with a fixed update rate. It can be used to generate an infinite or finite waveform. You can accurately program the update period of the D/A converters.

The D/A output timing is provided through a combination of counters in the FPGA on board. There are totally 5 counters to be specified. These counters are:

- | | |
|------------------------|--|
| UI_counter(24 bits): | specify the DA Update Interval = CHUI_counter/Timebase. |
| UC_counter(24 bits): | specify the total Update Counts in a single waveform |
| IC_counter(24 bits): | specify the Iteration Counts of waveform. |
| DLY1_counter(16 bits): | specify the Delay from the trigger to the first update start. |
| DLY2_counter(16 bits): | specify the Delay between two consecutive waveform generations. |

Figure 22 shows the typical D/A timing diagram. D/A updates its output on each rising edge of DAWR. The meaning of the counters above is discussed more in the following sections. For more information of Timebase, please refer to 4.1.2.1.

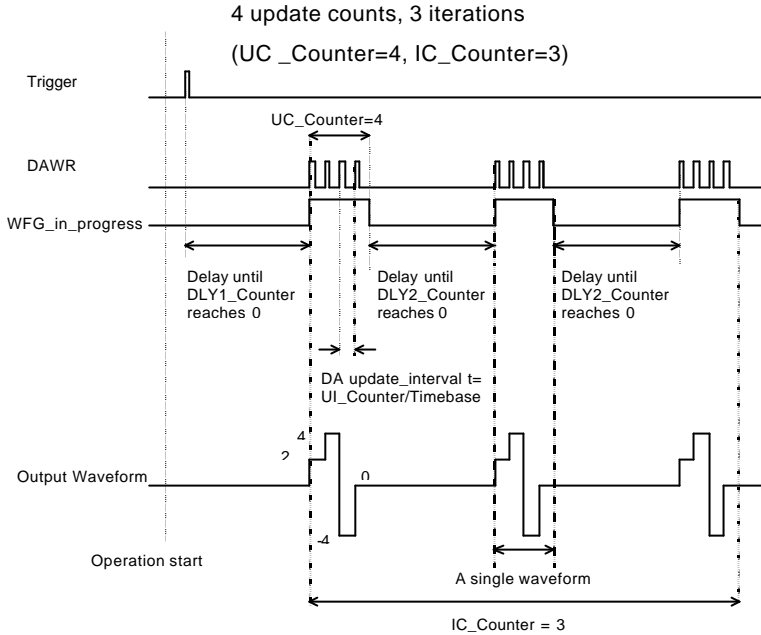

**Figure 22: Typical D/A timing of waveform generation
(Assuming the data in the data buffer are 2V, 4V, -4V, 0V)**

Note: The maximum D/A update rate is 1MHz. Therefore; the minimum setting of UI_counter is 40 while using the internal Timebase (40MHz).

4.2.2.1 Trigger Modes

Post-Trigger Generation

Use post trigger when you want to perform DA waveform right after a trigger event occurs. In this trigger mode DLY1_Counter is not used and you don't need to specify it. Figure 23 shows a single waveform generated right after a trigger signal is detected. The trigger signal could come from a software command, an analog trigger or a digital trigger. Please refer to section 4.5 for detailed information.

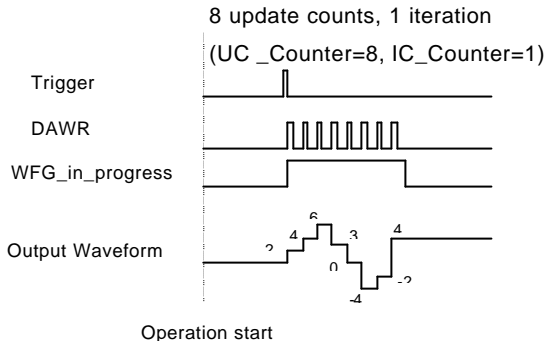

Figure 23: Post trigger waveform generation

(Assuming the data in the data buffer are 2V, 4V, 6V, 3V, 0V, -4V, -2V, 4V)

Delay-Trigger Generation

Use delay trigger when you want to delay the waveform generation after a trigger event. In figure 24, DA_DLY1_counter determines the delay time from the trigger signal to the start of the waveform generation. DLY1_counter counts down on the rising edge of its clock source after the trigger condition is met. When the count reaches 0, the counter stops and the DAQ/PXI-22XX starts the waveform generation. This DLY1_Counter is 16-bit's wide and users can set the delay time in units of TIMEBASE (delay time = DLY1_Counter/TIMEBASE) or in units of update period (delay time = DLY1_Counter * UI_counter/TIMEBASE), such that the delay time can reach a wider range.

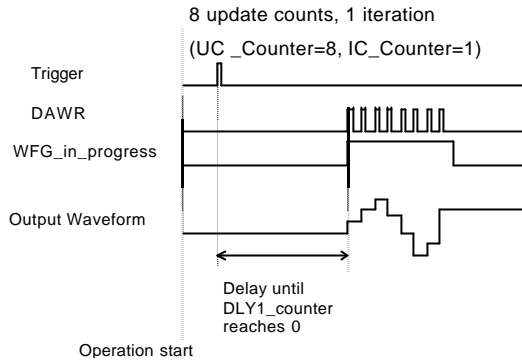

Figure 24: Delay trigger waveform generation
(Assuming the data in the data buffer are 2V, 4V, 6V, 3V, 0V, -4V, -2V, 4V)

Post-Trigger or Delay-Trigger with Re-trigger

Use post-trigger or delay-trigger with re-trigger function when you want to generate waveform after more than one trigger events. The re-trigger function can be enabled or disabled by software setting. In figure 25, each trigger signal will generate 2 single waveforms (since IC_Counter = 2), and you can set **Retrig_no** to specify the number of the accepted re-trigger signals. Note that a trigger would be ignored if it occurs during waveform generation.

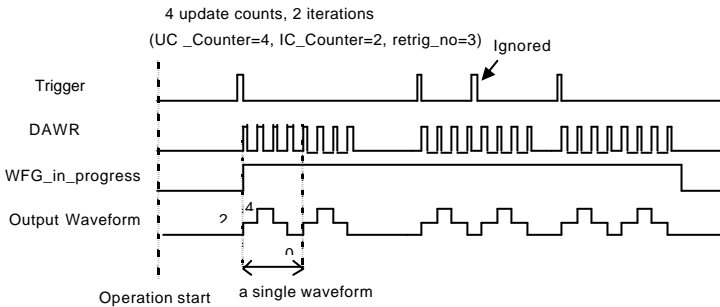

Figure 25: Re-triggered waveform generation with Post-trigger and DLY2_Counter = 0

(Assuming the data in the data buffer are 2V, 4V, 2V, 0V)

4.2.2.2 Iterative Waveform Generation

Set IC_Counter in order to generate iterative waveforms from the data of a single waveform. The counter stores the iteration number, and the iterations could be finite (Figure 26) or infinite(Figure 27). Note that in infinite mode the waveform generation won't stop until software stop function is executed, and **IC_Counter is still meaningful when stop mode III is selected**. Please refer to 4.2.2.3 for details.

A data FIFO on board is used to buffer the digital data for DA output. If the data size of a single waveform specified (That is, Update Counts in UC_Counter) is less than the FIFO size, after initially transferring the data from host PC memory to the FIFO on board, the data in FIFO will be automatically re-transmitted whenever a single waveform is completed. Therefore, it won't occupy the PCI bandwidth when the iterative waveforms are performed. However, if the data size of a single waveform specified is more than the FIFO size, it needs to intermittently perform DMA to transfer data from host PC memory to the FIFO on board when the iterative waveforms are performed and occupies PCI bandwidth. The data FIFO size on the DAQ/PXI-22XX is 1024(words) when one DA channel is enabled, and 512(words) when both DA channels are enabled.

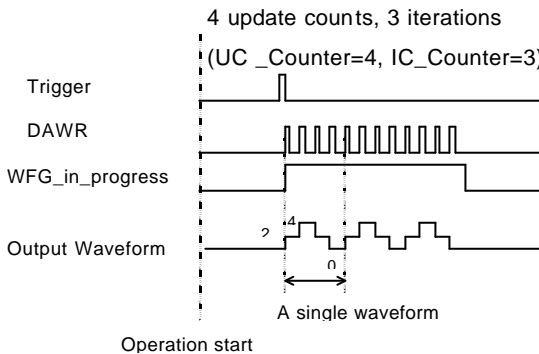

Figure 26: Finite iterative waveform generation with Post-trigger and DLY2_Counter = 0

(Assuming the data in the data buffer are 2V, 4V, 2V, 0V)

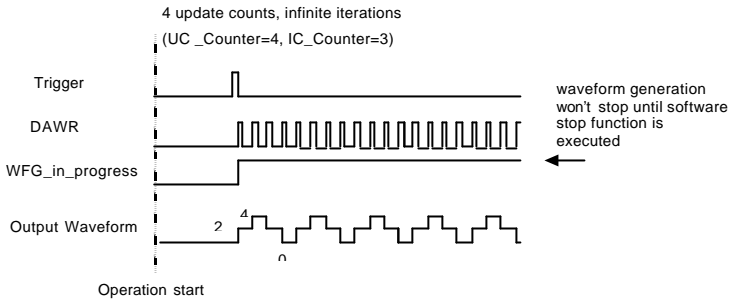

Figure 27: Infinite iterative waveform generation with Post-trigger and DLY2_Counter = 0
(Assuming the data in the data buffer are 2V, 4V, 2V, 0V)

Delay2 in iterative Waveform Generation

To stretch out the flexibility of the D/A waveform generation, we add a DLY2 Counter to separate 2 consecutive waveforms in iterative waveform generation. The time between two waveforms is assigned by setting the value of DLY2_Counter. The DLY2_Counter counts down after a complete waveform generation, and when it counts down to zero, the next waveform generation will start. This DLY2_Counter is 16-bits wide and users can set the delay time in the unit of Timebase (delay time = DLY2_Counter/Timebase) or in the unit of update period (delay time = DLY2_Counter * UI_Counter/Timebase), such that the delay time could reach a wide range.

4.2.2.3 Stop Modes of Scan Update

You can call software stop function to stop waveform generation when it is still in progress. Three stop modes are provided for timed waveform generation, which means when is it to stop the waveform generation. You can apply these 3 modes to stop waveform generation no matter infinite or finite waveform generation mode is selected.

Figure 28 illustrates a n example for stop mode I, in this mode the waveform stops immediately when software command is asserted.

In stop mode II, after a software stop command is given, the waveform generation won't stop until a complete single waveform is finished. See figure 29 for an example, since UC_Counter is set to 4, the total DA updates counts (that is, number of pulses of DAWR signal) must be a multiple of 4 (update counts = 20 in this example).

In stop mode III, after a software stop command is given, the waveform generation won't stop until the performed number of waveforms is a multiple of $IC_Counter$. See figure 30 for an example, since $IC_Counter$ is set to 3, the total generated waveforms must be a multiple of 3 (waveforms = 6 in this example), and the total DA update counts must be a multiple of 12 ($UC_Counter * IC_Counter$). You can compare these three figures for their differences.

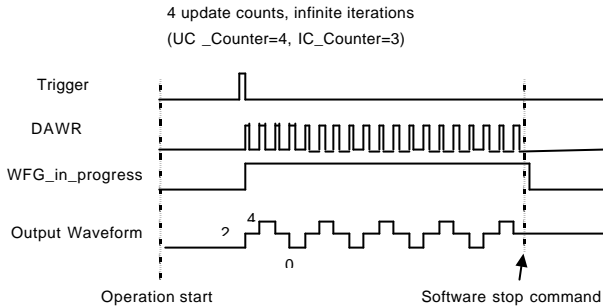

Figure 28: Stop mode I
(Assuming the data in the data buffer are 2V, 4V, 2V, 0V)

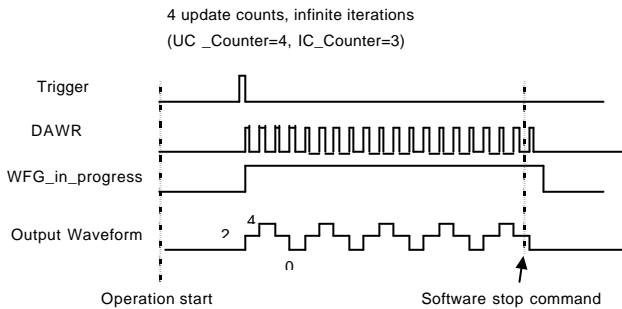

Figure 29: Stop mode II

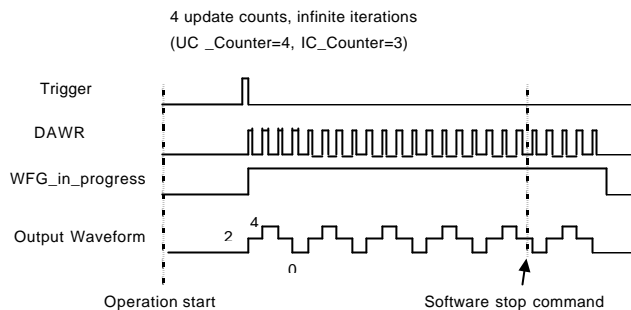

Figure 30: Stop mode III

4.3 Digital I/O

DAQ/PXI-22XX contains 24-lines of general-purpose digital I/O (GPIO), which is provided through a 82C55A chip.

The 24-lines GPIO are separated into three ports: Port A, Port B and Port C. Port A, Port B, Port C high nibble (bit-4 to bit-7), and low nibble (bit 0 to bit 3) can be programmed to be input or output individually. At system startup and reset, all the I/O pins are all reset to be input configuration, that is, high impedance.

DAQ/PXI-2204 also provides 4 digital inputs (SDI from CN2), which are sampled simultaneously with the analog signal input and stored with the 12-bit AD data. Please refer to 4.1.1.1 for the details.

4.4 General Purpose Timer/Counter Operation

Two independent 16-bit up/down timer/counter are designed within FPGA for various applications. They have the following features:

- Count up/down controlled by hardware or software
- Programmable counter clock source (internal or external clock up to 10MHz)
- Programmable gate selection (hardware or software control)
- Programmable input and output signal polarities (high active or low active)
- Initial Count can be loaded from software
- Current count value can be read-back by software without affecting circuit operation

4.4.1 Timer/Counter functions basics

Each timer/counter has three inputs that can be controlled via hardware or software. They are clock input (GPTC_CLK), gate input (GPTC_GATE), and up/down control input (GPTC_UPDOWN). The GPTC_CLK input provides a clock source input to the timer/counter. Active edges on the GPTC_CLK input make the counter increment or decrement. The GPTC_UPDOWN input controls whether the counter counts up or down. The GPTC_GATE input is a control signal which acts as a counter enable or a counter trigger signal under different applications.

The output of timer/counter is GPTC_OUT. After power-up, GPTC_OUT is pulled high by a pulled-up resistor about 10K ohms. Then GPTC_OUT goes low after the DAQ/PXI-22XX initialization.

All the polarities of input/output signals can be programmed by software. In this chapter, for easy explanation, all GPTC_CLK, GPTC_GATE, and GPTC_OUT are assumed to be active high or rising-edge triggered in the figures.

4.4.2 General Purpose Timer/Counter modes

Eight programmable timer/counter modes are provided. All modes start operating following a software-start signal that is set by the software. The GPTC software reset initializes the status of the counter and re-loads the initial value to the counter. The operation remains halted until the software-start is re-executed. The operating theories under different modes are described as below.

4.4.2.1 Mode1: Simple Gated-Event Counting

In this mode, the counter counts the number of pulses on the GPTC_CLK after the software-start. Initial count can be loaded from software. Current count value can be read-back by software any time without affecting the counting. GPTC_GATE is used to enable/disable counting. When GPTC_GATE is inactive, the counter halts the current count value. Figure 31 illustrates the operation with initial count = 5, count-down mode.

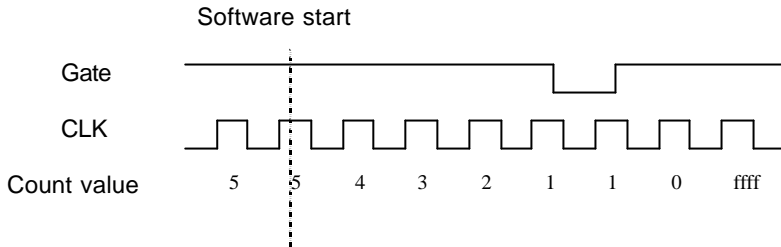

Figure 31: Mode 1 Operation

4.4.2.2 Mode2: Single Period Measurement

In this mode, the counter counts the period of the signal on GPTC_GATE in terms of GPTC_CLK. Initial count can be loaded from software. After the software-start, the counter counts the number of active edges on GPTC_CLK between two active edges of GPTC_GATE. After the completion of the period interval on GPTC_GATE, GPTC_OUT outputs high and then current count value can be read-back by software. Figure 32 illustrates the operation where initial count = 0, count-up mode.

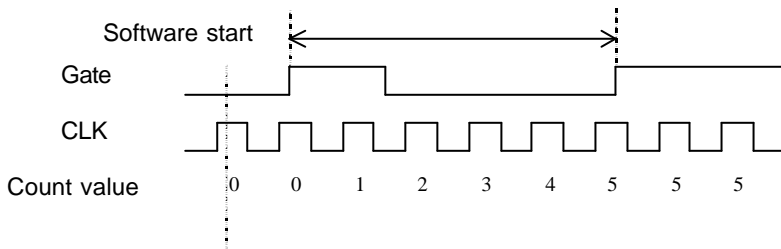

Figure 32: Mode 2 Operation

4.4.2.3 Mode 3: Single Pulse-width Measurement

In this mode the counter counts the pulse-width of the signal on GPTC_GATE in terms of GPTC_CLK. Initial count can be loaded from software. After the software-start, the counter counts the number of active edges on GPTC_CLK when GPTC_GATE is in its active state. After the completion of the pulse-width interval on GPTC_GATE, GPTC_OUT outputs high and then current count value can be read-back by software. Figure 33 illustrates the operation where initial count = 0, count-up mode.

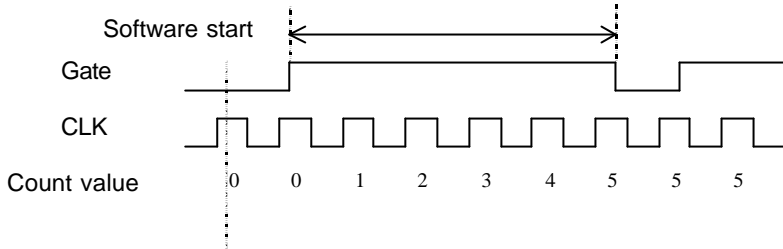

Figure 33: Mode 3 Operation

4.4.2.4 Mode 4: Single Gated Pulse Generation

This mode generates a single pulse with programmable delay and programmable pulse-width following the software-start. The two programmable parameters could be specified in terms of periods of the GPTC_CLK input by software. GPTC_GATE is used to enable/disable counting. When GPTC_GATE is inactive, the counter halts the current count value. Figure 34 illustrates the generation of a single pulse with a pulse delay of two and a pulse-width of four.

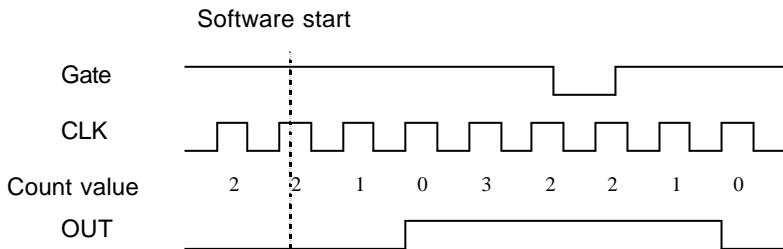

Figure 34: Mode 4 Operation

4.4.2.5 Mode5: Single Triggered Pulse Generation

This function generates a single pulse with programmable delay and programmable pulse-width following an active GPTC_GATE edge. You could specify these programmable parameters in terms of periods of the GPTC_CLK input. Once the first GPTC_GATE edge triggers the single pulse, GPTC_GATE takes no effect until the software-start is re-executed. Figure 35 illustrates the generation of a single pulse with a pulse delay of two and a pulse-width of four.

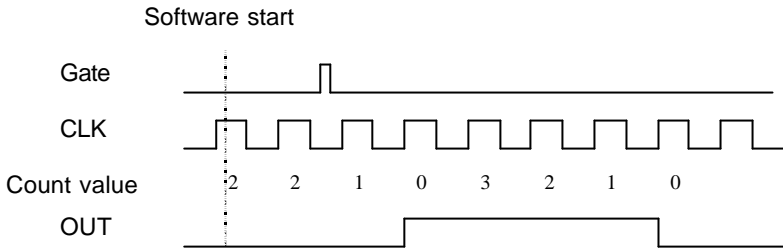

Figure 35: Mode 5 Operation

4.4.2.6 Mode6: Re-triggered Single Pulse Generation

This mode is similar to mode5 except that the counter generates a pulse following every active edge of GPTC_GATE. After the software-start, every active GPTC_GATE edge triggers a single pulse with programmable delay and pulse-width. Any GPTC_GATE triggers that occur when the prior pulse is not completed would be ignored. Figure 36 illustrates the generation of two pulses with a pulse delay of two and a pulse-width of four.

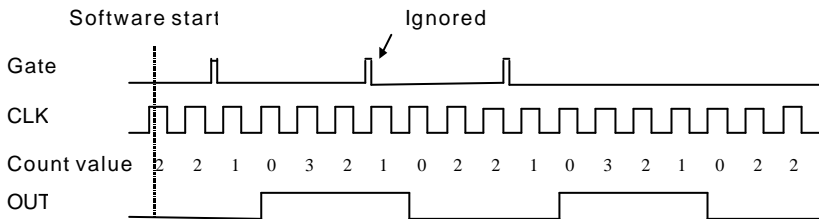

Figure 36: Mode 6 Operation

4.4.2.7 Mode7: Single Triggered Continuous Pulse Generation

This mode is similar to mode5 except that the counter generates continuous periodic pulses with programmable pulse interval and pulse-width following the first active edge of GPTC_GATE. Once the first GPTC_GATE edge triggers the counter, GPTC_GATE takes no effect until the software-start is re-executed. Figure 37 illustrates the generation of two pulses with a pulse delay of four and a pulse-width of three.

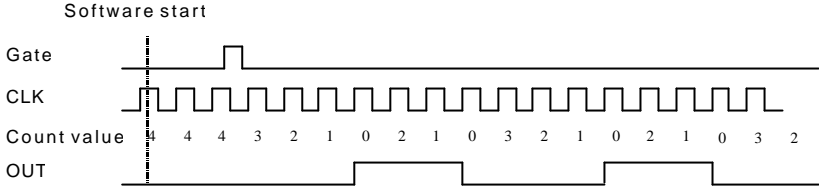

Figure 37: Mode 7 Operation

4.4.2.8 Mode8: Continuous Gated Pulse Generation

This mode generates periodic pulses with programmable pulse interval and pulse-width following the software-start. GPTC_GATE is used to enable/disable counting. When GPTC_GATE is inactive, the counter halts the current count value. Figure 38 illustrates the generation of two pulses with a pulse delay of four and a pulse-width of three.

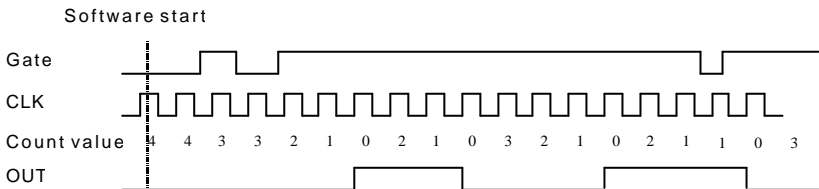

Figure 38: Mode 8 Operation

4.5 Trigger Sources

We provide flexible trigger selections in the DAQ/PXI-22XXseries products. In addition to the internal software trigger, DAQ/PXI-22XX also supports external analog, digital triggers and SSI triggers. Users can configure the trigger source by software for A/D and D/A processes individually. **Note that the A/D and the D/A conversion share the same analog trigger.**

4.5.1 Software-Trigger

This trigger mode does not need any external trigger source. The trigger asserts right after you execute the specified function calls to begin the operation. A/D and D/A processes can receive an individual software trigger.

4.5.2 External Analog Trigger

The analog trigger circuitry routing is shown in the figure 39. The analog multiplexer could select either a direct analog input from the EXTATRIG pin (SRC1 in figure 39) on the 68-pin connector CN1 or the input signal of ADC (SRC2 in figure 39. That is, the first channel input you fill in the Channel Gain Queue). SRC1 can be used for all trigger modes while SRC2 can only be used for post and delay trigger modes. The range of trigger level for SRC1 is $\pm 10\text{V}$ and the resolution is 78mV (please refer to Table 14, the valid code range is from 1 to 255), while the trigger range of SRC2 is the full-scale range of the first channel input in Channel Gain Queue, and the resolution is the desired range divided by 256. For example, if the first channel input in Channel Gain Queue is CH0 with bipolar $\pm 5\text{V}$ range, the trigger voltage would be 4.96V when the trigger level code is set to 0xFF while -4.96V when the code is set to 0x01.

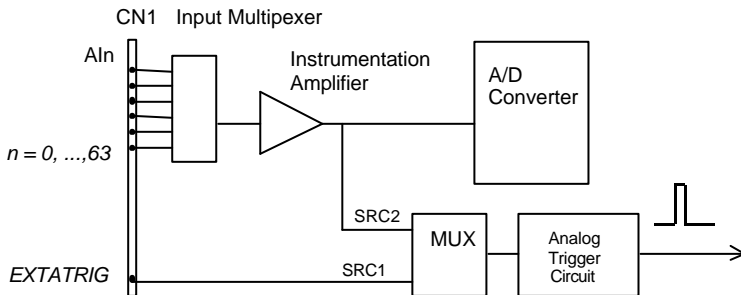

Figure 39: Analog trigger block diagram

Trigger Level digital setting	Trigger voltage
0xFF	9.92V
0xFE	9.84V
---	---
0x81	0.08V
0x80	0
0x7F	-0.08V
---	---
0x01	-9.92V

Table 14: Analog trigger SRC1 (EXTATRIG) ideal transfer characteristic

The trigger signal is generated when the analog trigger condition is satisfied. There are five analog trigger conditions in DAQ/PXI-22XX. DAQ/PXI-22XX uses 2 threshold voltages: Low_Threshold and High_Threshold to build the 5 different trigger conditions. Users could configure the trigger conditions easily by software.

4.5.2.1 *Below-Low analog trigger condition*

Figure 40 shows the below-low analog trigger condition, the trigger signal is generated when the input analog signal is less than the Low_Threshold voltage, and the High_Threshold setting is not used in this trigger condition.

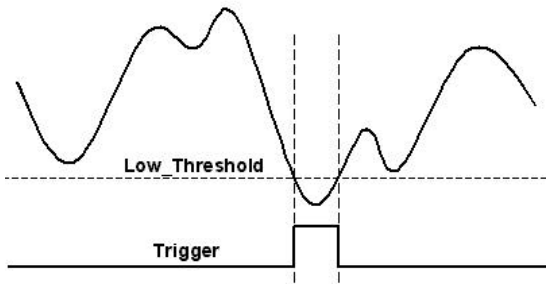

Figure 40: Below-Low analog trigger condition

4.5.2.2 Above-High analog trigger condition

Figure 41 shows the above-high analog trigger condition, the trigger signal is generated when the input analog signal is higher than the High_Threshold voltage, and the Low_Threshold setting is not used in this trigger condition.

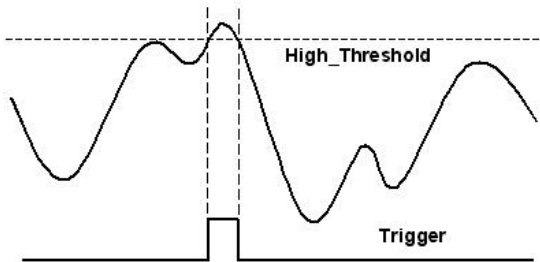

Figure 41: Above-High analog trigger condition

4.5.2.3 Inside-Region analog trigger condition

Figure 42 shows the inside-region analog trigger condition, the trigger signal is generated when the input analog signal level falls in the range between the High_Threshold and the Low_Threshold voltages.

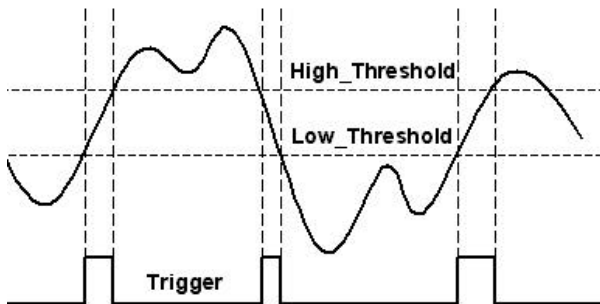

Figure 42: Inside-Region analog trigger condition

4.5.2.4 High-Hysteresis analog trigger condition

Figure 43 shows the high-hysteresis analog trigger condition, the trigger signal is generated when the input analog signal level is greater than the High_Threshold voltage, and the Low_Threshold voltage determines the hysteresis duration.

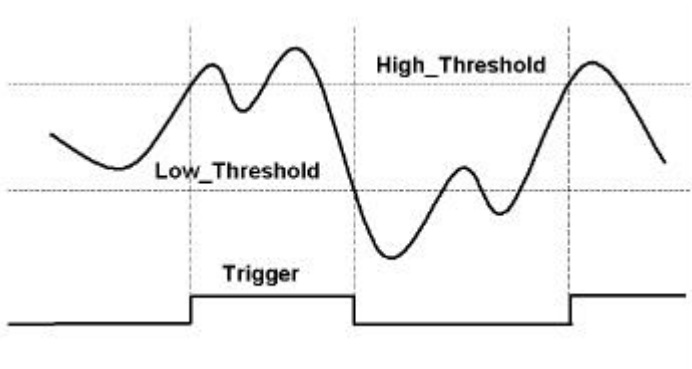

Figure 43: High-Hysteresis analog trigger condition

4.5.2.5 Low-Hysteresis analog trigger condition

Figure 44 shows the low-hysteresis analog trigger condition, the trigger signal is generated when the input analog signal level is less than the Low_Threshold voltage, and the High_Threshold voltage determines the hysteresis duration.

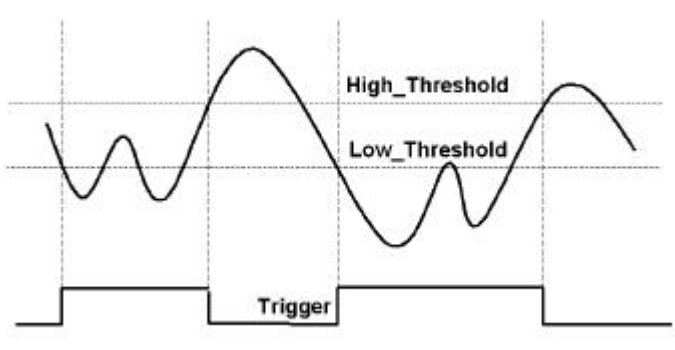

Figure 44: Low-Hysteresis analog trigger condition

4.5.3 External Digital Trigger

An external digital trigger occurs when a rising edge or a falling edge is detected on the digital signal connected to the EXTDRIG or the EXTWFTRG of the 68-pin connector for external digital trigger. The EXTDRIG is dedicated for A/D process, and the EXTWFTRG is used for D/A process. Users can program the trigger polarity through ADLINK's software drivers easily. Note that the signal level of the external digital trigger signals should be TTL-compatible, and the minimum pulse is 20ns.



Figure 45: External digital trigger

4.6 User-controllable Timing Signals

In order to meet the requirements for user-specific timing and the requirements for synchronizing multiple cards, the DAQ/PXI-22XX series provides flexible user-controllable timing signals to connect to external circuitry or additional cards.

The whole DAQ timing of the DAQ/PXI-22XX series is composed of a bunch of counters and trigger signals in the FPGA. These timing signals are related to the A/D, D/A conversions and Timer/Counter applications. These timing signals can be inputs to or outputs from the I/O connectors, the SSI connector and the PXI bus. Therefore the internal timing signals can be used to control external devices or circuitry's.

We implemented signal multiplexers in the FPGA to individually choose the desired timing signals for the DAQ operations, as shown in the figure 46.

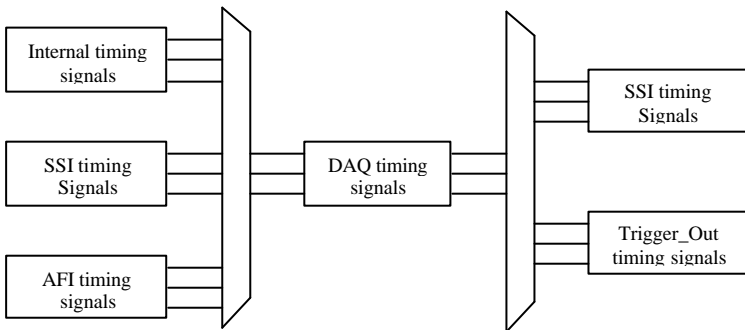

Figure 46: DAQ signals routing

Users can utilize the flexible timing signals through our software drivers, and simply and correctly connect the signals with the DAQ/PXI-22XX series cards. Here is the summary of the DAQ timing signals and the corresponding functionalities for DAQ/PXI-22XX series.

Timing signal category	Corresponding functionality
SSI/PXI signals	Multiple cards synchronization
AFI signals	Control DAQ/PXI-22XX by external timing signals

Figure 47: Summary of user-controllable timing signals and the corresponding functionalities

4.6.1 DAQ timing signals

The user-controllable DAQ timing-signals contains: (Please refer to 4.1.4.1 for the internal timing signal definition)

1. TIMEBASE, providing TIMEBASE for all DAQ operations, which could be from internal 40MHz oscillator, EXTTIMEBASE from I/O connector or the SSI_TIMEBASE. Note that the frequency range of the EXTTIMEBASE is 1MHz to 40MHz, and the EXTTIMEBASE should be TTL-compatible.
2. AD_TRIG, the trigger signal for the A/D operation, which could come from external digital trigger, analog trigger, internal software trigger and SSI_AD_TRIG. Refer to Section 4.5 for detailed description.
3. SCAN_START, the signal to start a scan, which would bring the following ADCONV signals for AD conversion, and could come from the internal SI_counter, AFI[0] and SSI_AD_START. This signal is synchronous to the TIMEBASE. Note that the AFI[0] should be TTL-compatible and the minimum pulse width should be the pulse width of the TIMEBASE to guarantee correct functionalities.
4. ADCONV, the conversion signal to initiate a single conversion, which could be derived from internal counter, AFI[0] or SSI_ADCONV. Note that this signal is edge-sensitive. When using AFI[0] as the external ADCONV source, each **rising edge** of AFI[0] would bring an effective conversion signal. Also note that the AFI[0] signal should be TTL-compatible and the minimum pulse width is 20ns.
5. DA_TRIG, the trigger signal for the D/A operation, which could be derived from external digital trigger, analog trigger, internal software trigger and SSI_AD_TRIG. Refer to Section 4.5 for detailed description.
6. DAWR, the update signal to initiate a single D/A conversion, which could be derived from internal counter, AFI[1] or SSI_DAWR. Note that this signal is edge-sensitive. When using AFI[1] as the external DAWR source, each **rising edge** of AFI[1] would bring an effective update signal. Also note that the AFI[1] signal should be TTL-compatible and the minimum pulse width is 20ns.

4.6.2 Auxiliary Function Inputs (AFI)

Users could use the AFI in applications that take advantage of external circuitry to directly control the DAQ/PXI-22XX cards. The AFI includes 2 categories of timing signals: one group is the dedicated input, and the other is the multi-function input. Table 15 illustrates this categorization.

Summary of the auxiliary function input signals and the corresponding functionalities

Category	Timing signal	Functionality	Constraints
Dedicated input	EXTTIMEBASE	Replace the internal TIMEBASE	<ol style="list-style-type: none"> 1. TTL-compatible 2. 1MHz to 40MHz 3. Affects on both A/D and D/A operations
	EXTDTRIG	External digital trigger input for A/D operation	<ol style="list-style-type: none"> 1. TTL-compatible 2. Minimum pulse width = 20ns 3. Rising edge or falling edge
	EXTWFTRG	External digital trigger input for D/A operation	<ol style="list-style-type: none"> 1. TTL-compatible 2. Minimum pulse width = 20ns 3. Rising edge or falling edge
Multi-function input	AFI[0] (Dual functions)	Replace the internal ADCONV	<ol style="list-style-type: none"> 1. TTL-compatible 2. Minimum pulse width = 20ns 3. Rising-edge sensitive only
		Replace the internal SCAN_START	<ol style="list-style-type: none"> 1. TTL-compatible 2. Minimum Pulse width > 2/TIMEBASE
	AFI[1]	Replace the internal DAWR	<ol style="list-style-type: none"> 1. TTL-compatible 2. Minimum pulse width = 20ns 3. Rising-edge sensitive only

Table 15: Auxiliary function input signals and the corresponding functionalities

EXTDTRIG and EXTWFTRIG

EXTDTRIG and EXTWFTRIG are dedicated digital trigger input signals for A/D and D/A operations respectively. Please refer to section 4.5.3 for detailed descriptions.

EXTTIMEBASE

When the applications needs specific sampling frequency or update rate that the card could not generate from its internal TIMEBASE, the 40MHz clock, users could utilize the EXTTIMEBASE with internal counters to achieve the specific timing intervals for both A/D and D/A operations. Note that once you choose the TIMEBASE source, both A/D and D/A operations will be affected because A/D and D/A operations share the same TIMEBASE

AFI[0]

Alternatively, users can also directly apply an external A/D conversion signal to replace the internal ADCONV signal. This is another way to achieve customized sampling frequencies. The external ADCONV signal can only be inputted from the AFI[0]. As section 4.1 describes, the SI_counter triggers the generation of the A/D conversion signal, ADCONV, but when using the AFI[0] to replace the internal ADCONV signal, then the SI_counter and the internally generated SCAN_START will not be effective. By controlling the ADCONV externally, users can sample the data according to external events. In this mode, the Trigger signal and trigger mode settings will are not available.

AFI[0] could also be used as SCAN_START signal for A/D operations. Please refer to sections 4.1 and 4.6.1 for detailed descriptions of the SCAN_START signal. When using external signal (AFI[0]) to replace the internal SCAN_START signal, the pulse width of the AFI[0] must be greater than two time of the period of Timebase. This feature is suitable for the DAQ-2200/PXI-2200 series, which can scan multiple channels data controlled by an external event. Note that the AFI[0] is a multi-purpose input, and it can only be utilized for one function at any one time.

AFI[1]

Regarding the D/A operations, users could directly input the external D/A update signal to replace the internal DAWR signal. This is another way to achieve customized D/A update rates. The external DAWR signal can only be inputted from the AFI[1]. Note that the AFI[1] is a multi-purpose input, and it can only be utilized for one function at any one time. AFI[1] currently only has one function. ADLINK reserves it for future development.

4.6.3 System Synchronization Interface

SSI (System Synchronization Interface) provides the DAQ timing synchronization between multiple cards. In DAQ/PXI-22XX series, we designed a bi-directional SSI I/O to provide flexible connection between cards and allow one SSI master to output the signal and up to three slaves to receive the SSI signal. Note that the SSI signals are designed for card synchronization only, not for external devices.

SSI timing signal	Functionality
SSI_TIMEBASE	SSI master: send the TIMEBASE out SSI slave: accept the SSI_TIMEBASE to replace the internal TIMEBASE signal. Note: Affects on both A/D and D/A operations
SSI_AD_TRIG	SSI master: send the internal AD_TRIG out SSI slave: accept the SSI_AD_TRIG as the digital trigger signal.
SSI_ADCONV	SSI master: send the ADCONV out SSI slave: accept the SSI_ADCONV to replace the internal ADCONV signal.
SSI_SCAN_START	SSI master: send the SCAN_START out SSI slave: accept the SSI_SCAN_START to replace the internal SCAN_START signal.
SSI_DA_TRIG	SSI master: send the DA_TRIG out. SSI slave: accept the SSI_DA_TRIG as the digital trigger signal.
SSI_DAWR	SSI master: send the DAWR out. SSI slave: accept the SSI_DAWR to replace the internal DAWR signal.

Table 16: Summary of SSI timing signals and the corresponding functionalities as the master or slave

In PCI form factor, there is a connector on the top right corner of the card for the SSI. Refer to section 2.3 for the connector position. All the SSI signals are routed to the 20-pin connector from the FPGA. To synchronize multiple cards, users can connect a special ribbon cable (ACL-SSI) to all the cards in a daisy-chain configuration

In PXI form factor, we utilize the PXI trigger bus built on the PXI backplane to provide the necessary timing signal connections. All the SSI signals are routed to the P2 connector. No additional cable is needed. For detailed information of the PXI specifications, please refer to PXI specification Revision 2.0 from PXI System Alliance (www.pxisa.org).

The 6 internal timing signals could be routed to the SSI or the PXI trigger bus through software drivers. Please refer to section 4.6.1 for detailed information of the 6 internal timing signals. Physically the signal routings are accomplished in the FPGA. Cards that are connected together through the SSI or the PXI trigger bus, will still achieve synchronization on the 6 timing signals.

The mechanism of the SSI/PXI

1. 1. We adopt master-slave configuration for SSI/PXI. In a system, for each timing signal, there shall be only one master, and other cards are SSI slaves or with the SSI function disabled.
2. For each timing signal, the SSI master doesn't have to be in a single card.

For example:

We want to synchronize the A/D operation through the ADCONV signal for 4 DAQ/PXI-22XX cards. Card 1 is the master, and Card 2, 3, 4 are slaves. Card 1 receives an external digital trigger to start the post trigger mode acquisition. The SSI setting could be:

- a. Set the SSI_ADCONV signal of Card 1 to be the master.
- b. Set the SSI_ADCONV signals of Card 2, 3, 4 to be the slaves.
- c. Set external digital trigger for Card 1's A/D operation.
- d. Set SI_counter, SI2_counter, NumChan_counter and the post scan counter (PSC) on all other cards.
- e. Start DMA operations for all cards, thus all the cards are waiting for the trigger event.

When the digital trigger condition of Card 1 occurs, Card 1 will internally generate the ADCONV signal and output this ADCONV signal to SSI_ADCONV signal of Card 2, 3 and 4 through the SSI/PXI connectors. Thus we can achieve 16-channel acquisition simultaneously.

You could arbitrarily choose each of the 6 timing signals as the SSI master from any one of the cards. The SSI master can output the internal timing signals to the SSI slaves. With the SSI, users could achieve better card-to-card synchronization.

Note that when power-up or reset, the DAQ timing signals are reset to use the internal generated timing signals.

5

Calibration

This chapter introduces the calibration process to minimize AD measurement errors and DA output errors.

5.1 Loading Calibration Constants

The DAQ/PXI-22XX is factory calibrated before shipment by writing the associated calibration constants of TrimDACs to the on-board EEPROM. TrimDACs are devices containing multiple DACs within a single package. TrimDACs do not have memory capability. That means the calibration constants do not retain their values after the system power is turned off. Loading calibration constants is the process of loading the values of TrimDACs stored in the on-board EEPROM. ADLINK provides software to make it easy to read the calibration constants automatically when necessary.

There is a dedicated space for calibration constants in the EEPROM. In addition to the default bank of factory calibration constants, there are three extra user-modifiable banks. This means users can load the TrimDACs values either from the original factory calibration or from a calibration that is subsequently performed.

Because of the fact that errors in measurements and outputs will vary with time and temperature, it is recommended re-calibration when the card is installed in the users environment. The auto-calibration function used to minimize errors will be introduced in the next sub-section.

5.2 Auto-calibration

By using the auto-calibration feature of the DAQ/PXI-22XX, the calibration software can measure and correct almost all the calibration errors without any external signal connections, reference voltages, or measurement devices.

The DAQ/PXI-22XX has an on-board calibration reference to ensure the accuracy of auto-calibration. The reference voltage is measured at the factory and adjusted through a digital potentiometer by using an ultra-precision calibrator. The impedance of the digital potentiometer is memorized after this adjustment. It is not recommended for users to adjust the on-board calibration reference except when an ultra-precision calibrator is available.

Note:

1. Before auto-calibration procedure starts, it is recommended to warm up the card for at least 15 minutes.
 2. Please remove the cable before an auto-calibration procedure is initiated because the DA outputs would be changed in the process of calibration.
-

5.3 Saving Calibration Constants

After an auto-calibration is completed, users can save the new calibration constants into one of the three user-modifiable banks in the EEPROM. The date and the temperature when you ran the auto-calibration will be saved accompanied with the calibration constants. This means users can store three sets of calibration constants according to three different environments and re-load the calibration constants later.

Warranty Policy

Thank you for choosing ADLINK. To understand your rights and enjoy all the after-sales services we offer, please read the following carefully.

1. Before using ADLINK's products, please read the user manual and follow the instructions exactly. When sending in damaged products for repair, please attach an RMA application form.
2. All ADLINK products come with a two-year guarantee, free of repair charge.
 - The warranty period starts from the product's shipment date from ADLINK's factory
 - Peripherals and third-party products not manufactured by ADLINK will be covered by the original manufacturers' warranty
 - End users requiring maintenance services should contact their local dealers. Local warranty conditions will depend on the local dealers
3. Our repair service does not cover the two-year warranty, if the following items cause damages:
 - a. Damage caused by not following instructions on user menus.
 - b. Damage caused by carelessness on the users' part during product transportation.
 - c. Damage caused by fire, earthquakes, floods, lightening, pollution and incorrect usage of voltage transformers.
 - d. Damage caused by unsuitable storage environments with high temperatures, high humidity or volatile chemicals.
 - e. Damage caused by leakage of battery fluid when changing batteries.
 - f. Damages from improper repair by unauthorized technicians.
 - g. Products with altered and damaged serial numbers are not entitled to our service.
 - h. Other categories not protected under our guarantees.
4. Customers are responsible for the fees regarding transportation of damaged products to our company or to the sales office.

5. To ensure the speed and quality of product repair, please download an RMA application form from our company website www.adlinktech.com. Damaged products with RMA forms attached receive priority.

For further questions, please contact our FAE staff.

ADLINK: service@adlinktech.com

Test & Measurement Product Segment: NuDAQ@adlinktech.com

Automation Product Segment: Automation@adlinktech.com

Computer & Communication Product Segment: NuPRO@adlinktech.com ;
NuIPC@adlinktech.com