

Total solder points: 338
Difficulty level: *beginner* 1 2 3 4 5 *advanced*

Remote control by telephone

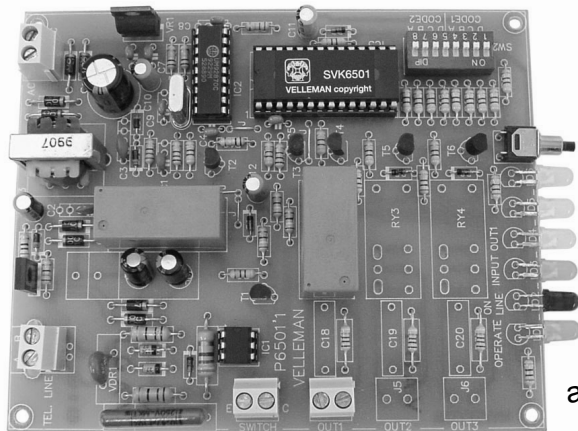

K6501

Operate your appliances from
anywhere with a simple phone call.

Features:

- ☑ Controlled from a touch tone phone (DTMF).
- ☑ Unit gives audible feedback of output status.
- ☑ Adjustable security code.
- ☑ Pickup after 4 or 7 rings possible.
- ☑ Room for three output relays, one relay included.
- ☑ Input to monitor the status of a switch from a distance.

Specifications:

- Relay outputs : 240V/5A
- Power supply : 12VAC or DC / 300mA.
- Dimensions : 105x130

1. Assembly (Skipping this can lead to troubles !)

Ok, so we have your attention. These hints will help you to make this project successful. Read them carefully.

1.1 Make sure you have the right tools:

- A good quality soldering iron (25-40W) with a small tip.
- Wipe it often on a wet sponge or cloth, to keep it clean; then apply solder to the tip, to give it a wet look. This is called 'thinning' and will protect the tip, and enables you to make good connections. When solder rolls off the tip, it needs cleaning.
- Thin raisin-core solder. Do not use any flux or grease.
- A diagonal cutter to trim excess wires. To avoid injury when cutting excess leads, hold the lead so they cannot fly towards the eyes.
- Needle nose pliers, for bending leads, or to hold components in place.
- Small blade and Phillips screwdrivers. A basic range is fine.

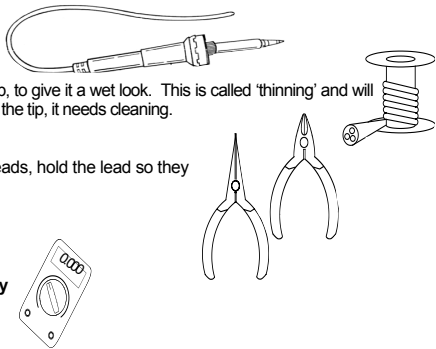

For some projects, a basic multi-meter is required, or might be handy

1.2 Assembly Hints :

- ⇒ Make sure the skill level matches your experience, to avoid disappointments.
- ⇒ Follow the instructions carefully. Read and understand the entire step before you perform each operation.
- ⇒ Perform the assembly in the correct order as stated in this manual
- ⇒ Position all parts on the PCB (Printed Circuit Board) as shown on the drawings.
- ⇒ Values on the circuit diagram are subject to changes.
- ⇒ Values in this assembly guide are correct*
- ⇒ Use the check-boxes to mark your progress.
- ⇒ Please read the included information on safety and customer service

* Typographical inaccuracies excluded. Always look for possible last minute manual updates, indicated as 'NOTE' on a separate leaflet.

1.3 Soldering Hints :

1- Mount the component against the PCB surface and carefully solder the leads

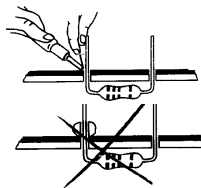

2- Make sure the solder joints are cone-shaped and shiny

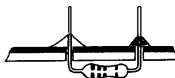

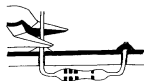

3- Trim excess leads as close as possible to the solder joint

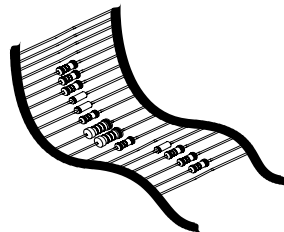

REMOVE THEM FROM THE TAPE ONE AT A TIME !

AXIAL COMPONENTS ARE TAPED IN THE CORRECT MOUNTING SEQUENCE !



 You will find the colour code for the resistances and the LEDs in the HALG (general manual) and on our website: <http://www.velleman.be/common/service.aspx>

1. Jumpers

J : 5x

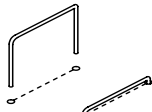

2. Diodes. Watch the polarity!

D1 : 1N4148
 D2 : 1N4148
 D3 : 1N4148
 D4 : 1N4148
 D5 : 1N4148
 D6 : 1N4148

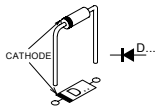

D7 : 1N4007
 D8 : 1N4007
 D9 : 1N4007
 D10 : 1N4007
 D11 : 1N4007
 D12 : 1N4007
 D13 : 1N4007
 D14 : 1N4007



3. Zenerdiodes. Watch the polarity!

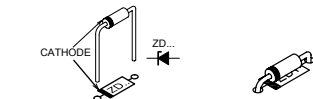

ZD1 : 4V7 (4,7V)
 ZD2 : 4V7 (4,7V)
 ZD3 : 4V7 (4,7V)
 ZD4 : 27V0
 ZD5 : 27V0

4. 1/4W Resistors

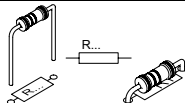

R1 : 560 (5 - 6 - 1 - B)
 R2 : 100 (1 - 0 - 1 - B)
 R3 : 4K7 (4 - 7 - 2 - B)
 R4 : 4K7 (4 - 7 - 2 - B)
 R5 : 4K7 (4 - 7 - 2 - B)
 R6 : 4K7 (4 - 7 - 2 - B)
 R7 : 4K7 (4 - 7 - 2 - B)

R8 : 4K7 (4 - 7 - 2 - B)
 R9 : 4K7 (4 - 7 - 2 - B)
 R10 : 4K7 (4 - 7 - 2 - B)
 R11 : 4K7 (4 - 7 - 2 - B)
 R12 : 4K7 (4 - 7 - 2 - B)
 R13 : 4K7 (4 - 7 - 2 - B)
 R14 : 4K7 (4 - 7 - 2 - B)
 R15 : 4K7 (4 - 7 - 2 - B)
 R16 : 4K7 (4 - 7 - 2 - B)
 R17 : 4K7 (4 - 7 - 2 - B)
 R18 : 4K7 (4 - 7 - 2 - B)
 R19 : 100K (1 - 0 - 4 - B)
 R20 : 100K (1 - 0 - 4 - B)
 R21 : 100K (1 - 0 - 4 - B)
 R22 : 330K (3 - 3 - 4 - B)
 R23 : 390 (3 - 9 - 1 - B)
 R24 : 390 (3 - 9 - 1 - B)
 R25 : 390 (3 - 9 - 1 - B)
 R26 : 820 (8 - 2 - 1 - B)
 R27 : 820 (8 - 2 - 1 - B)
 R28 : 820 (8 - 2 - 1 - B)
 R29 : 820 (8 - 2 - 1 - B)
 R30 : 2K2 (2 - 2 - 2 - B)
 R31 : 82 (8 - 2 - 0 - B)
 R32 : 6K8 (6 - 8 - 2 - B)

5. 1/2W Resistors

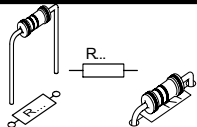

- R33 : 22 (2 - 2 - 0 - B - 9)
- R34 : 22 (2 - 2 - 0 - B - 9)
- R35 : 220 (2 - 2 - 1 - B - 9)
- R36 : 220 (2 - 2 - 1 - B - 9)
- R37 : 220 (2 - 2 - 1 - B - 9)

6. 1W Resistor

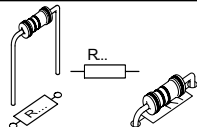

- R38 : 5K6 (5 - 6 - 2 - B)

7. Capacitors

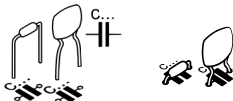

- C1 : 4n7 (472)
- C2 : 22nF (223)
- C3 : 33nF (333)
- C4 : 100nF (104)
- C5 : 100nF (104)
- C6 : 100nF (104)
- C7 : 100nF (104)
- C8 : 100nF (104)
- C9 : 100nF (104)

8. IC sockets, Watch the position of the notch!

- IC1 : 6p
- IC2 : 18p
- IC3 : 28p

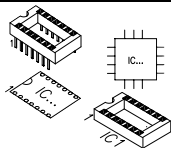

9. LEDs. Watch the polarity !

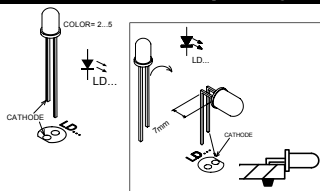

First : Bend the leads exactly like the drawing.

Next : Solder **one** lead, and check the position, if necessary correct by heating the soldering.

Last : Solder the second connection.

- LD1 : 5mm green
- LD2 : 5mm red
- LD3 : 5mm green
- LD4 : 5mm yellow
- LD5 : 5mm yellow
- LD6 : 5mm yellow

Pay attention to the polarity of LD1!

10. Push button

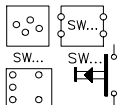

- SW1 : 1 pos.

11. Transistors

- T1 : BC547B
- T2 : BC547B
- T3 : BC547B
- T4 : BC547B
- T5 : BC547B
- T6 : BC547B

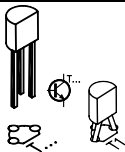

13. VDR



- VDR1

14. Electrolytic capacitors. Watch the polarity !

- C10 : 1 μ F
- C11 : 1 μ F
- C12 : 1 μ F
- C13 : 1 μ F
- C14 : 10 μ F
- C15 : 10 μ F

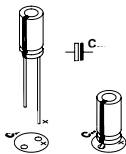

12. Quartz crystal

- X1 : 3,5795MHz

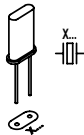

15. Power transistor

- T7 : BD681

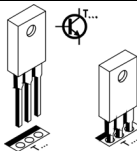

16. Screw connectors

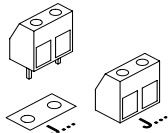

- J1 : 2p
- J2 : 2p
- J3 : 2p
- J4 : 2p

17. Isolation transformer

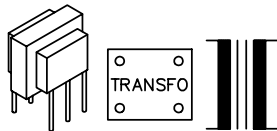

- TRAF01 : TRS1/1 (600/600)

18. Electrolytic capacitor. Watch the polarity !

- C16 : 470 μ F

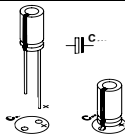

19. Capacitor

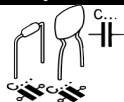

- C17 : 0.47 μ F / 250V

20. Voltage regulator

- VR1 : UA7805

☞ Check the orientation !

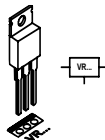

21. Relays

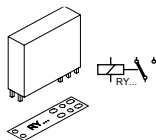

- RY1 : VR10V121C (1p/12VDC)
- RY2 : VR10V121C (1p/12VDC)

22. IC mounting

- IC1 : 4N35
- IC2 : HT9170
- IC3 : VK6501

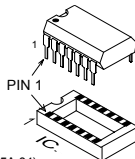

VK6501=(Programmed PIC16C55A-04)

☞ Pay attention to the position
of the notch!

23. Connection

1. Connect the telephone connections 'A' and 'B' to the telephone line connections 'a' and 'b'.
2. Connect a transformer or adapter of 12VAC min. 300mA to the AC connections.
3. If required, connect the switching outputs to the devices. The three outputs between L and P are normally open contacts
4. If you want to check the condition of a (dead) switch, it may be connected between the SW terminals. If the switch is closed, the green IN LED will light up.

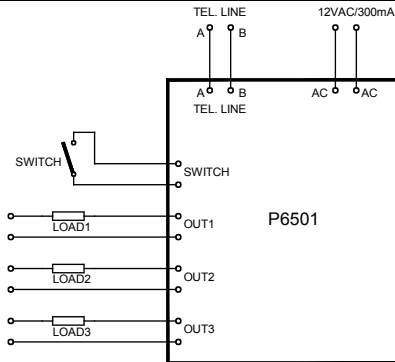





















24. Manual operation

1. The three outputs may be turned on or off manually by means of the push button. If the output is on (contact closed) the corresponding LED will light up.
2. Press the push button once to turn output 1 on or off.
3. Press the push button twice shortly after one another to turn output 2 on or off.
4. Press the push button three times shortly after one another to turn output 3 on or off.

25. Setting the code

See table to set the first digit (CODE1 or decades) and the second digit (CODE2 or units).

0	SW2  D C B A CODE1	SW2  D C B A CODE2	0
1			1
2			2
3			3
4			4
5			5
6			6
7			7
8			8
9			9

26. Setting the number of rings

Normally the device is set to pick up the phone after ± 8 rings. If, however, you would like the device to pick up the phone sooner (after ± 3 rings), the manual operating push button should be held pressed before switching on the power supply. Output 1 will switch on by way of confirmation.

27. Use

ESTABLISHING THE CONNECTION:

1. Call the phone number to which the remote control is connected.
2. After about 3 or 8 rings the remote control will answer. The red "ON LINE" LED on the device will flash.
3. A few seconds after picking up you will hear the condition of the outputs. First the switch input, then output 1, output 2, and output 3 in that order. A double tone indicates that the condition is ON, whereas a single tone indicates that the condition is OFF.

RETRIEVING INFORMATION FROM OUTPUTS OR INPUT:

Enter: code1, code2 and then 0 0. Now you will once again hear the condition of the input and of the outputs. This procedure may be repeated as often as you like.

SWITCHING A PARTICULAR OUTPUT ON:

Enter: code1, code2, output number, **1**. After a few seconds you will hear the condition of the input and of the outputs.

Example: Suppose you want to switch output 2 on and that your code is 43. Enter the following digits: 4-3-2-1.

SWITCHING A PARTICULAR OUTPUT OFF:

Enter: code1, code2, output number, **0**. The condition of the input and of the outputs will be repeated immediately.

Example: Suppose you want to switch output 2 off and that your code is 43. Enter the following digits: 4-3-2-0.



NOTES:

- If you do not press a button within 20 seconds, the connection will be terminated automatically.
- If you enter a wrong code, you will hear an alarm tone. After that, you still have two chances to enter the correct code. If the correct code has not been entered after three attempts, the device will terminate the connection.

29. Schematic diagram.

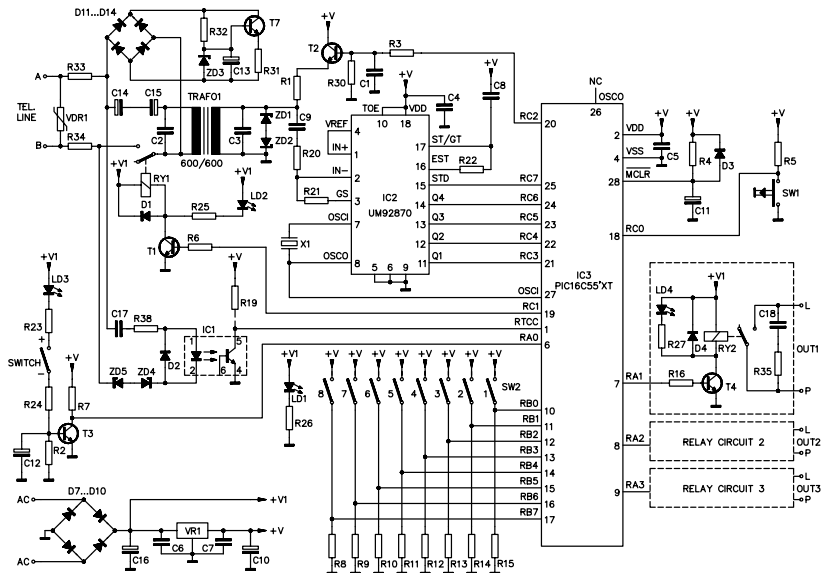

30. PCB

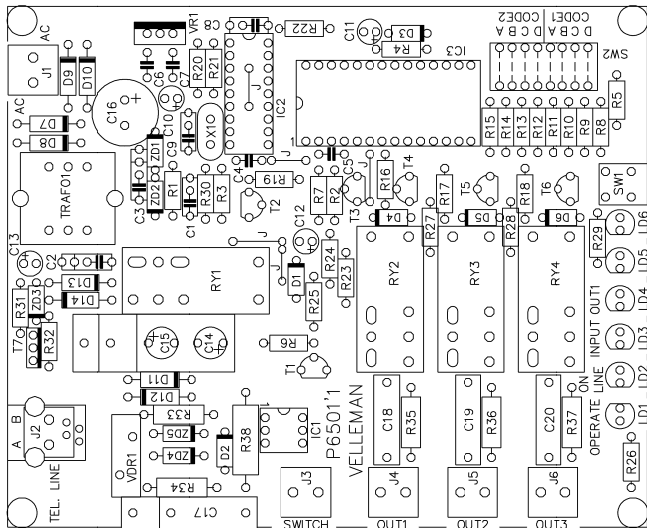

VELBUS
Velleman Home Automation System

VELBUS
Velleman Home Automation System

All appliances get intelligent, how about your home?
see our website : www.velbus.be

Modifications and typographical errors reserved
 © Velleman nv.
 H65011P - 2004 - ED1_rev.2

VELLEMAN NV
Legen Heirweg 33, 9890 Gavere
Belgium - Europe

