

K181. A ROLLING CODE 10-CHANNEL UHF REMOTE CONTROL

This kit is based on a kit published in the Australian electronics magazine *Silicon Chip* in 7/2002. It was a Rolling Code 4-Channel UHF Remote Control. We suggest you download the article from <http://www.crowcroft.net/kitsrus/k180.pdf>

since it fully discusses what Rolling Code is and explains the operation of the Kit which we have not repeated here. In that kit each of the 4 buttons controlled a relay and whether the action was momentary or toggle was jumper selectable. However, if you refer to the technical details about the Automicro devices which can be got from <http://www.kitsrus.com/pdf/automicro.pdf>

you will see that 10 keypress combinations are actually supported – the 4 single buttons and 6 two-keypress combinations. This kit takes uses all 10 keypress combinations to operate 10 relays. The 12V relays can switch 120VAC at 1 Amp. You can view the Data Sheet for the relays at http://www.kitsrus.com/pdf/az_relay.pdf

A preprogrammed PIC16F628-04/P is used to do all the keypress decoding and relay activation. You may download the sourcecode from http://www.kitsrus.com/zip/k181_sourcecode.zip

The kit starts in momentary mode for all relays – that is, the relay only operates when the button is depressed. However, if you keep the button or keypress combination depressed for more than two seconds you go to toggle mode for that particular relay. The **MODE LED** will come on after the 2 seconds to indicate that the mode has changed.

Up to 15 Transmitter units can be learnt by one Rx unit. Press button 1 (the button all by itself) while simultaneously pressing the **LEARN** tact switch on the main board. You only have to do this briefly for under a second. But note it takes about **15 seconds** for the two units to internally connect and recognize each other. (During this 15 seconds it seems that one and only one keypress of the Tx unit will be recognised. Just disregard this. Wait the full 15 seconds until the two units have connected. Do not press the LEARN button again. Just wait 15 seconds.)

Tx units attached to any Rx unit can be unattached by pressing the **LEARN** button continuously for 8 seconds. The **IND** LED, L11, is on during these 8 seconds. As soon as this LED goes off then you know that all Tx units previously recognized by the Rx unit have now been unattached from the Rx unit.

If you want more details about the Microchip technology behind these Tx & Rx's then get

<http://www.kitsrus.com/pdf/an662.pdf> and <http://www.kitsrus.com/pdf/an665.pdf>

We sell Tx units and Rx units separately as A16TX and A16RX.

Assembly. See **Parts List** below. We have supplied 30 pins for the Common, Normally Open (NO), and Normally Closed (NC) pads from the 10 relays. However, you may add your own terminal blocks here if you wish. We have designed for both. Follow the overlay for component placement. Solder the lowest height components first – the resistors and diodes. Make sure to get the diodes and electrolytic capacitors around the right way. We have supplied green LEDs for L11 and L12.

Email me at peter@kitsrus.com if you have any questions.

Also see Kit 157, our 2-Channel Rolling Code UHF Remote Control.

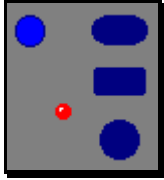

Relay #1

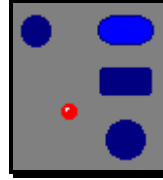

Relay #2

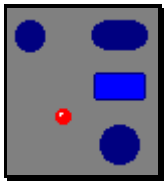

Relay #3

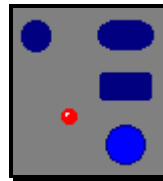

Relay #4

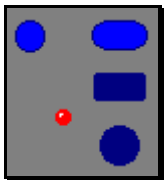

Relay #5

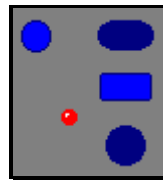

Relay #6

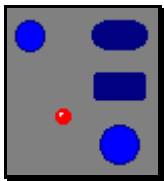

Relay #7

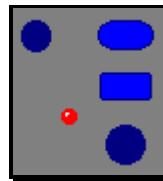

Relay #8

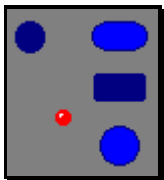

Relay #9

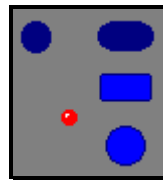

Relay #10

Button Positions

K181. A ROLLING CODE 10-CHANNEL UHF REMOTE CONTROL

COMPONENTS

Resistors 5%, 1/4W:	
1K R21	1
1N4004 D1 to 11	11
2K2 R1 to 10, R22	11
4K7 R11 to 20	10
PINS	30
100n box poly C3, C4	2
100uF/16V C1 C2	2
7805 U1	1
BC548B TR1 to 10	10
LED green 5mm L11, L12	2
LED red 5mm L1 to L10	10
ZIPPY switch SW1	1
Power jack	1
16F628 U2	1
18 pin IC socket	1
Antenna 17 cm hookup wire	1
AZ-SH-112L relays	10
K181 PCB	1
4 button TX-4312RSA(A1)	1
RX-3302D4-15(2A1)	1

Button 1 (small one)	Relay 1
Button 2	Relay 2
Button 3	Relay 3
Button 4	Relay 4
Buttons 1 & 2	Relay 5
Buttons 1 & 3	Relay 6
Buttons 1 & 4	Relay 7
Buttons 2 & 3	Relay 8
Buttons 2 & 4	Relay 9
Buttons 3 & 4	Relay 10

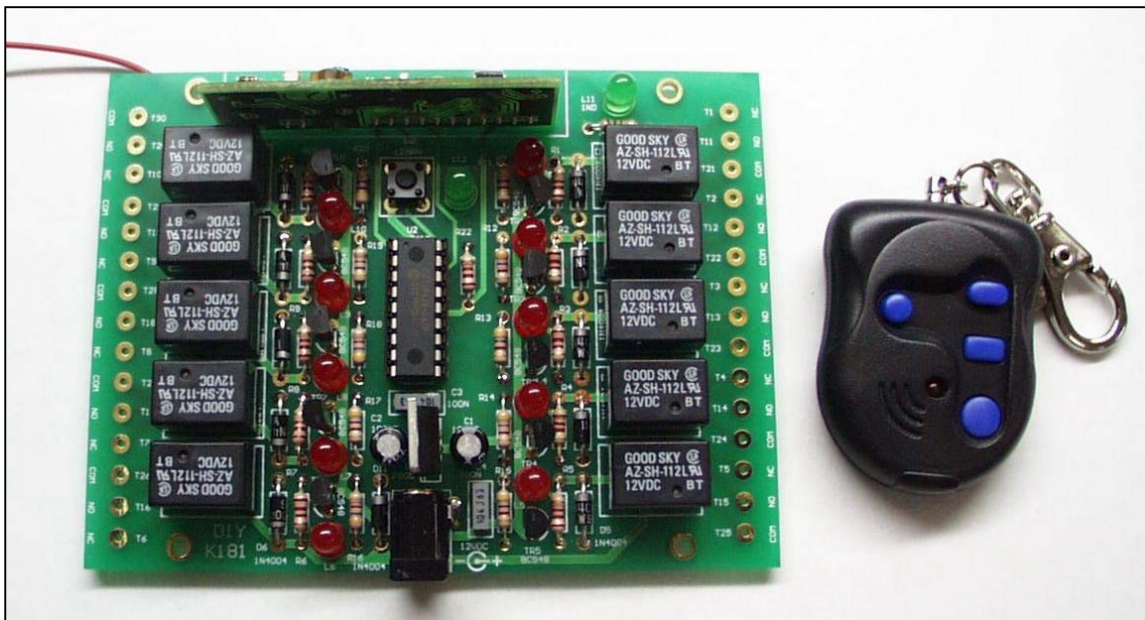

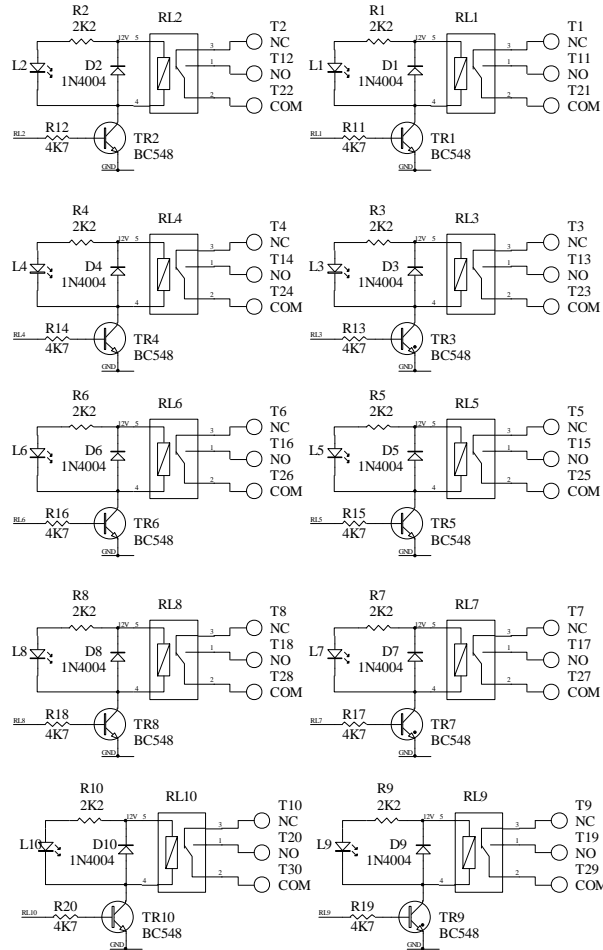
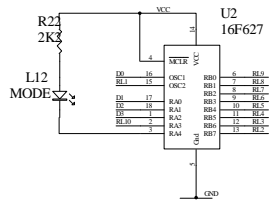
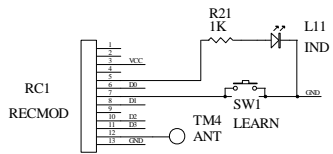
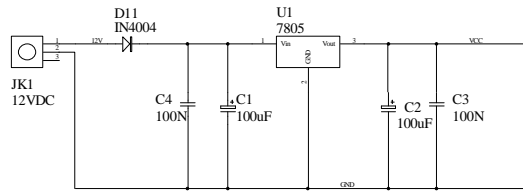

Title		
Rev	Number	Revision
C		
Drawn	27-Nov-2010	Sheet of
Disc	PROJECT/PEPPER/ALU/EXAM01.SCH	Drawn By