

NETWORK MULTIMETER



user manual

HYS006113



CONTENTS

1. SAFETY INFORMATION1
1.1 Preliminary1
1.2 Dos and don'ts2
1.3 Symbols3
1.4 Precautions4
2. DESCRIPTION5
2.1 Names of parts6
2.2 Switches, buttons and input jacks7
2.3 Display8
3. SPECIFICATIONS10
3.1 General10
3.2 Technical index11
4. OPERATING INSTRUCTIONS14
4.1 Function switching14
4.2 Range switching15
4.3 Maximum value measurement15
4.4 Reading holding15
4.5 Backlight source16
4.6 Use of the test key16
4.7 Preparation for measurement16
4.8 Measurement of DC voltage17

4.9	Measurement of AC voltage18
4.10	Diode test19
4.11	Circuit continuity test20
4.12	Resistance measurement21
4.13	Measurement of DC current22
4.14	Measurement of AC current23
4.15	Phone line mode detection24
4.16	Judgment and tracking of cable line26
4.17	Network cable integrity test28
4.18	Non-contact voltage detection31
4.19	Operating precautions of protective cover32
4.20	Automatic power off33
5.	MAINTENANCE33
5.1	Replacement of batteries33
5.2	Replacement of fuse34
5.3	Replacement of test probes35
6.	ACCESSORIES36

1. SAFETY INFORMATION**Warning**

BE EXTREMELY CAREFUL WHEN USING THE METER.
Improper use of this device can result in electric shock or destruction of the meter. Take all normal safety precautions and follow the safeguards suggested in this manual.

To exploit full functionality of the meter and ensure safe operation, Protection provided by the instrument will be impaired if used in a manner not specified by the manufacturer.

The Auto Range Digital Multimeter (hereinafter referred to as "the meter") complies with the safety requirements for electronic measuring instruments in IEC-61010-1, falls into pollution degree 2 and meets the over-voltage standard of CAT III 600V.

Follow all safety and operation instructions to ensure safe use of the meter.

With proper use and care, the meter will give you years of satisfactory service.

1.1 Preliminary

1.1.1 To operate the meter, the user must observe the following normal safety rules:

- 1) General protection against electric shock; and
- 2) Protection of the meter against misuse

- 1.1.2 When the meter is received, please check whether it has been damaged during transport.
- 1.1.3 After being stored and delivered under harsh conditions, the meter should be checked and confirmed for damage.
- 1.1.4 The test probes must be kept in good condition. Check whether the insulation of the test probes has been damaged and whether any wire has been exposed.
- 1.1.5 Using the test probes supplied can ensure safety. If required, they must be replaced with those of the same model or class.

1.2 Dos and don'ts

- 1.2.1 Use the right input jack, function and range.
- 1.2.2 Do not take measurements beyond the protection limits indicated in the specifications.
- 1.2.3 Do not touch the metal tips of the test probes when connecting the meter to the circuit to be measured.
- 1.2.4 Keep your fingers behind the probe barriers when taking a measurement with an effective voltage of above 60V DC or 30V AC.
- 1.2.5 Do not take any voltage measurement if the value between the measuring terminal and the ground exceeds 1000V.

- 1.2.6 Select the highest range if the value to be measured in the manual range is unknown.
- 1.2.7 Do not connect the meter to any voltage source while the meter is in the current, resistance, diode or continuity test range.
- 1.2.8 Disconnect the test probes from the circuit under test before turning the range selector to change functions.
- 1.2.9 Be careful that high voltage pulses at the test point may damage the meter when measurements are being taken on the switching power circuit of a TV set.
- 1.2.10 Do not measure the resistance, diode or continuity of live circuits.
- 1.2.11 Do not use the meter near explosive gases, steam or dirt.
- 1.2.12 Stop using the meter if any abnormalities or faults are noticed.
- 1.2.13 Do not use the meter unless its rear case is securely fastened in its original position.
- 1.2.14 Do not store or use the meter in areas exposed to direct sunlight, high temperatures or high humidity.

1.3 Symbols



Important safety information; refer to the operation manual.

 Dangerous voltage may be present.

 Double insulation (protection class II)

CAT III – over-voltage (installation) category III, pollution degree 2 per IEC61010-1, referring to the level of impulse withstand voltage protection provided.

 Compliance with European Union (EU) directives

 Ground

 Fuse

1.4 Precautions

- 1.4.1 Do not adjust or repair the meter by attempting to remove the rear case. Such operation should only be performed by a technician who fully understands the meter and the electric shock risk involved.
- 1.4.2 Remove the test probes from the circuit under test before opening the battery cover of the meter.
- 1.4.3 To avoid any electric shock caused by erroneous readings, replace the batteries immediately when the  symbol appears on the LCD.
- 1.4.4 To avoid fire hazards, the replacement fuse must meet the specified voltage and current ratings of F 10A/500V and F200mA/1000V (quick acting).
- 1.4.5 Use wet cloth and mild detergent to clean the meter; do not use abrasives or solvents.
- 1.4.6 Turn to OFF switch off the power when is not in use.

- 1.4.7 Remove the batteries to avoid damages to the meter if it will idle for a long time.
- 1.4.8 Using this appliance in an environment with a strong radiated radio-frequency electromagnetic field (approximately 3V/m), may influence its measuring accuracy. The measuring result can be strongly deviating from the actual value.

2. DESCRIPTION

- The meter is a portable specialized measuring instrument with a large digital LCD, as well as a backlight source for easy reading. The range selector designed for single-hand operation makes measurement easy. Overload protection and low battery indication are provided. It is an ideal multi-functional instrument with scores of practical applications for professional, factory, school, amateur and home use.
- The meter can be used to measure DC and AC voltages and currents, and resistances, test circuit continuity and diodes, detect phone line mode, judge break points in cable lines, track the routing of cable lines, and detect network cable integrity and non-contact voltage.
- The meter is provided with both automatic/manual ranges.
- The meter is provided with the automatic shutdown function.
- The meter is provided with the reading hold function.
- The meter is provided with the maximum measurement.
- The meter is provided with low battery voltage indication.

2.1 Names of parts

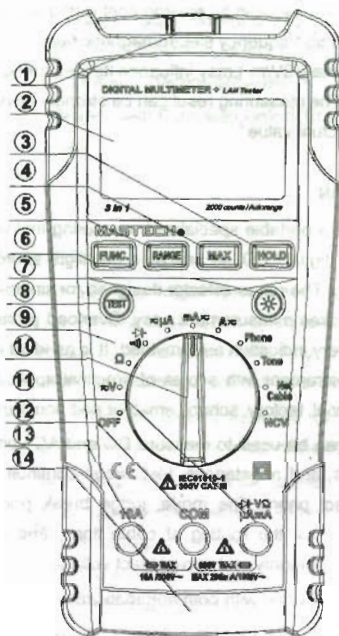

- 1) Non-contact voltage detection indicator light
- 2) LCD (liquid crystal display)
- 3) Data hold (HOLD)
- 4) Maximum measurement (MAX)
- 5) Range switch button (RANGE)
- 6) Function switch button (FUNC)
- 7) Backlight key
- 8) Test key
- 9) Panel
- 10) Rotary selector
- 11) mA/μA/V/Ω/jack
- 12) COM jack
- 13) 10A jack
- 14) Guard plate

2.2 Switches, buttons and input jacks

- | | |
|-----------|--|
| HOLD key | For reading holding |
| MAX key | For maximum measurement |
| RANGE key | For switching between auto and manual ranges |
| FUNC key | For switching among measuring functions |

Backlight key	For switching on/off the backlight
TEST key	For measurement
10A jack	Input jack for 10A current range
mA/μA/V/Ω jack	For mA/μA current, voltage, resistance and diode measurement
COM jack	Common terminal

2.3 Display



AC (alternating current)



DC (direct current)

AUTO

Auto range



Ohms (Resistance)



LCD diagram

V	Volts (Voltage)
A	Amperes (Current)

Hz	Hertz (Frequency)
μ, m, k, M	Symbols of units: micro, milli, kilo and million
o)	Continuity buzzer
→	Diode measurement
MAX	Maximum measurement
H	Reading being held
⊖	Low battery
☎	Phone standby
☎	Phone ringing
☎	Phone pick-up
RED - RING	The RING line is clamped by the red clip
RED - TIP	The TIP line is clamped by the red clip
(⊕)	Audio signal
① — ②	Cable pair 1-2
③ — ⑥	Cable pair 3-6
④ — ⑤	Cable pair 4-5
⑦ — ⑧	Cable pair 7-8
SHIELD	Cable shield
OPEN	Open circuit
SHORT	Short circuit
REVERSED	Reverse connection
MISWIRE	Miswiring
SPLIT PAIRS	Split pair

3. SPECIFICATIONS**3.1 General**

- 3.1.1 Auto range and manual range options are available.
- 3.1.2 Overload protection is available for all ranges.
- 3.1.3 Display: LCD.
- 3.1.4 Maximum value display: 1999 digits.
- 3.1.5 Polarity indication: automatic; '-' for negative polarity.
- 3.1.6 Over-range indication: '0L' or '--0L'.
- 3.1.7 Unit indication: function and energy unit indication.
- 3.1.8 Judging the ringing, standby or pick-up mode of the phone line.
- 3.1.9 Judging any breakpoint in the cable line, and tracking the routing of the cable line.
- 3.1.10 Detecting network cable integrity, judging open circuit, short circuit, miswiring, split pair and reverse connection of the network cable, and shield integrity, and displaying abnormality symbols.
- 3.1.11 Non-contact voltage detection.
- 3.1.12 Automatic power off time: 15 min
- 3.1.13 Fuse specification: F10A/500V, F200mA/1000V (quick acting)
- 3.1.14 Battery under-voltage indication: The LCD displays the  symbol.

- 3.1.15 Operating power: 6F22 9V batteries
- 3.1.16 Operating temperature: 0°C~40°C
- 3.1.17 Storage temperature: -10°C~50°C
- 3.1.18 Dimensions: 195×92×55mm
- 3.1.19 Weight: about 400g (including batteries)

3.2 Technical Index**3.2.1 DC Voltage**

Range	Resolution	Accuracy
200mV	0.1mV	±(0.5% of reading + 5 digits)
2V	1mV	
20V	0.01V	
200V	0.1V	
1000V	1V	±(0.8% of reading + 5 digits)

- Max. input voltage: 1000V DC

NOTE:

At the low voltage range, unsteady readings will appear before the test probes contact the circuit. This is normal because the meter is highly sensitive. When the test probes contact the circuit, the true reading will be displayed.

3.2.2 AC Voltage

Range	Resolution	Accuracy
200mV	0.1mV	$\pm(0.8\%$ of reading + 5 digits)
2V	1mV	
20V	0.01V	
200V	0.1V	
750V	1V	

- Max. input voltage: 750V AC
- Frequency range: 40~400Hz
- Response: average (rms of sine wave)

NOTE:

At the low voltage range, unsteady readings will appear before the test probes contact the circuit. This is normal because the meter is highly sensitive. When the test probes contact the circuit, the true reading will be displayed.

3.2.3 Resistance

Range	Resolution	Accuracy
200 Ω	0.1 Ω	$\pm(1.0\%$ of reading + 5 digits)
2K Ω	0.001K Ω	
20K Ω	0.01K Ω	
200K Ω	0.1K Ω	
2M Ω	0.001M Ω	
20M Ω	0.01M Ω	

3.2.4 Diode test

Range	Resolution	Function
	1mV	Displaying approximate forward voltage of diode

3.2.5 Short-circuit test

Range	Resolution	Function
	0.1 Ω	Giving an alarm if the resistance is less than 70 Ω

3.2.6 DC Current

Range	Resolution	Accuracy
200 μ A	0.1 μ A	$\pm(1.2\%$ of reading + 5 digits)
2000 μ A	1 μ A	
20mA	0.01mA	
200mA	0.1mA	$\pm(2.0\%$ of reading + 5 digits)
2A	0.001A	
20A	0.01A	

- Overload protection:

μ A, mA range: fuse 200mA/1000V (quick acting)

10A range: fuse 10A/500V (quick acting)

- Max. input current: μ A/mA jack (μ A range): 2000 μ A
 μ A/mA jack (mA range): 200mA
 10A jack: 10A

3.2.7 AC Current

Range	Resolution	Accuracy
200 μ A	0.1 μ A	$\pm(1.5\%$ of reading + 5 digits)
2000 μ A	1 μ A	
20mA	0.01mA	
200mA	0.1mA	$\pm(3.0\%$ of reading + 5 digits)
2A	0.001A	
20A	0.01A	

- Overload protection:

μ A, mA range: fuse 200mA/1000V (quick acting)

10A range: fuse 10A/500V (quick acting)

- Max. input current: μ A/mA jack (μ A range): 2000 μ A

μ A/mA jack (mA range): 200mA

10A jack: 10A

- Frequency range: 40~400Hz

- Response: average (rms of sine wave)

4. OPERATING INSTRUCTIONS

4.1 Function switching

- 1) Press the "FUNC" key to switch between AC and DC measurement at the current and voltage ranges.
- 2) Press the "FUNC" key to switch between the diode and continuity ranges.

4.2 Range switching

- 1) When the meter is turned on, it is at the auto range for measuring current, voltage and resistance.
- 2) Press the "RANGE" key to enter the manual range mode. The range will go one level up with each press and return to the lowest level when the highest level is reached.
- 3) Hold the "RANGE" key for more than 2 seconds to return to the auto range.

4.3 Maximum value measurement

- 1) The maximum value measurement function can be used when the meter is measuring current and voltage.
- 2) To display the measured maximum value during measurement, press the "MAX" key, and the measured maximum value will appear on the LCD.
- 3) Press the "MAX" key again to release the maximum value measurement function.

4.4 Reading holding

- 1) To hold the reading during measurement, press the "HOLD" key, and the displayed value on the LCD will be locked.
- 2) Press the "HOLD" key again to release the reading holding mode.

4.5 Backlight source

- 1) If the environment is too dark for reading during measurement, hold on to the "☉" key for more than 2 seconds to turn on the backlight source.
- 2) Hold on to the "☉" key again for more than 2 seconds to turn off the backlight source.
- 3) After the backlight source is turned on, if the "☉" key is not held down for more than 2 seconds, the backlight source will shut down automatically 15 seconds later.

4.6 Use of the test key

- 1) Press "TEST" to start detection when the meter is at the Phone (phone line mode detection), Tone (judgment and tracking of cable line), NetCable (network cable integrity detection) range.
- 2) After the detection, the detection result indicator will flash. Press the "TEST" key to stop flashing and get ready for the next detection.

4.7 Preparation for measurement

- 1) Turn the range selector and turn on the power. If the

battery voltage is low (about $\leq 7.2V$), the LCD will display the "  " symbol, when the batteries must be replaced.

- 2) The "" symbol beside the input line indicates that the input voltage or current should not exceed the indicated value. This is intended to protect the internal circuit from damage.
- 3) Set the range selector to the desired measurement function and range. In the manual range mode, if the scale of the measured value is unknown beforehand, the highest range should be set.
- 4) Connect the common test wire and then the live test wire during connection. Remove the live test wire first during disconnection.

4.8 Measurement of DC voltage** WARNING**

There is the risk of electric shock.

Pay special attention to avoid electric shock when measuring high voltages.

Do not input any voltage of over DC1000V, which may damage the internal circuit though a higher voltage may be displayed.

- 4.8.1 Plug the black probe into the COM jack and the red probe into the V jack.
- 4.8.2 Set the range selector to the  V range position.
- 4.8.3 Press the "FUNC" key to switch to the DC

measurement mode, and press the "RANGE" key to select the auto or manual mode.

- 4.8.4 Connect the test probes to the voltage source or load in parallel for measurement.
- 4.8.5 Take a reading in the main display area of the LCD. The polarity indication will show the polarity of the terminal connected by the red probe.

NOTE:

- 1) At the low voltage range, unsteady readings will appear before the test probes contact the circuit. This is normal because the meter is highly sensitive. When the test probes contact the circuit, the true reading will be displayed.
- 2) In the manual range mode, if the LCD displays "OL" or "-OL" only, it means the measurement has exceeded the range and a higher range should be selected.
- 3) In the manual range mode, if the scale of the measured value is unknown beforehand, the highest range should be set and then lowered down gradually.

4.9 Measurement of AC voltage**WARNING**

There is the risk of electric shock.

Pay special attention to avoid electric shock when measuring high voltages.

Do not input any voltage of over AC750V rms, which may damage the internal circuit though a higher voltage may be displayed.

- 4.9.1 Plug the black probe into the COM jack and the red probe into the V jack.
- 4.9.2 Set the range selector to the \sim V range position.
- 4.9.3 Press the "FUNC" key to switch to the AC measurement mode, and press the "RANGE" key to select the auto or manual mode.
- 4.9.4 Connect the test probes to the voltage source or load in parallel for measurement.
- 4.9.5 Take a reading in the main display area of the LCD.



NOTE:

- 1) At the low voltage range, unsteady readings will appear before the test probes contact the circuit. This is normal because the meter is highly sensitive. When the test probes contact the circuit, the true reading will be displayed.
- 2) In the manual range mode, if the LCD displays 'OL' only,

it means the measurement has exceeded the range and a higher range should be selected.

- 3) In the manual range mode, if the scale of the measured value is unknown beforehand, the highest range should be set and then lowered down gradually.

4.10 Diode test

- 4.10.1 Plug the black probe into the COM jack and the red probe into the  jack.
- 4.10.2 Set the range selector to the  range position.
- 4.10.3 Press the "FUNC" key to switch to the  test mode.
- 4.10.4 Connect the red probe to the anode and the black probe to the cathode of the diode for testing.
- 4.10.5 Take a reading in the main display area of the LCD.

NOTE:

- The meter indicates the approximate forward voltage drop of the diode.
- If the test probes are reversed or open, the LCD will display '0L'.



4.11 Circuit continuity test



WARNING

There is the risk of electric shock.

When measuring the continuity of a circuit, make sure the power is disconnected and the capacitor on the circuit is fully discharged.

- 4.11.1 Plug the black probe into the COM jack and the red probe into the Ω jack.
- 4.11.2 Set the range selector to the  range position.
- 4.11.3 Press the "FUNC" key to switch to the  circuit continuity test mode.
- 4.11.4 Connect the test probes to the circuit for measurement.
- 4.11.5 If the resistance of the circuit under test is less than 70 Ω , the buzzer in the meter will beep.
- 4.11.6 Read the resistance of the circuit in the main display area of the LCD.

NOTE:

If the test probes are open or the resistance of the circuit under test is over 200 Ω , "0L" will be displayed on the LCD.

4.12 Resistance measurement

**WARNING**

There is the risk of electric shock.

When measuring the impedance of a circuit, make sure the power is disconnected and the capacitor on the circuit is fully discharged.

- 4.12.1 Plug the black probe into the COM jack and the red probe into the Ω jack.
- 4.12.2 Set the range selector to the Ω range position.
- 4.12.3 Press the "RANGE" key to select the auto or manual range.
- 4.12.4 Connect the test probes to the resistor or circuit under test for measurement.
- 4.12.5 Take a reading in the main display area of the LCD.

NOTE:

- 1) In the manual range mode, if the LCD displays 'OL' only, it means the measurement has exceeded the range and a higher range should be selected.
- 2) In case of open input, the LCD will display the 'OL' over-range mode.
- 3) If the resistance to be measured is higher than $1M\Omega$, the meter may take a few seconds to get a steady reading. This is normal for high resistance reading.

4.13 Measurement of DC current

**WARNING**

There is the risk of electric shock.

Turn off the power of the circuit under test, and then connect the meter to the circuit in series for measurement.

- 4.13.1 Plug the black probe into the COM jack. When the current to be measured is below 200mA, plug the red probe into the $\mu A/mA$ jack; when the current to be measured is over 200mA but below 10A, plug the red probe into the 10A jack.
- 4.13.2 Set the range selector to the desired  current range position.
- 4.13.3 Press the "FUNC" key to switch to the DC measurement mode, and press the "RANGE" key to select the auto or manual mode.
- 4.13.4 Connect the test probes to the circuit under test in series for measurement.
- 4.13.5 Take a reading in the main display area of the LCD. The polarity indication will show the polarity of the terminal connected by the red probe.

NOTE:

- 1) In the manual range mode, if the LCD displays 'OL' only,

it means the measurement has exceeded the range and a higher range should be selected.

- 2) In the manual range mode, if the scale of the measured value is unknown beforehand, the highest range should be set.
- 3) " \triangle " means the maximum input current of the mA jack is 200mA and that of the 10A jack is 10A. At the 10A jack, excess current will blow the fuse.

4.14 Measurement of AC current



WARNING

There is the risk of electric shock.

Turn off the power of the circuit under test, and then connect the meter to the circuit in series for measurement.

- 4.14.1 Plug the black probe into the COM jack. When the current to be measured is below 200mA, plug the red probe into the uA/mA jack; when the current to be measured is over 200mA but below 10A, plug the red probe into the 10A jack.
- 4.14.2 Set the range selector to the desired  current range position.
- 4.14.3 Press the "FUNC" key to switch to the DC measurement mode, and press the "RANGE" key to select the auto or manual mode.

4.14.4 Connect the test probes to the circuit under test in series for measurement.

4.14.5 Take a reading in the main display area of the LCD.



NOTE:

- 1) In the manual range mode, if the LCD displays 'OL' only, it means the measurement has exceeded the range and a higher range should be selected.
- 2) In the manual range mode, if the scale of the measured value is unknown beforehand, the highest range should be set.
- 3) " \triangle " means the maximum input current of the mA jack is 200mA and that of the 10A jack is 10A. At the 10A jack, excess current will blow the fuse.

4.15 Phone line mode detection

- 4.15.1 Plug the attached detection line into the jack in front of the meter and turn the rotary selector to the Phone range.
- 4.15.2 Clamp the two wires of the phone line with the two clips of the connecting line or plug the modular plug into the phone socket. Press the "TEST" key, and the "Phone" symbol will flash and the phone line mode detection will begin.

- 4.15.3 The "Phone" symbol stops flashing and the detection result is displayed. If the detection result symbol flashes, the mode of the phone line is as follows:

RED-TIP flashing	The TIP line is clamped by the red clip.
RED-RING flashing	The RING line is clamped by the red clip.
 flashing	The phone line is in the ringing mode.
 flashing	The phone line is in the standby mode.
 flashing	The phone line is in the pick-up mode.

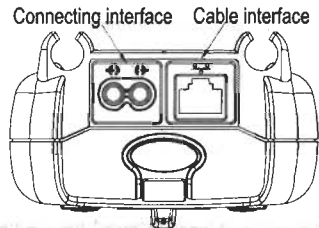
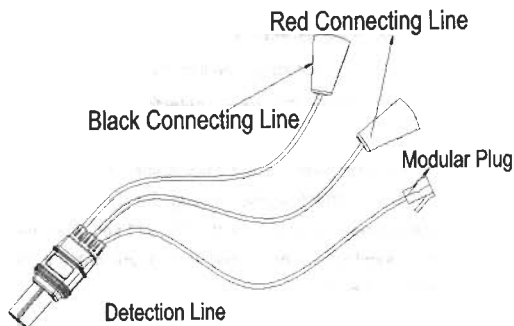
**NOTE:**

If the RED-TIP symbol flashes, the standby and pick-up modes of the phone line cannot be judged. In this case, be sure to clamp the RING line with the red clip and the TIP line with the black clip.

4.16 Judgment and tracking of cable line

- 4.16.1 Plug the attached detection line into the jack in front of the meter and turn the rotary selector to the Tone range.
- 4.16.2 Connect the outgoing wire of the connecting line to the target cable pair or connect the red line to the target cable and the black line to the ground.
- 4.16.3 Press the "TEST" key, and the "📞" symbol will flash to transmit an audio signal. Bring the antenna of the receiver close to the target cable and hold down the Receive key to receive the audio signal transmitted, and then you can judge the routing and continuity of the

cable. If there is any break point on the cable, its position can be judged.

NOTE:

- 1) There should be no AC or DC signal in the cable under test.
- 2) If the audio signal is badly received, the volume switch of the receiver can be adjusted.

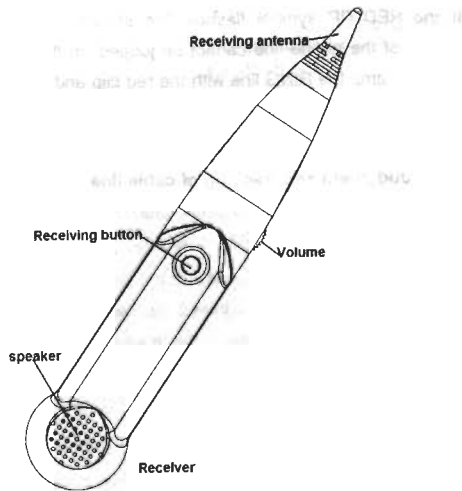
**4.17 Network cable Integrity test**

- 4.17.1 Regular T568A/T568B cables can be judged for open circuit, short circuit, miswiring, split pair, reverse connection and shield integrity, and any abnormality can be specified.
- 4.17.2 Insert both ends of the cable into the jacks in the front and lower part of the meter.
- 4.17.3 Press the "TEST" key for testing. If the abnormality remains after the test, the "Abnormal" symbol will flash.
- 4.17.4 The front jack box can be separated to detect any fixed cable as the remote terminal conveniently.

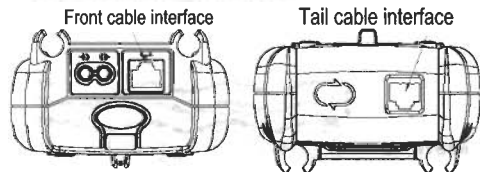

- 4.17.5 Insert a slotted screwdriver or any other flat object into the notch and push up hard to remove the front cable interface.

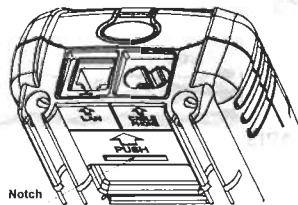

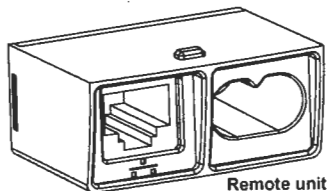

Remote unit

4.17.6 Below is a detailed description of different abnormalities:

SHORT



MISWIRE



REVERSD

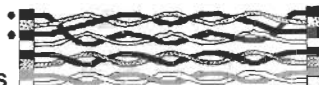

SPLIT PAIRS

**NOTE:**

- 1) If the cable under test has no shield, the shield symbol will flash to indicate open circuit, which is normal.

4.18 Non-contact voltage detection

- 4.18.1 Sockets and power cords can be detected for the presence of AC voltage.
- 4.18.2 Bring the upper part of the meter **close** to a conductor. When a voltage is detected, the meter will give a sound and provide visual indication.

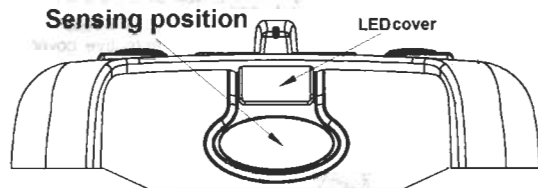

Front detection area of the meter

⚠ WARNING

There is the risk of electric shock.

A voltage may still be present even if there is no indication. Do not rely on the non-contact voltage detection function to judge whether a voltage is present on a shielded wire. The detection operation may be affected by such factors as socket design, insulation thickness and type of wires.

4.19 Operating precautions of protective cover

⚠ WARNING

There is the risk of electric shock.

After the protective cover is lost, the voltage and current measurement function of the meter should be disabled for fear of electric shock.

- 4.19.1 There is a protective cover at the tail of the meter. To avoid the risk of electric shock, the cable interface must be protected by the protective cover when the cable detection function is not used.
- 4.19.2 The figure below shows how the protective cover is used when the cable detection function is used.

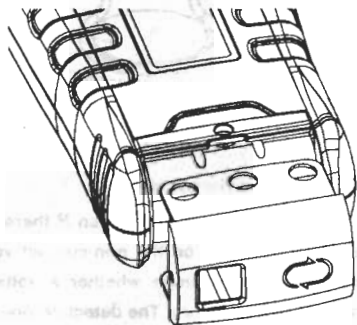

- 4.19.3 The figure below shows how the protective cover is used when the cable detection function is not used.

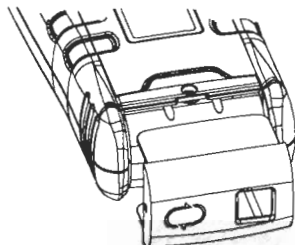

4.20 Automatic power off

- 4.20.1 If the FUNC key or the range selector is not operated within 15 minutes during measurement, the meter will be shut down and enter the sleeping mode to save electricity.
- 4.20.2 To disable the automatic power off function, hold on to the HOLD key to start up the meter or press the HOLD key in the sleeping mode to wake it up.

5. MAINTENANCE

5.1 Replacement of batteries

⚠ WARNING

Before opening the battery cover of the meter, remove the test probes from the circuit under test to avoid the risk of electric shock.

- 5.1.1 When the "  " symbol is displayed, the batteries should be replaced immediately.

- 5.1.2 Turn the range selector to OFF and remove the test wires from the input terminals.
- 5.1.3 Unfasten the screws and remove the battery cover.
- 5.1.4 Mount new batteries, replace the battery cover and fasten the screws.

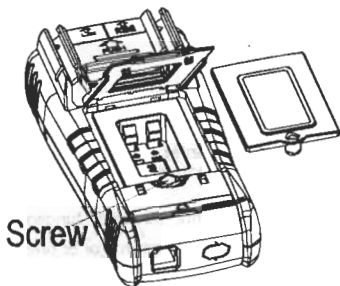

5.2 Replacement of fuse

⚠ WARNING

Before opening the battery cover, remove the test probes from the circuit under test to avoid the risk of electric shock.

To avoid fire hazards, be sure to use the designated fuse (at rated voltage, amperage and blow rate).

- 5.2.1 Turn the range selector to OFF and remove the test leads from the input terminals.
- 5.2.2 Remove the protective cover and unfasten the screws.
- 5.2.3 Remove the rear case, pry up one end of the fuse gently and then remove the fuse from the clip.
- 5.2.4 After a new fuse is mounted, replace the rear case and fasten the screws.

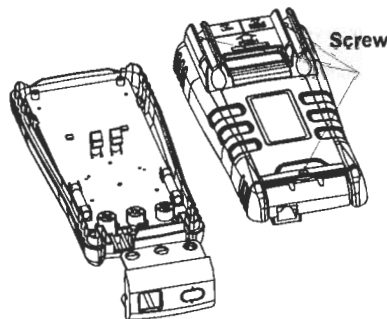

5.3 Replacement of test probes

⚠ WARNING

The test probes must be replaced with those of the same model or class, and must be kept in good condition. Ratings of test probes: CAT III 600V 10A.

If the insulation of any test probe is damaged, e.g., a wire is exposed, the test probe must be replaced.

6. ACCESSORIES

1)	Test probes	1 pair
2)	Test connect line	1
3)	Receiver	1
4)	Protective cover	1
5)	Remote unit	1
6)	Operation manual	1