

cPCI-9112/PCI-9112
16-CH, 12-bit DAS Card
for PCI / 3U CompactPCI
(C/C++ & DLL Library)

@Copyright 1996~1999 ADLink Technology Inc.
All Rights Reserved.

Manual Rev 3.22: November 17, 1999

The information in this document is subject to change without prior notice in order to improve reliability, design and function and does not represent a commitment on the part of the manufacturer.

In no event will the manufacturer be liable for direct, indirect, special, incidental, or consequential damages arising out of the use or inability to use the product or documentation, even if advised of the possibility of such damages.

This document contains proprietary information protected by copyright. All rights are reserved. No part of this manual may be reproduced by any mechanical, electronic, or other means in any form without prior written permission of the manufacturer.

Trademarks

NuDAQ®, NuIPC® are registered trademarks of ADLink Technology Inc., Other product names mentioned herein are used for identification purposes only and may be trademarks and/or registered trademarks of their respective companies.

CONTENTS

How to Use This Guide	v
CHAPTER 1 Introduction	1
1.1 Features	1
1.2 Applications.....	2
1.3 Specifications	2
1.4 Software Supporting	4
CHAPTER 2 Installation.....	5
2.1 What You Have	5
2.2 Unpacking.....	6
2.3 Device Installation for Windows 95	6
2.4 PCB Layout.....	8
2.5 Jumper and DIP Switch Description	10
2.6 Plug & Play Configuration.....	10
2.7 Analog Input Channel Configuration	10
2.8 Clock Source Setting.....	11
2.9 D/A Reference Voltage Setting.....	12
2.10 PCI Configuration	13
2.11 Running 9112Util.EXE	14
CHAPTER 3 Signal Connections.....	15
3.1 Connectors Pin Assignment	15
3.1.1 <i>Pin Assignment of PCI-9112</i>	15
3.1.2 <i>Pin Assignment of cPCI-9112</i>	18
3.2 Analog Input Signal Connection.....	19
3.3 Analog Output Signal Connection	22
3.4 Digital I/O Connection	22

3.5	Timer / Counter Connection	23
3.6	Daughter Board Connection.....	24
3.6.1	Connect with ACLD-8125	24
3.6.2	Connect with ACLD-9137	24
3.6.3	Connect with ACLD-9182	24
3.6.4	Connect with ACLD-9185	24
3.6.5	Connect with ACLD-9138 and ACLD-9188	24
CHAPTER 4 Register Format		25
4.1	I/O Port Address.....	25
4.2	A/D Data Registers.....	26
4.3	D/A Output Register	26
4.4	A/D control Register	27
4.5	A/D Status Register.....	29
4.6	Software Trigger Register	30
4.7	Digital I/O register	30
4.8	Internal Timer/Counter Register.....	31
4.12	High Level Programming.....	32
4.13	Low Level Programming.....	32
CHAPTER 5 Operation Theorem		33
5.1	A/D Conversion.....	33
5.1.1	A/D Conversion Procedure	33
5.1.2	A/D Trigger Modes.....	34
5.1.3	A/D Data Transfer Modes	35
5.2	D/A Conversion.....	36
5.3	Digital Input and Output	37
5.4	Timer/Counter Operation.....	37
CHAPTER 6 Calibration & Utilities		41
6.1	What do you need	41
6.2	VR Assignment	41

6.3	A/D Adjustment.....	42
6.3.1	Bipolar Calibration.....	42
6.3.2	Unipolar Calibration.....	42
6.4	D/A Adjustment.....	43
6.4.1	Reference Voltage Calibration.....	43
6.4.2	D/A Channel Calibration.....	43

CHAPTER 7 Software Utility and Library 45

7.1	Installation.....	46
7.1.1	MS-DOS Installation :.....	46
7.1.2	Windows 95 DLL Installation:.....	46
7.2	Software Utility.....	47
7.2.1	Running the Utility.....	48
7.2.2	System Configuration.....	48
7.2.3	Calibration.....	48
7.2.4	Functional Testing.....	49
7.3	C/C++ & DLL Library.....	49
7.3.1	_9112_Initial.....	50
7.3.2	_9112_DI.....	51
7.3.3	_9112_DI_Channel.....	52
7.3.4	_9112_DO.....	53
7.3.5	_9112_DA.....	53
7.3.6	_9112_AD_Set_Channel.....	55
7.3.7	_9112_AD_Set_Range.....	55
7.3.8	_9112_AD_Set_Mode.....	57
7.3.9	_9112_AD_Set_Autoscan.....	58
7.3.10	_9112_AD_Soft_Trig.....	59
7.3.11	_9112_AD_Aquire.....	60
7.3.12	_9112_AD_DMA_Start.....	61
7.3.13	_9112_AD_DMA_Status.....	64
7.3.14	_9112_AD_DMA_Stop.....	65
7.3.15	_9112_ContDmaStart.....	66
7.3.16	_9112_CheckHalfReady.....	68
7.3.17	_9112_DblBufferTransfer.....	68
7.3.18	_9112_GetOverrunStatus.....	69

7.3.19	<i>_9112_ContDmaStop</i>	70
7.3.20	<i>_9112_AD_INT_Start</i>	70
7.3.21	<i>_9112_AD_INT_Status</i>	72
7.3.22	<i>_9112_AD_INT_Stop</i>	74
7.3.23	<i>_9112_AD_Timer</i>	74
7.3.24	<i>_9112_TIMER_Start</i>	76
7.3.25	<i>_9112_TIMER_Read</i>	76
7.3.26	<i>_9112_TIMER_Stop</i>	76
7.3.27	<i>_9112_Alloc_DMA_Mem</i>	77
7.3.28	<i>_9112_Free_DMA_Mem</i>	78
7.3.29	<i>_9112_Get_Sample</i>	78

Appendix A. Demo. Programs..... 81

Product Warranty/Service 83

How to Use This Guide

This manual is designed to help you use the PCI-9112 and cPCI-9112. The functionality of PCI-9112 and cPCI-9112 are the same. Therefore, the "PCI-9112" in this manual represent both the PCI-9112 and cPCI-9112 if no specified.

The manual describes how to modify various settings on the PCI-9112 card to meet your requirements. It is divided into six chapters:

- Chapter 1, "**Introduction,**" gives an overview of the product features, applications, and specifications.
- Chapter 2, "**Installation,**" describes how to install the PCI-9112. The layout of PCI-9112 is shown, jumper setting for analog input channel configuration, D/A reference voltage setting are specified.
- Chapter 3, "**Signal Connection,**" describes the connectors' pin assignment and how to connect the outside signal and devices with the PCI-9112.
- Chapter 4, "**Registers Structure & Format,**" describes the details of register format and structure of the PCI-9112, this information is very important for the programmers who want to control the hardware by low-level programming.
- Chapter 5, "**Operation Theorem**" describes how to operate the PCI-9112. The A/D, D/A, DIO and timer/counter functions are introduced. Also, some programming concepts are specified.
- Chapter 6, "**Calibration & Utility,**" describes how to calibrate the PCI-9112 for accurate measurement.
- Chapter 7, "**Software Utility,**" describes the software utility and library of PCI-9112, and also describes how to install and operate the utility and library to meet your requirements and help you program your own software application.

1

Introduction

The PCI-9112 is an advanced performance, data acquisition card based on the 32-bit PCI Bus architecture. High performance designs and the state-of-the-art technology make this card ideal for data logging and signal analysis applications in medical, process control, and etc.

1.1 Features

The PCI-9112 PCI Bus Advanced Data Acquisition Card provides the following advanced features:

- 32-bit PCI-Bus
- 12-bit analog input resolution
- On-board A/D FIFO memory
- Auto-scanning channel selection
- Up to 110Khz A/D sampling rates
- 16 single-ended or 8 differential analog input channels
- Bipolar or unipolar input signals
- Programmable gain of x0.5, x1, x2, x4, x8
- On-chip sample & hold
- Two 12-bit monolithic multiplying analog output channels
- 16 digital output channels
- 16 digital input channels
- 3 independent programmable 16-bit down counters
- Three A/D trigger modes : software trigger, programmable pacer trigger, and external pulse trigger.
- Integral DC-to-DC converter for stable analog power source
- 37-pin D-type connector for PCI-9112
- 100-pin SCSI-type connector for cPCI-9112
- Compact size : half-size PCB

1.2 Applications

- Industrial and laboratory ON/OFF control
- Energy management
- Annunciation
- 16 TTL/DTL compatible digital input channels
- Security controller
- Product test
- Event and frequency counting
- Waveform and pulse generation
- BCD interface driver

1.3 Specifications

- ◆ Analog Input (A/D)
 - Converter : **B.B. ADS774, successive approximation type**
 - Input Channels : **16 single-ended or 8 differential**
 - Resolution : **12-bit**
 - Input Range : (**Software controlled**)
 - Bipolar** : $\pm 10V, \pm 5V, \pm 2.5V, \pm 1.25V, \pm 0.625V$
 - Unipolar** : $0\sim 10V, 0\sim 5V, 0\sim 2.5V, 0\sim 1.25V$
 - Conversion Time : **8 m sec**
 - Overvoltage protection : **Continuous $\pm 30V$ maximum**
 - Accuracy :

GAIN = 0.5, 1	0.01% of FSR ± 1 LSB
GAIN = 2, 4	0.02% of FSR ± 1 LSB
GAIN = 8	0.04% of FSR ± 1 LSB
 - Input Impedance : **10 MW**
 - Trigger Mode : **Software, Timer Pacer, and External trigger**
 - Data Transfer : **Program control, Interrupt, DMA (Bus mastering)**
 - Data Throughput : **110KHz (maximum)**
 - FIFO memory: **2K Words (for cPCI-9112 only)**
- ◆ Analog Output (D/A)
 - Output Channel: **2 double-buffered analog outputs**
 - Resolution : **12-bit**
 - Output Range :
 - Internal reference** : (unipolar) $0\sim 5V$ or $0\sim 10V$
 - External reference** : (unipolar) max. $+10V$ or $-10V$

- Converter : **AD 7541 or equivalent, monolithic multiplying**
 - Settling Time : **30 m sec**
 - Linearity : **±1/2 bit LSB**
 - Output Driving : **±5mA max.**
- ◆ Digital I/O (DIO)
- Channel : **16 TTL compatible inputs and outputs**
 - Input Voltage :
Low : Min. 0V ; Max. 0.8V
High : Min. +2.0V
 - Input Load:
Low : +0.5V @ -0.2mA max.
High : +2.7V @ +20mA max.
 - Output Voltage:
Low : Min. 0V ; Max. 0.4V
High : Min. +2.4V
 - Driving Capacity:
Low : Max. +0.5V at 8.0mA (Sink)
High : Min. 2.7V at 0.4mA (Source)
- ◆ Programmable Counter
- Device : **8254**
 - A/D pacer : **32-bit timer (two 16-bit counter cascaded together) with a 2MHz time base**
 - Counter : **One 16-bit counter with a 2MHz time base**
 - Pacer Output : **0.00046 Hz ~ 0.5 MHz**
- ◆ General Specifications
- I/O Base Address : **9 consecutive DWORD (double word) address location**
 - Connector : **37-pin D-type connector**
 - Operating Temperature : **0° C ~ 60° C**
 - Storage Temperature : **-20° C ~ 80° C**
 - Humidity : **5 ~ 95%, non-condensing**
 - Power Consumption:
PCI-9112:
+5 V @ 475 mA max
+12V @ 150 mA max
cPCI-9112:
+5 V @ 630 mA max
+12V @ 20 mA max
 - Dimension :
PCI-9112: Compact size only 98mm(H) X 173mm(L)
cPCI-9112: Standard CompactPCI form factor

1.4 Software Supporting

There are several software options help you get your application running quickly and easily.

1. Linking with data acquisition software packages:

- DASyLab 5.0
- LabVIEW (PCIS-LVIEW)
- HP-VEE (PCIS-VEE)
- Intouch 7.0 (PCIS-DDE)

2. Custom Program:

For the customer who are writing their own programs, the PCI-9112 is supported by a comprehensive set of drivers and programming tools. These software supports are available in multiple platforms.

- DOS Borland C programming library.
- Dynamic linking library for Win-95/98.
- PCIS-DASK: Advanced data acquisition software kit for Windows NT and Windows 98.
- DAQBench: 32-bit ActiveX Controls library for Windows NT only. **(DAQBench is optional, please contact with your dealer to purchase it. The DAQBench inside the CD is a demo version, which can run two hours for demonstration purpose. You can also contact with your dealer to purchase the license serial code.)**

2

Installation

This chapter describes how to install the PCI-9112. At first, the contents in the package and unpacking information that you should be careful are described.

The PCI-9112 does an automatic configuration of the IRQ, port address, and BIOS address. So, you do not need to set above configuration as you use ISA form factor DAS card. For system reliability, some critical settings for analog input and output need to be assigned manually, because these settings will not be changed after your data acquisition system configuration is decided. It will let your system get more reliability and safety (user can not change the configuration by software directly) when your system is running.

2.1 What You Have

In addition to this *User's Guide*, the package includes the following items:

- **PCI-9112 Enhanced Multi-function Data Acquisition Card**
- **Manual & Software Utility CD**

If any of these items is missing or damaged, contact the dealer from whom you purchased the product. Save the shipping materials and carton in case you want to ship or store the product in the future.

2.2 Unpacking

Your PCI-9112 card contains sensitive electronic components that can be easily damaged by static electricity.

The card should be handled on a grounded anti-static mat. The operator should be wearing an anti-static wristband, grounded at the same point as the anti-static mat.

Inspect the card module carton for obvious damage. Shipping and handling may cause damage to your module. Be sure there are no shipping and handling damages on the module before processing.

After opening the card module carton, extract the system module and place it only on a grounded anti-static surface with component side up.

Again inspect the module for damage. Press down on all the socketed IC's to make sure that they are properly seated. Do this only with the module placed on a firm flat surface.

Note : DO NOT APPLY POWER TO THE CARD IF IT HAS BEEN DAMAGED.

You are now ready to install your PCI-9112.

2.3 Device Installation for Windows 95

While you first plug PCI-9112 card and enter Windows 95, the system will detect this device automatically and show the following dialog box that prompts you to select the device information source.

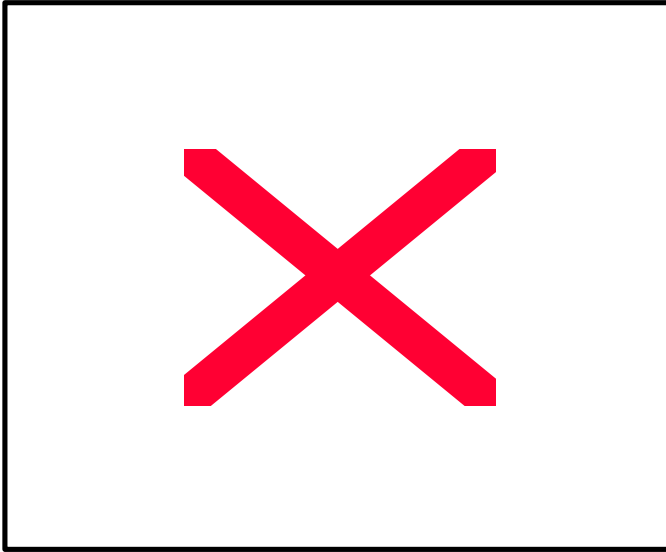

Choose the default option “*Driver from disk provided by hardware manufacturer*” and then a dialog box is shown to prompt you give the path of installation disk.

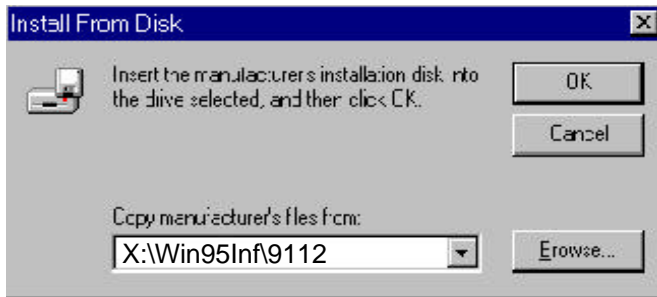

Place ADLink's “Manual & Software Utility” CD into the appropriate CD driver. Type “X:\Software\NuDAQPCI\9112\ Win95” in the input field (X indicates the CD ROM driver) and then click OK. The system will start the installation of PCI-9112.

2.4 PCB Layout

PCI-9112 Layout

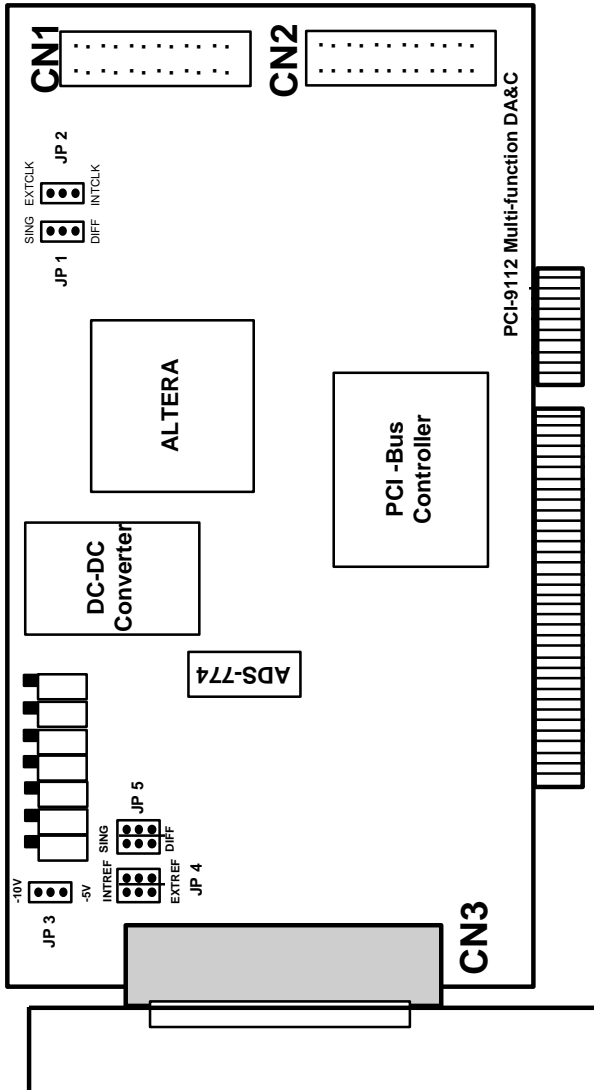

Figure 2.1 PCB Layout of the PCI-9112



cPCI-9112 Layout

Figure 2.2 PCB Layout of the PCI-9112

2.5 Jumper and DIP Switch Description

You can change the ACL-9112's analog input channel mode, clock source, and analog output range. The card's jumpers and switches are preset at the factory. You can change the jumper settings for your own applications.

A jumper switch is closed (sometimes referred to as "shorted") with the plastic cap inserted over two pins of the jumper. A jumper is open with the plastic cap inserted over one or no pin(s) of the jumper.

2.6 Plug & Play Configuration

For system reliability and safety when your data acquisition system is running, the design of PCI-9112 still kept some board configurations to be set manually. These setting are listed as below.

Configuration	Attributes	Jumpers(PCI-9112)	Jumpers(CPCI-9112)
Analog Inputs	Single-ended or Differential Analog Input	JP1 and JP5	JP1 and JP4
Clock Source	Internal Clock or External Clock	JP2	JP2
D/A Reference Voltage	-10V or -5V	JP3	JP3
D/A Reference Source	Internal Reference or External Reference	JP4	JP5

Table 2.1 Jumpers Listing Table

2.7 Analog Input Channel Configuration

The PCI-9112 offers 16 single-ended or 8 differential analog input channels. The jumper JP1 and JP5 control the analog input channel configuration. The settings of JP1 and JP5 are specified as following illustration.

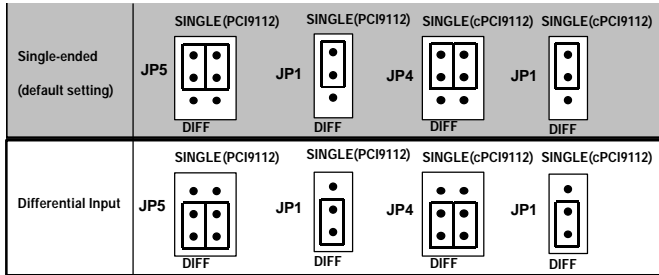

Figure 2.2 Analog Input Mode Setting

2.8 Clock Source Setting

The 8254 programmable interval timer is used in the PCI-9112. It provides 3 independent channels of 16-bit programmable down counters. The input of counter 2 is connected to a precision 2MHz oscillator for internal pacer. The input of counter 1 is cascaded from the output of counter 2. The channel 0 is free for user's applications. There are two selections for the clock source of channel 0 : the internal 2MHz clock or the external clock signal from connector CN3 pin 37. The setting of clock is shown as Figure 2.3.

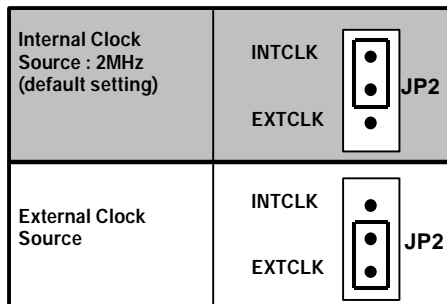

Figure 2.3 Timer's Clock Source Setting

2.9 D/A Reference Voltage Setting

The D/A converter's reference voltage source can be *internal* or *external* generated. The external reference voltage comes from connector CN3 pin 31 (*ExtRef1*) and pin12 (*ExtRef2*), see section 3.1. The reference source of D/A channel 1 and channel 2 are selected by JP4, respectively. Their possible settings are shown as below:

<p>D/A CH1 is External D/A CH2 is External</p>	<p style="text-align: center;">JP4(PCI-9112) JP5(cPCI-9112)</p> <p style="text-align: center;">INTREF  INTREF</p> <p style="text-align: center;">ExtRef1  ExtRef2</p>
<p>D/A CH1 is External D/A CH2 is Internal</p>	<p style="text-align: center;">JP4(PCI-9112) JP5(cPCI-9112)</p> <p style="text-align: center;">INTREF  INTREF</p> <p style="text-align: center;">ExtRef1  ExtRef2</p>
<p>D/A CH1 is Internal D/A CH2 is External</p>	<p style="text-align: center;">JP4(PCI-9112) JP5(cPCI-9112)</p> <p style="text-align: center;">INTREF  INTREF</p> <p style="text-align: center;">ExtRef1  ExtRef2</p>
<p>D/A CH1 is Internal D/A CH2 is Internal (default setting)</p>	<p style="text-align: center;">JP4(PCI-9112) JP5(cPCI-9112)</p> <p style="text-align: center;">INTREF  INTREF</p> <p style="text-align: center;">ExtRef1  ExtRef2</p>

Figure 2.4 Analog Output Voltage Setting

The internal A/D reference voltage can be set to -5V or -10V by JP3. The possible configurations are specified as Figure 2.5. Note that the internal reference voltage is used only when the JP4 is set to internal reference only.

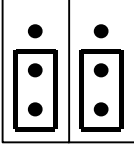
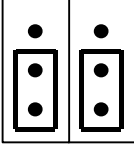
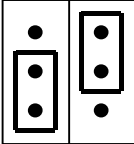
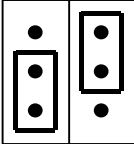
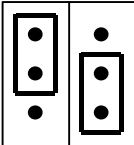
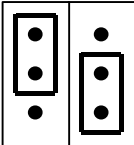
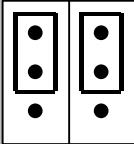
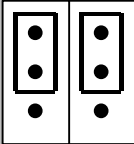
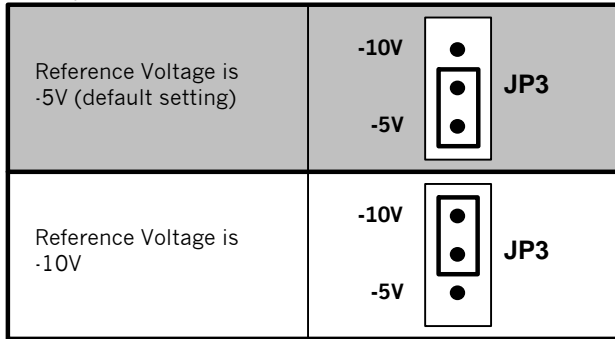

Figure 2.5 Internal Reference Voltage Setting

Note : If the -10V D/A reference voltage is selected, the D/A output range is 0V~10V. On the other hand, if the -5V is selected, the D/A output range is 0V~5V.

2.10 PCI Configuration

1. Plug and Play :

As a plug and play component, the board requests an interrupt number via a system call. The system BIOS responds with an interrupt assignment based on the board information and on known system parameters. These system parameters are determined by the installed drivers and the hardware load seen by the system.

2. Configuration :

The board configuration is done on a board-by-board basis for all PCI form factor boards on your system. Because configuration is controlled by the system and software, so there is no jumpers for base-address, DMA, and interrupt IRQ need to be set by the user.

The configuration is subject to change with every boot of the system as new boards are added or boards are removed. So, there is no idea what's going on to be installed.

3. Trouble shooting :

If your system won't boot or if you experience erratic operation with your PCI board in place, it's likely caused by an interrupt conflict (perhaps because you incorrectly described the ISA setup). In general, the solution, once you determine it is not a simple oversight, is to consult the BIOS documentation that come with your system.

2.11 Running 9112Util.EXE

After your PCI-9112 are installed on your system, you can run the 9112UTIL.EXE utility to setup and test the functionality of PCI-9112. The 9112UTIL.EXE is included in the CD, which comes equipped with the PCI-9112 package.

The 9112UTIL.EXE includes six functions, they are :

1. Configuration : Check the hardware setting of your PCI-9112.
2. Calibration : Calibrate the A/D and D/A measurement accuracy of your PCI-9112.
3. Software Trigger Testing :
Testing utility for software polling A/D, D/A and Digital I/O.
4. Interrupt Testing : Testing utility for interrupt A/D data transfer mode.
5. DMA Testing : Testing utility for DMA (bus-mastering) A/D data transfer mode.
6. Quit : Exit the utility.

3

Signal Connections

This chapter describes the connector of the PCI-9112, also the signal connection between the PCI-9112 and external devices, such as daughter boards or other devices.

3.1 Connectors Pin Assignment

3.1.1 Pin Assignment of PCI-9112

The PCI-9112 comes equipped with two 20-pin insulation displacement connectors - CN1 and CN2 and one 37-pin D-type connector - CN3. The CN1 and CN2 are located on board and CN3 located at the rear plate.

CN1 is used for digital signal input, CN2 for digital signal output, CN3 for analog input, analog output and timer/counter's signals. The pin assignment for each connectors are illustrated in the Figure 3.1 ~ Figure 3.3.

· **CN 1: Digital Signal Input (*DI 0 - 15*)**

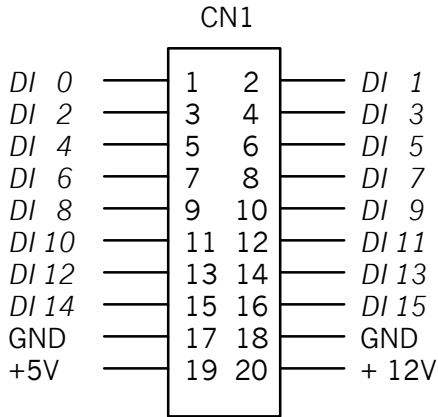

Figure 3.1. Pin Assignment of CN1

· **CN 2: Digital Signal Output (*DO 0 - 15*)**

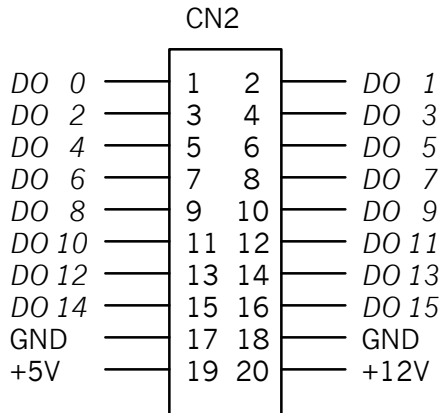

Figure 3.2. Pin Assignment of CN2

Legend :

- DO n* : Digital output signal channel *n*
- DI n* : Digital input signal channel *n*
- GND : Digital ground

**CN 3 : Analog Input/Output & Counter/Timer
(for single-ended connection)**

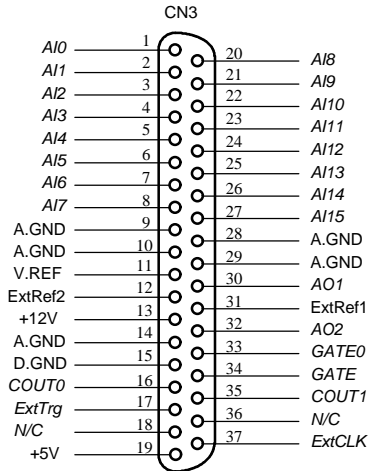

Figure 3.3a. Pin Assignment of CN3

**CN 3 : Analog Input/Output & Counter/Timer
(for differential connection)**

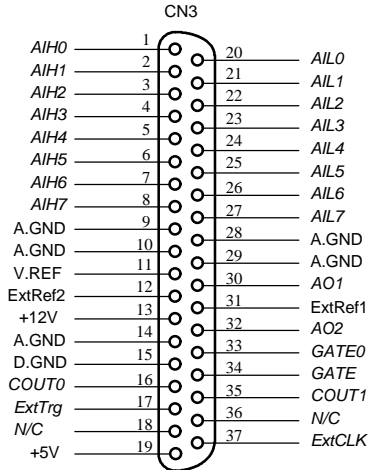
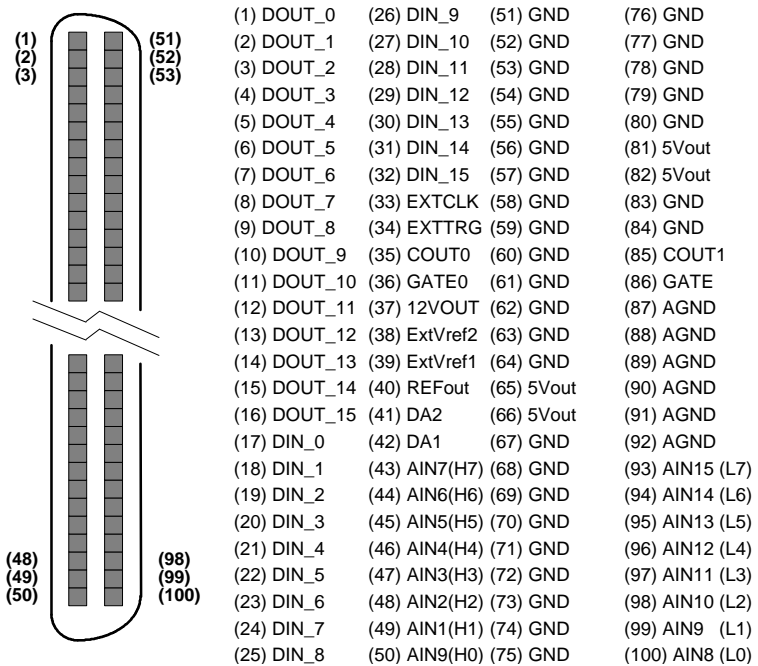

Figure 3.3b. Pin Assignment of CN3

Legend :

- AIn* : Analog Input Channel *n* (single-ended)
- AIHn* : Analog High Input Channel *n* (differential)
- AILn* : Analog Low Input Channel *n* (differential)
- ExtRef n* : External Reference Voltage for D/A CH *n*
- AOn* : Analog Output Channel *n*
- ExtCLK* : External Clock Input
- ExtTrig* : External Trigger Signal
- CLK* : Clock input for 8254
- GATE* : Gate input for 8254
- COUt n* : Signal output of Counter *n*
- V.ERF : Voltage Reference
- A.GND : Analog Ground
- GND : Ground

3.1.2 Pin Assignment of cPCI-9112



Legend :

<i>AIN_m</i>	: Analog Input Channel <i>m</i> (single-ended)
<i>AINH_m</i>	: Analog High Input Channel <i>m</i> (differential)
<i>AINL_m</i>	: Analog Low Input Channel <i>m</i> (differential)
<i>ExtTrig</i>	: External AD Trigger Signal
<i>DIN_x</i>	: Digital Input Channel <i>x</i>
<i>DOUT_x</i>	: Digital Output Channel <i>x</i>
<i>ExtCLK</i>	: External Clock Input for 8254 Counter #0
<i>COU_{T n}</i>	: Signal output of Counter <i>n</i>
<i>GATE₀</i>	: Gate input for 8254 Timer #0
<i>GATE</i>	: Gate input for 8254 Timer #1,2
<i>ExtRef_n</i>	: External Reference Voltage for D/A CH <i>n</i>
<i>DA_n</i>	: Analog Output Channel <i>n</i> (<i>n</i> =1,2)
REFout	: Internal Voltage Reference Output
5Vout	: Internal 5V Output
12Vout	: Internal 12V Output
A.GND	: Analog Ground
GND	: Ground

3.2 Analog Input Signal Connection

The PCI-9112 provides 16 single-ended or 8 differential analog input channels. The analog signal can be converted to digital value by the A/D converter. To avoid ground loops and get more accuracy measurement of A/D conversion, it is quite important to understand the signal source type and how to choose the analog input modes : signal-ended and differential. The PCI-9112 offers jumpers to select 16 single-ended or 8 different analog inputs.

Single-ended Mode :

The single-ended mode has only one input relative to ground and it suitable for connecting with the *floating signal source*. The floating source means it does not have any connection to ground. Figure 3.4 shows the single-ended connection. Note that when more than two floating sources are connected, the sources must be with common ground.

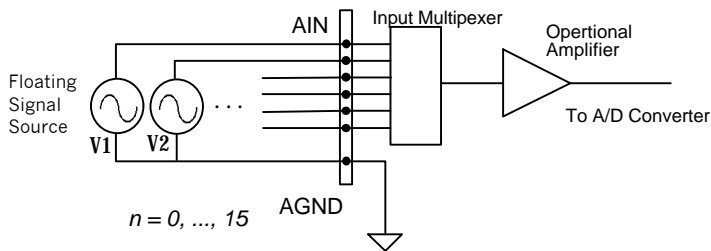

Figure 3.4 Floating source and single-ended

Differential input mode

The differential input mode provides two inputs that respond to the difference signal between them. If the signal source has one side connected to local ground, the differential mode can be used for reducing ground loop. Figure 3.5 shows the connection of the differential input mode. However, even if the signal source is local grounded, the single-ended still can be used when the V_{cm} (Common Mode Voltage) is very small and the effect of ground loop can be negated.

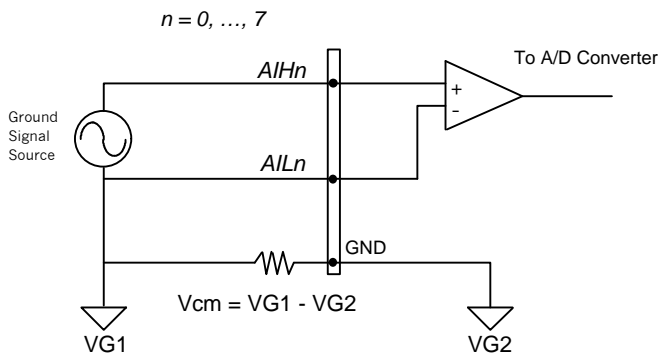

Figure 3.5 Ground source and differential input

A differential mode must be used when the signal source is differential. A differential source means the ends of the signal are not grounded. To avoid the danger of high voltage between the local ground of signal and the ground of the PC system, a shorted ground path must be connected. Figure 3.6 shows the connection of differential source.

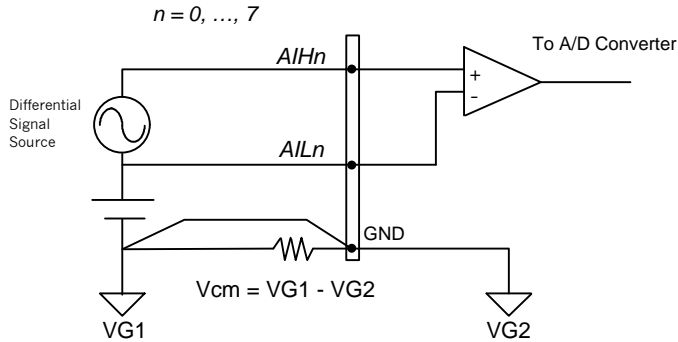

Figure 3.6 Differential source and differential input

If your signal source is both floating and local ground, you should use the differential mode, and the floating signal source should be connected as the Figure 3.7 .

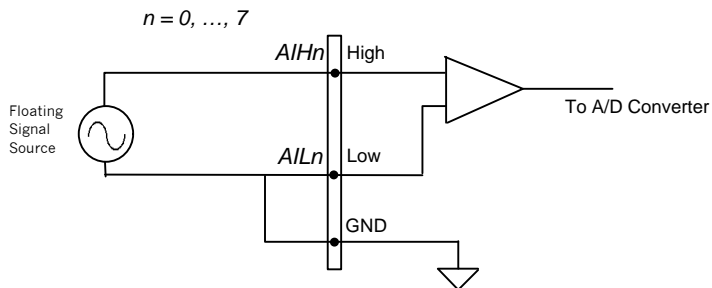

Figure 3.7 Floating source and differential input

3.3 Analog Output Signal Connection

The PCI-9112 has two unipolar analog output channels. To make the D/A output connections from the appropriate D/A output, please refer Figure 3.8.

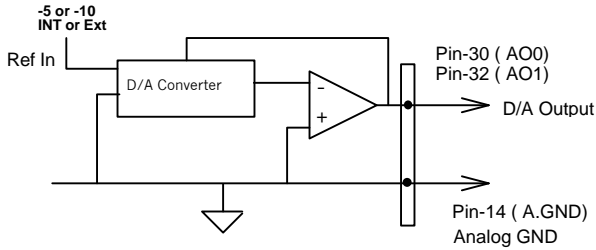

Figure 3.8 Connection of Analog Output Connection

3.4 Digital I/O Connection

The PCI-9112 provides 16 digital input and 16 digital output channels through the connector CN1 and CN2 on board. The digital I/O signal are fully TTL/DTL compatible. The detailed digital I/O signal specification can be referred in section 1.3.

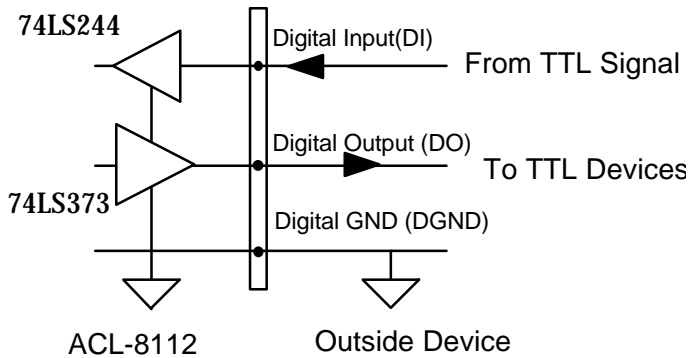

Figure 3.9 Digital I/O Connection

3.5 Timer / Counter Connection

The PCI-9112 has an interval timer/counter 8254 on board. It offers 3 independent 16-bit programmable down counters; counter 1 and counter 2 are cascaded together for A/D timer pacer trigger of A/D conversion, and counter 0 is free for your applications. Figure 3.10 shows the 8254 timer/counter connection.

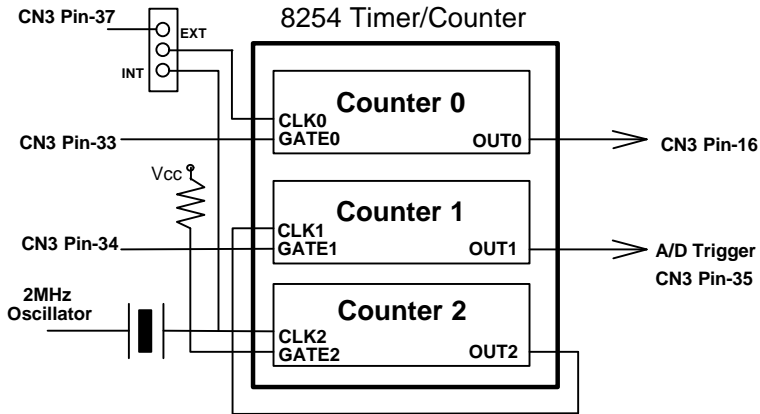

Figure 3.10 Block Diagram of 8254 Timer/Counter

The clock source of counter 0 can be internal or external, while the gate can be controlled externally and the output is send to the connector CN3. As to counter 0 and counter 1, the clock source is internally fixed, while the gate can be controlled externally and the output is send to the connector CN3 too. All the timer/ counter signals are TTL compatible.

3.6 Daughter Board Connection

The PCI-9112 can be connected with five different daughter boards, ACLD-8125, 9137, 9138, 9182, 9185, and 9188. The functionality and connections are specified in the following sections.

The cPCI-9112 is equipped with 100 pin SCSI-II type connector, the DIN-100S is a general purpose terminal board for connecting the external devices.

3.6.1 Connect with ACLD-8125

The ACLD-8125 has a 37-pin D-sub connector, which can connect with PCI-9112 through 37-pin assemble cable. The most outstanding feature of this daughter board is a CJC (cold junction compensation) circuit on board. You can directly connect the thermocouple on the ACL-8125 board. The CJC only suitable for High Gain version board.

3.6.2 Connect with ACLD-9137

The ACLD-9137 is a direct connector for the card which is equipped with 37-pin D-sub connector. This board provides a simple way for connection. It is very suitable for the simple applications that do not need complex signal condition before the A/D conversion is performed.

3.6.3 Connect with ACLD-9182

The ACLD-9182 is a 16 channel isolated digital input board. This board is connected with CN1 of PCI-9112 via 20-pin flat cable. The advantage of board is a 500Vdc isolation voltage is provided, and it can protect your PC system from damage when an abnormal input signal is occurred.

3.6.4 Connect with ACLD-9185

The ACLD-9185 is a 16 channel SPDT relay output board. This board is connected with CN2 of PCI-9112 via 20-pin flat cable. by using this board, you can control outside device through the digital output signals.

3.6.5 Connect with ACLD-9138 and ACLD-9188

ACLD-9138 and ACLD-9188 are general purpose terminal boards for all the card which comes equipped with 37-pin D-sub connector. The ACLD-9138 has a LED indicator to show the power ON/OFF of your computer system.

4

Register Format

The detailed descriptions of the register format and structure of the PCI-9112 are specified in this chapter. This information is quite useful for the programmer who wish to handle the card by low-level program.

In addition, the low level programming syntax is introduced. This information can help the beginners to operate the PCI-9112 in the shortest learning time.

4.1 I/O Port Address

The PCI-9112 functions as 32-bit PCI target device to any master on the PCI bus. It supports burst transfer to memory space by using 32-bit data. So, all data read and write will base on 32-bit data. The Table 4.1 shows the I/O address of each register with respect to the base address. The function of each register also be shown.

I/O Address	Read	Write
Base + 0	Counter 0	Counter 0
Base + 4	Counter 1	Counter 1
Base + 8	Counter 2	Counter 2
Base + C	-----	8254 Counter Control
Base + 10	A/D Data Reg.	CH1 D/A Data Reg.
Base + 14	-----	CH2 D/A Data Reg.
Base + 18	A/D Status Reg.	A/D Control Reg.
Base + 1C	Digital IN Reg.	Digital OUT Reg.
Base + 20	-----	Software Trigger

Table 4.1 I/O Address

4.2 A/D Data Registers

The PCI-9112 provides 16 single-ended or 8 differential A/D input channels, the digital data will store in the A/D data registers. The 12 bits A/D data is put into 32 bits registers.

Address : BASE + 10

Attribute : read only

Data Format :

Bit	7	6	5	4	3	2	1	0
BASE+10	AD3	AD2	AD1	AD0	CH3	CH2	CH1	CH0
BASE+11	AD11	AD10	AD9	AD8	AD7	AD6	AD5	AD4
BASE+12	---	---	---	---	---	---	---	---
BASE+13	---	---	---	---	---	---	---	---

AD11 .. AD0 : Analog to digital data. AD11 is the Most Significant Bit (MSB). AD0 is the Least Significant Bit (LSB).

CH3 ~ CH0 : A/D channel number from which the data is derived.

--- : Don't care

4.3 D/A Output Register

The D/A converter will convert the D/A output register data to the analog signal. The register data of the address Base+10 is used for D/A channel 1, Base+14 is used for D/A channel 2.

Address : BASE + 10

Attribute : write only

Data Format : (for D/A Channel 1)

Bit	7	6	5	4	3	2	1	0
Base + 10	DA7	DA6	DA5	DA4	DA3	DA2	DA1	DA0
Base + 11	---	---	---	---	DA11	DA10	DA9	DA8
Base + 12	---	---	---	---	---	---	---	---
Base + 14	---	---	---	---	---	---	---	---

Address : BASE + 14

Attribute : write only

Data Format : (for D/A Channel 2)

Bit	7	6	5	4	3	2	1	0
Base + 14	DA7	DA6	DA5	DA4	DA3	DA2	DA1	DA0
Base + 15	---	---	---	---	DA11	DA10	DA9	DA8
Base + 16	---	---	---	---	---	---	---	---
Base + 17	---	---	---	---	---	---	---	---

DA0 is the LSB and DA11 is the MSB of the 12 bits data.

--- : don't care

4.4 A/D control Register

This register is used to control the A/D channels to be converted. It's a write only register. When the channel number is written to the register, the multiplexer switches to the new channel and await for conversion.

Address : BASE + 18

Attribute : write only

Data Format :

Bit	7	6	5	4	3	2	1	0
Base + 18	MUX			Auto-Scan	A/D Mode			
Base + 19	---	---	---	GAIN				MUX
Base + 1A	---	---	---	---	---	---	---	---
Base + 1B	---	---	---	---	---	---	---	---

· **A/D Mode** :

Bit 3	Bit 2	Bit 1	Bit 0
EITS	TSTS	INTX	DMAX

EITS : External / Internal Trigger Source

1 : External Trigger Source

0: Internal Trigger Source

TPST : Timer Pacer/ Software Trigger

1 : Timer Pacer Trigger

0 : Software Trigger

(It is only available when the Internal Trigger Source is selected)

INTX: Interrupt Transfer Mode

1 : Enable Interrupt Transfer

0 : Disable Interrupt Transfer

DMAX : DMA Transfer Mode (bus mastering)

1 : Enable DMA Data Transfer

0 : Disable DMA Data Transfer

Only below modes are legal to be applied on the PCI-9112 card :

Bit 3 EITS	Bit 2 TPST	Bit 1 INTX	Bit 0 DMAX	Mode Description
0	0	0	0	Software Trigger & Polling
0	1	0	1	Timer Pacer Trigger & DMA
0	1	1	0	Timer Pacer Trigger & INT
1	X	0	0	External Trigger & Polling
1	X	0	1	External Trigger & DMA
1	X	1	0	External Trigger & INT

· **Auto-Scan : (Bit 4)**

0 : Auto Scan is disabled

Only channel [M3 M2 M1 M0] is converted only

1 : The converted channel will be selected by the sequence [M3 M2 M1 M0] to 0, for example, the MUX register is [0110] and the auto-scan bit is enabled, then the channel scan sequence is :

CH6, CH5, CH4, CH3, CH2, CH1, CH0, CH6, CH5, ...

· **MUX Register : (Bit8 ~ Bit5)**

The converted A/D channel is controlled by the register MUX, the format of MUX is show as table below.

Bit 8 M3	Bit 7 M2	Bit 6 M1	Bit 5 M0	Channel No.
0	0	0	0	CH0
0	0	0	1	CH1
0	0	1	0	CH2
...
1	1	1	0	CH14
1	1	1	1	CH15

Note :Single-ended mode : channel is selected from **CH0 ~ CH15**.Differential mode : channel is selected from **CH0 ~ CH7**.**Gain : (Bit12 ~ Bit9)**

In PCI-9112, the analog input ranges are software programmable and it is controlled by the gain value. The gain value and its corresponding input range is shown as below.

(Bit12) G3	(Bit11) G2	(Bit10) G1	(Bit9) G0	Bipolar or Unipolar	Input Range
1	0	0	0	Bipolar	±10V
0	0	0	0	Bipolar	±5V
0	0	0	1	Bipolar	±2.5V
0	0	1	0	Bipolar	±1.25V
0	0	1	1	Bipolar	±0.625V
0	1	0	0	Unipolar	0V ~ 10V
0	1	0	1	Unipolar	0V ~ 5V
0	1	1	0	Unipolar	0V ~ 2.5V
0	1	1	1	Unipolar	0V ~ 1.25V

4.5 A/D Status Register

Address : BASE + 18**Attribute** : read only**Data Format** :

Bit	7	6	5	4	3	2	1	0
Base + 18	---	---	---	---	---	---	DOVR	DRDY
Base + 19	---	---	---	---	---	---	---	---
Base + 1A	---	---	---	---	---	---	---	---
Base + 1B	---	---	---	---	---	---	---	---

DOVR : A/D Over-Run (it is only when A/D is transferred by DMA bus

master mode.)

1 : A/D converted Data is over run

0 : A/D converted Data is in normal condition

DRDY : A/D Data is Ready

1 : A/D conversion is completed

0 : A/D conversion is not completed

4.6 Software Trigger Register

If you want to generate a trigger pulse to the PCI-9112 for A/D conversion, you just write any data to this register, and then the A/D converter will be triggered.

Address : **BASE + 20**

Attribute : write only

Data Format :

Bit	7	6	5	4	3	2	1	0
BASE+20	X	X	X	X	X	X	X	X

4.7 Digital I/O register

There are 16 digital input channels and 16 digital output channels provided by the PCI-9112. The address Base + 1C is used to access digital inputs and control digital outputs.

Address : **BASE + 1C**

Attribute : read only

Data Format :

Bit	7	6	5	4	3	2	1	0
Base + 1C	DI7	DI6	DI5	DI4	DI3	DI2	DI1	DI0
Base + 1D	DI15	DI14	DI13	DI12	DI11	DI10	DI9	DI8
Base + 1E	---	---	---	---	---	---	---	---
Base + 1F	---	---	---	---	---	---	---	---

Address : BASE + 1C

Attribute : write only

Data Format :

Bit	7	6	5	4	3	2	1	0
Base + 1C	DO7	DO6	DO5	DO4	DO3	DO2	DO1	DO0
Base + 1D	DO15	DO14	DO13	DO12	DO11	DO10	DO9	DO8
Base + 1E	---	---	---	---	---	---	---	---
Base + 1F	---	---	---	---	---	---	---	---

4.8 Internal Timer/Counter Register

Two counters of 8254 are used for periodically triggering the A/D conversion, the left one is left free for user applications. The 8254 occupies 4 I/O address locations in the PCI-9112 as shown blow. Users can refer to NEC's or Intel's data sheet for a full description of the 8254 features.

Address : BASE + 0 ~ BASE + F

Attribute : read / write

Data Format :

Base + 0	Counter 0 Register (R/W)
Base + 4	Counter 1 Register (R/W)
Base + 8	Counter 2 Register (R/W)
Base + C	8254 CONTROL BYTE (W)

4.12 High Level Programming

To operate the PCI-9112, you can by-pass the detailed register structures and control your PCI-9112 card directly via the high-level Application-Programming-Interface (API). The software Libraries, including DOS Library for Borland C++ and DLL driver for Windows-95/98, are included in the CD. For more detailed information, please refer to Chapter 6 “C/C++ Software Library”.

4.13 Low Level Programming

To operate the PCI-9112, users do not need to understand how to write a hardware dependent low-level program. Because it is more complex to control the PCI controller and the information is not described in this manual. We do not recommend users to program its applications based on low-level programming. The PCI controller used in the PCI-9112 is AMCC-S5933. For more s5933 PCI controller information, please visit the web site: www.amcc.com.

5

Operation Theorem

The operation theorem of the functions on PCI-9112 card is described in this chapter. The functions include the A/D conversion, D/A conversion, Digital I/O and counter / timer. The operation theorem can help you to understand how to manipulate or to program the PCI-9112.

5.1 A/D Conversion

Before programming the PCI-9112 to perform the A/D conversion, you should understand the following issues:

- **A/D conversion procedure**
- **A/D trigger mode**
- **A/D data transfer mode**
- **Signal Connection**

5.1.1 A/D Conversion Procedure

The A/D conversion is starting by a trigger source, then the A/D converter will start to convert the signal to a digital value. The PCI-9112 provides three trigger modes, see section 5.1.2.

While A/D conversion, the *DRDY* bit in *A/D status register* is cleared to indicate the data is not ready. After conversion being completed, the *DRDY* bit will return to high(1) level. It means users can read the converted data from the A/D data registers. Please refer section 4.5 for the A/D status register format.

The A/D data should be transferred into PC's memory for further using. The PCI-9112 provides three data transfer modes that allow users to optimize the DAS system. Refer to section 5.1.3 for data transfer modes.

5.1.2 A/D Trigger Modes

In the PCI-9112, A/D conversion can be triggered by the *Internal* or *External* trigger source. The EITS bit of A/D control register is used to select the internal or external trigger, please refer to section 4.5 for details. Whenever the external source is set, the internal sources are disable.

If the internal trigger is selected, there are two internal sources, the software trigger and the timer pacer trigger can be used. The A/D operation mode is controlled by A/D mode bits (EITS, TSTS) of A/D control register (BASE+18). Total three trigger sources are possible in the PCI-9112. The different trigger conditions are specified as follows:

Software trigger

The trigger source is software controllable in this mode. That is, the A/D conversion is starting when any value is written into the software trigger register (BASE+20). This trigger mode is suitable for low speed A/D conversion. Under this mode, the timing of the A/D conversion is fully controlled under software. However, it is difficult to control the fixed A/D conversion rate except another timer interrupt service routine is used to generate a fixed rate trigger.

Timer Pacer Trigger

An on-board timer / counter chip 8254 is used to provide a trigger source for A/D conversion at a fixed rate. Two counters of the 8254 chip are cascaded together to generate trigger pulse with precise period. Please refer to section 5.4 for 8254 architecture. This mode is ideal for high speed A/D conversion. It can be combined with the DMA bus mastering or the interrupt data transfer. It's recommend to use this mode if your applications need a fixed and precise A/D sampling rate.

External Trigger

Through the pin-17 of CN3 (*ExtTrig*), the A/D conversion also can be performed when a rising edge of external signal is occurred. The conversion rate of this mode is more flexible than the previous two modes, because the users can handle the external signal by outside device. The external trigger can combine with the DMA transfer, interrupt data transfer, or even program polling data transfer. Generally, the interrupt data transfer is often used when external trigger mode is used.

5.1.3 A/D Data Transfer Modes

On the PCI-9112, three A/D data transfer modes can be used when the conversion is completed. The data transfer mode is controlled by the A/D mode control bits (INTX, DMAX) of the A/D control register (BASE+18). The different transfer modes are specified as follows:

Software Data Transfer (DRDY)

Usually, this mode is used with software A/D trigger mode. After the A/D conversion is triggered by software, the software should poll the *DRDY* bit on the A/D Status register until it becomes to high level. Whenever the low byte of A/D data is read, the *DRDY* bit will be cleared to indicate the data is read out.

It is possible to read A/D converted data without polling. The A/D conversion time will not excess 8 μ s on PCI-9112 card. Hence, after software trigger, the software can wait for at least 8 μ s then read the A/D register without polling.

Interrupt Transfer (INTX)

The PCI-9112 provides hardware interrupt capability. Under this mode, an interrupt signal is generated when the A/D conversion is ended and the data is ready to be read. It is useful to combine the interrupt transfer with the timer pacer trigger mode. Under this mode, the data transfer is essentially asynchronous with the control software.

When the interrupt transfer is used, the hardware interrupt will be inserted and its corresponding ISR (Interrupt Service Routine) will be invoked and executed after A/D conversion is completed. The converted data is transferred by the ISR program. In PCI design, the IRQ level is assigned by BIOS directly.

DMA Transfer (DMAX)

The DMA (Direct Memory Access) bus master allows data to be transferred directly between the PCI-9112 and the PC memory at the fastest possible rate, without using any CPU time. The A/D data will be queue at local FIFO on the PCI-9112 itself and it is automatically transferred to PC's memory.

The DMA transfer mode is very complex to program. It is recommended to use the high level program library to operate this card. If you wish to program the software which can handle the DMA bus master data transfer, please refer to more information about PCI controller.

5.2 D/A Conversion

The operation of D/A conversion is more simple than A/D operation. You only need to write Digital values into the D/A data registers and the corresponding voltage will be output from the AO1 or AO2. Refer to section 4.3 for information about the D/A data registers. The mathematical relationship between the Digital number DAn and the output voltage is formulated as following:

$$V_{out} = -V_{ref} \times \frac{DAn}{4096}$$

where the V_{ref} is the reference voltage, the V_{out} is the output voltage, and the DAn is the Digital value in D/A data registers.

Before performing the D/A conversion, users should care about the D/A reference voltage which set by the JP3 and JP4. Please refer section 2.8 for jumper setting. The reference voltage will effect the output voltage. If the reference voltage is -5V, the D/A output scaling will be 0~5V. If the reference voltage is -10V, the D/A output scaling will be 0~10V.

5.3 Digital Input and Output

To program digital I/O operation is fairly straight forward. The digital input operation is just to read data from the corresponding registers, and the digital output operation is to write data to the corresponding registers. The digital I/O registers' format are shown in section 4.7. Note that the DIO data channel can only be read or written in form of 16 bits together. It is impossible to access individual bit channel.

5.4 Timer/Counter Operation

The PCI-9112 has an interval timer/counter 8254 on board. Refer to section 3.5 for the signal connection and the configuration of the counters.

The 8254 Timer / Counter Chip

The Intel (NEC) 8254 contains three independent, programmable, multi-mode 16 bit counter/timers. The three independent 16 bit counters can be clocked at rates from DC to 5 MHz. Each counter can be individually programmed with 6 different operating modes by appropriately formatted control words. The most commonly uses for the 8254 in microprocessor based system are:

- programmable baud rate generator
- event counter
- binary rate multiplier
- real-time clock
- Digital one-shot
- motor control

For more information about the 8254, please refer to the NEC Microprocessors and peripherals or Intel Microsystems Components Handbook.

Pacer Trigger Source

The counter 1 and counter 2 are cascaded together to generate the timer pacer trigger of A/D conversion. The frequency of the pacer trigger is software controllable. The maximum pacer signal rate is $2\text{MHz}/4=500\text{K}$ which exceeds the maximum A/D conversion rate of the PCI-9112. The minimum signal rate is $2\text{MHz}/65536/65536$, which is a very slow frequency that user may never use it.

General Purpose Timer/ Counter

The counter 0 is free for users' applications. The clock source, gate control signal and the output signal is send to the connector CN3. The general purpose timer / counter can be used as event counter, or used for measuring frequency, or others functions.

I/O Address

The 8254 in the PCI-9112 occupies 4 I/O address as shown below.

BASE + 0	LSB OR MSB OF COUNTER 0
BASE + 1	LSB OR MSB OF COUNTER 1
BASE + 2	LSB OR MSB OF COUNTER 2
BASE + 3	CONTROL BYTE

The programming of 8254 is control by the registers BASE+0 to BASE+3. The functionality of each register is specified this section. For more detailed information, please refer handbook of 8254 chip.

Control Byte

Before loading or reading any of these individual counters, the control byte (BASE+3) must be loaded first. The format of the control byte is :

Bit	7	6	5	4	3	2	1	0
	SC1	SC0	RL1	RL0	M2	M1	M0	BCD

- SC1 & SC0 - Select Counter (Bit7 & Bit 6)

SC1	SC0	COUNTER
0	0	Select Counter 0
0	1	Select Counter 1
1	0	Select Counter 2
1	1	ILLEGAL

- RL1 & RL0 - Select Read/Load operation (Bit 5 & Bit 4)

RL1	RL0	OPERATION
0	0	COUNTER LATCH FOR STABLE READ
0	1	READ/LOAD LSB ONLY
1	0	READ/LOAD MSB ONLY
1	1	READ/LOAD LSB FIRST, THEN MSB

- M2, M1 & M0 - Select Operating Mode (Bit 3, Bit 2, & Bit 1)

M2	M1	M0	MODE
0	0	0	0
0	0	1	1
x	1	0	2
x	1	1	3
1	0	0	4
1	0	1	5

- BCD - Select Binary/BCD Counting (Bit 0)

0	16-BITS BINARY COUNTER
1	BINARY CODED DECIMAL (BCD) COUNTER (4 DIGITAL)
Note	The count of the binary counter is from 0 up to 65,535 and the count of the BCD counter is from 0 up to 9,999

Mode Definitions

In 8254, six operating modes can be selected. They are :

- **Mode 0** : Interrupt on Terminal Count
- **Mode 1** : Programmable One-Shot.
- **Mode 2** : Rate Generator.
- **Mode 3** : Square Wave Rate Generator.
- **Mode 4** : Software Triggered Strobe.
- **Mode 5** : Hardware Triggered Strobe.

All detailed description of these six modes are written in Intel Microsystems Components Handbook Volume II Peripherals.

6

Calibration & Utilities

In data acquisition process, how to calibrate your measurement devices to maintain its accuracy is very important. Users can calibrate the analog input and analog output channels under the users' operating environment for optimizing the accuracy. This chapter will guide you to calibrate your PCI-9112 to an accuracy condition.

6.1 What do you need

Before calibrating your PCI-9112 card, you should prepare some equipments for the calibration:

- **Calibration program** : Once the program is executed, it will guide you to do the calibration. This program is included in the delivered package.
- **A 5 1/2 digit multimeter (6 1/2 is recommended)**
- **A voltage calibrator or a very stable and noise free DC voltage generator.**

6.2 VR Assignment

There are five variable resistors (VR) on the PCI-9112 board to allow you making accurate adjustment on A/D and D/A channels. The function of each VR is specified as Table 7.1.

VR1	A/D bipolar offset adjustment
VR2	A/D full scale adjustment
VR3	D/A channel 1 full scale adjustment
VR4	D/A channel 2 full scale adjustment
VR5	A/D unipolar offset adjustment
VR6	D/A reference voltage adjustment
VR7	A/D programmable amplifier offset adjustment

Table 7.1 Function of VRs

6.3 A/D Adjustment

6.3.1 Bipolar Calibration

1. Set the analog input range as : +/- 5V, i.e. the gain = 1 and input mode = Bipolar.
2. Short the A/D channel 0 (pin 1 of CN3) to ground (GND), and connect the TP1 (+) and TP2 (-) with your DVM. Trim the variable resistor **VR7** to obtain a value as close as possible to 0V.
3. Apply a +5V input signal to A/D channel 0, and trim the **VR2** to obtain reading between 4094~4095.
4. Apply a +0V input signal to A/D channel 0, and trim the **VR1** to obtain reading flickers between 2048~2049.
5. Repeat step 3 and step 4, adjust **VR2** and **VR1**.

6.3.2 Unipolar Calibration

1. Set the analog input range as : 0 ~ 10 V, i.e. the gain = 1 and input mode = Unipolar.
2. Short the A/D channel 0 (pin 1 of CN3) to ground (GND) and connect TP1 (+) and TP2 (-) with your DVM. Trim the **VR5** to -5V reading in the DVM.

6.4 D/A Adjustment

There are two steps to calibrate the analog output channels, D/A 1 and D/A 2. The first step is to adjust the reference voltage, and the second step is to adjust each channel of D/A.

6.4.1 Reference Voltage Calibration

1. Set reference voltage as -5V (the D/A reference voltage is selected by JP3, see section 2.8).
2. Connect VDM (+) to CN3 pin-11 (V.REF) and VDM (-) to GND.
Trim the variable resistor **VR6** to obtain -5V reading in the DVM.

Note: If the reference voltage set as -10V, the connection is the same as -5V, but the reading from DVM should be -10V.

6.4.2 D/A Channel Calibration

D/A CH1 calibration

1. Connect VDM (+) to CN3 pin-30 (AO1) and VDM (-) to A.GND.
2. Write the Digital value 0x0FFF into registers (BASE+ 10)
3. Trim the variable resistor VR3 to obtain +5V reading in the DVM.

D/A CH2 calibration

1. Connect VDM (+) to CN3 pin-32 (AO2) and VDM (-) to A.GND.
2. Write the Digital value 0x0FFF into registers (Base + 14)
3. Trim the variable resistor VR4 to obtain +5V reading in the DVM.

A calibration utility is supported in the software CD which is included in the product package. The detailed calibration procedures and description can be found in the utility. Users only need to run the software calibration utility and follow the procedures. You will get the accurate measure data.

In normal condition, the PCI-9112 already calibrated by factor before it is shipped out. So, users do not need to calibrate your PCI-9112 when you get it.

7

Software Utility and Library

The PCI-9112 come equipped with their own software utility and C language library which simplifies your programming efforts and speed up your software developing.

The PCI-9112 is a PCI-based high performance multi-function data acquisition card, which provides 16 single-ended analog or 8 differential analog inputs and auto scan channel by hardware, two double-buffered multiplexing analog outputs. In addition to analog I/O, 16 digital inputs and outputs and three 16-bit timer/counter channels are also included in the board.

The utility program in the software package includes System Configuration, Calibration, and Functional testing. All the utilities are using menu-driven operating mode based on windowing environment, so it is very easy to operate and no more learning effort.

There are 29 C-language API (Application Programming Interface) functions and DLL libraries for Win-95 in this software package. It supports users to program their own software applications in different operating environment, such as DOS and Windows 95.

The functionality of these function calls can be classified to the following capabilities,

- 1. Initialization : get the hardware configuration**
- 2. A/D conversion : performs analog to digital conversion (one-shot and continuous)**
- 3. D/A conversion : performs digital to analog conversion**
- 4. Digital I/O : input or output digital signals**
- 5. Timer/Counter : provides frequency measures, event counting, etc.**

In addition to the Utility and C/C++, DLL Libraries, some demonstration programs are also included; users can refer them and save a lot of programming time and get some other benefits as well.

7.1 Installation

The PCI-9112's Software Library includes a utility software, C-language library, DLL libraries and some demonstration programs which can help you reduce programming work and support the calibration of analog inputs and outputs.

The installation on different O.S. platforms should follow different procedures. The installation procedures are classified to three O.S..

7.1.1 MS-DOS Installation :

The procedures should be followed as :

1. Turn your PC's power switch on
2. Place ADLink's "Manual & Software Utility" CD into the appropriate CD driver
3. Type the command (X indicates the CD ROM driver):

```
X:\> CD Software\NuDAQPCI\9112\DOS  
X:\Software\NuDAQPCI\9112\DOS> SETUP
```

4. An installation complete message will be shown on the screen.

After installation, all the files of *PCI-9112 Library & Utility for DOS* are stored in C:\ADLink\9112\dos directory.

7.1.2 Windows 95 DLL Installation:

1. Place ADLink's "Manual & Software Utility" CD into the appropriate CD driver.
2. If Windows 95 is loaded, choose Run from the Start menu.
3. Type **X:\Software\NuDAQPCI\9112\Win95\Setup.exe** in the Run dialog box. (X indicates the CD ROM driver).

After a welcome dialog box, Setup prompts the following dialog box for you to specify the destination directory. The default path is C:\ADLink\9112\W95. If you want to install *PCI-9112 DLL for Windows*

95 in another directory, please click Browse button to change the destination directory.

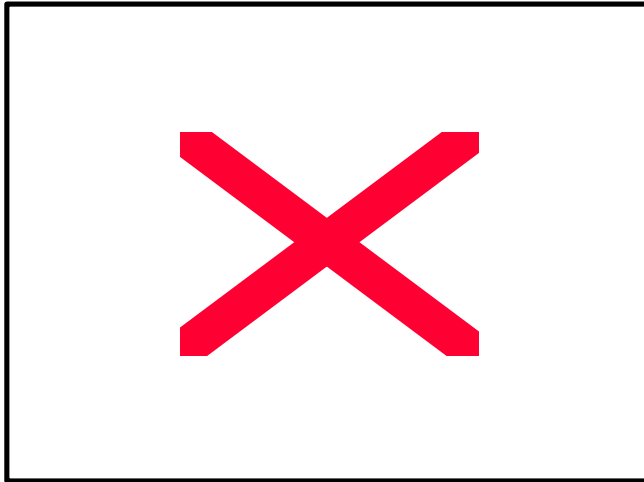

Then you can click Next to begin installing *PCI-9112 DLL for Windows 95*.

After you complete the installation of PCI-9112 Software, PCI-9112's DLL (9112.DLL) is copied to Windows System directory (default is C:\WINDOWS\SYSTEM for Win-95) and the driver files (W95_9112.VXD and PCIW95.VXD) are also copied to the appropriate directory.

7.2 Software Utility

There are three functions provided by PCI-9112's utility software, they are System Configuration, Calibration, and Functional Testing. This utility software is designed by menu-driven based on windowing environment. Not only the text messages are shown for operating guidance, but also has the graphic to indicate you how to set right hardware configuration.

7.2.1 Running the Utility

After finishing the installation, you can execute the utility by typing as follows :

```
C> cd \ADLINK\9112\DOSUTIL
C> 9112UTIL
```

7.2.2 System Configuration

This function is used to guide you how to install the PCI-9112 card, and set the right hardware configuration.

The top window shows the setting items that you have to set before using the PCI-9112 card. The bottom window gives you a layout of PCI-9112; the jumpers and DIP switch are shown on it. Whenever you change the attribute of each setting, its corresponding jumper will be update immediately. You could follow this indication to change the jumper setting on your PCI-9112 board.

The following diagram will be displayed on the screen as you choose the Configuration Setup function from main menu.

7.2.3 Calibration

This function is used to guide you how to calibrate the PCI-9112. The calibration program serves as a useful test of the PCI-9112's A/D and D/A functions and can aid in troubleshooting if problems arise.

Note : For an environment with frequently large changes of temperature and vibration, a 3 months re-calibration interval is recommended. For laboratory conditions, 6 months to 1 year is acceptable

When you choose the calibration function from the main menu list, a diagram shown below is displayed on the screen, the upper window shows the calibration items, such as DAC channel 1 or channel 2 full range adjust, Gain Amplifier offset adjust. etc.

The bottom window shows the detailed procedures should be followed when you proceed the calibration. The instructions will guide you to calibrate each item step by step.

7.2.4 Functional Testing

This function is used to test multi-function of PCI-9112, it includes Digital I/O testing, D/A testing, A/D testing, Timer Testing, and DMA testing.

When you choose the test function from the main menu list, a diagram shown below is displayed on the screen, the upper window shows the testing items, and the bottom window shows the testing results.

7.3 C/C++ & DLL Library

There are 29 function calls provided by the C/C++ Language and Windows DLL Library. The functions of PCI-9112 are covered by these libraries, including A/D conversion, D/A conversion, Digital Input and Output, etc.

Using the C Language library saves a lot of programming time and has some other benefits as well. The library also supports data collection on interrupt or DMA from internal time clock for A/D conversion.

Several demonstration programs are included in this CD. It will help you to understand the library more quickly. The detailed description of each function in the library is specified in the following sections.

7.3.1 `_9112_Initial`

@ **Description**

A PCI-9112 card is initialized according to the card number. Because the PCI-9112 is PCI bus architecture and meets the plug and play design, the **IRQ** and **base_address** (pass-through address) are assigned by system BIOS directly. Every PCI-9112 card has to be initialized by this function before calling other functions.

Note : Because configuration of PCI-9112 is handled by the system, there is no jumpers or DMA selection on the PCI boards that need to be set up by the users.

@ **Syntax**

Visual C++ (Win-95)
`int W_9112_Initial (int card_number, int *base_address, int *irq_no)`

Visual Basic (Win-95)
`W_9112_Initial (ByVal card_number As Long, base_address As Long, irq_no As Long) As Integer`

C/C++ (DOS)
`int _9112_Initial (int card_number, int *base_address, int *irq_no)`

@ **Argument :**

card_number : the card number to be initialized, only four cards can be initialized, the card number must be `CARD_1`, `CARD_2`, `CARD_3`, or `CARD_4`.

base_address : the I/O port base address of the card, it is assigned by system BIOS.

irq_no : system will give an available interrupt number to this card automatically.

@ **Return Code :**

<code>ERR_NoError,</code>	<code>ERR_InvalidBoardNumber</code>
<code>ERR_PCIBiosNotExist,</code>	<code>ERR_PCICardNotExist</code>
<code>ERR_PCIIrqNotExist</code>	

@ **Example :**

```
#include "9112.h"
```

```

main()
{
    int    errCode;
    int    baseAddr1, irqNo1;
    int    baseAddr2, irqNo2;

    errCode = _9112_Initial( CARD_1, &baseAddr1, &irqNo1);
    if ( errCode != ERR_NoError )
        exit(0);

    errCode = _9112_Initial( CARD_2, &baseAddr2, &irqNo2);
    if ( errCode != ERR_NoError )
        exit(0);
}

```

7.3.2 _9112_DI

@ **Description**

This function is used to read data from digital input port. There are 16-bit digital inputs on the PCI-9112. You can get all 16 input data from _9112_DI one shot.

@ **Syntax**

Visual C++ (Win-95)

```
int W_9112_DI (int card_number, unsigned int *di_data)
```

Visual Basic (Win-95)

```
int W_9112_DI (ByVal card_number As Long, di_data As Long) As Long
```

C/C++ (DOS)

```
int _9112_DI (int card_number, unsigned int *di_data)
```

@ **Argument :**

card_number : the card number of PCI-9112

di_data : return all 16-bit value from digital port.

@ **Return Code :**

ERR_NoError, ERR_BoardNoInit

@ **Example :**

See Appendix A . Demo Program 'DIO_DEMO.C'

7.3.3 _9112_DI_Channel

@ **Description**

This function is used to read data from digital input channels (bit). There are 16 digital input channels on the PCI-9112. When performs this function, the digital input port is read and the value of the corresponding channel is returned.

** channel means each bit of digital input ports.*

@ **Syntax**

Visual C++ (Win-95)

```
int W_9112_DI_Channel (int card_number, int di_ch_no, unsigned int  
*di_data)
```

Visual Basic (Win-95)

```
W_9112_DI_Channel (ByVal card_number As Long, ByVal di_ch_no  
As Long, di_data As Long) As Integer
```

C/C++ (DOS)

```
int _9112_DI_Channel (int card_number, int di_ch_no, unsigned int  
*di_data)
```

@ **Argument :**

card_number : the card number of PCI-9112

di_ch_no : the DI channel number, the value has to be set
from 0 to 15.

di_data : return value, either 0 or 1.

@ **Return Code :**

ERR_NoError, ERR_BoardNoInit, ERR_InvalidDIChannel

@ **Example :**

```
#include "9112.h"
```

```
main()
```

```
{  
    unsigned int    data;  
    int ch;  
    int    baseAddr, irqNo;
```

```
    _9112_Initial( CARD_1, &baseAddr, &irqNo);  
    /* Assume NoError when Initialize PCI-9112 */  
    .
```

```

.
.
for( ch=0; ch<16; ch++ )
{
    _9112_DI_Channel(CARD_1, ch , &data );
    printf( "The value of DI channel %d is %d.\n" , ch , data );
}
}

```

7.3.4 `_9112_DO`

@ Description

This function is used to write data to digital output port. There are 16 digital outputs on the PCI-9112,

@ Syntax

Visual C++ (Win-95)

`int W_9112_DO (int card_number, unsigned int do_data)`

Visual Basic (Win-95)

`W_9112_DO (ByVal card_number As Long, ByVal do_data As Long) As Integer`

C/C++ (DOS)

`int _9112_DO(int card_number, unsigned int do_data)`

@ Argument :

card_number : the card number of PCI-9112

do_data : value will be written to digital output port

@ Return Code :

`ERR_NoError, ERR_BoardNoInit`

7.3.5 `_9112_DA`

@ Description

This function is used to write data to D/A converters. There are two Digital-to-Analog conversion channels on the PCI-9112. The resolution of each channel is 12-bit, i.e. the range is from 0 to 4095.

@ Syntax

Visual C++(Win-95)

```
int W_9112_DA (int card_number, int da_ch_no, unsigned int data)
```

Visual Basic (Win-95)

```
W_9112_DA (ByVal card_number As Long, ByVal da_ch_no As Long,  
ByVal da_data As Long) As Long
```

C/C++ (DOS)

```
int _9112_DA (int card_number, int da_ch_no, unsigned int data )
```

@ Argument :

card_number : the card number of PCI-9112
da_ch_no : D/A channel number, DA_CH_1 or DA_CH_2.
data : D/A converted value, if the value is greater than 4095, the higher bits are negligent.

@ Return Code :

ERR_NoError, ERR_BoardNoInit
ERR_InvalidDAChannel

@ Example :

```
#include "9112.h"  
  
main()  
{  
    Int    baseAddr, irqNo;  
  
    _9112_Initial( CARD_1, &baseAddr, &irqNo);  
    /* Assume NoError when Initialize PCI-9112 */  
  
    /* if the hardware setting for DA output range is 0~5V */  
  
    _9112_DA(CARD_1, DA_CH_1 , 0x800 );  
    printf( "The output voltage of CH1 is 2.5V \n" );  
  
    _9112_DA(CARD_1, DA_CH_2 , 0xFFFF );  
    printf( "The output voltage of CH2 is 5V \n" );  
  
}
```

A more complete program is specified in Appendix A Demo. Program 'DA_DEMO.C'

7.3.6 `_9112_AD_Set_Channel`

@ **Description**

This function is used to set AD channel by means of writing data to the multiplexed scan channel register. There are 16 single-ended or 8 differential analog input channels in PCI-9112, so the channel number should be set between 0 to 15 for signled-end analog input mode, and 0 to 7 for differnetial analog input mode. The initial state is channel 0 which is a default setting by the PCI-9112 hardware configuration.

@ **Syntax**

Visual C++ (Win-95)

```
int W_9112_AD_Set_Channel (int card_number, int ad_ch_no)
```

Visual Basic (Win-95)

```
W_9112_AD_Set_Channel (ByVal card_number As Long, ByVal  
da_ch_no As Long) As Long
```

C/C++ (DOS)

```
int _9112_AD_Set_Channel (int card_number, int ad_ch_no )
```

@ **Argument :**

card_number : the card number of PCI-9112
ad_ch_no : channel number to perform AD conversion
for single-ended mode : channel no. is from 0-15;
for differential mode : channel no. is from 0-7

@ **Return Code :**

ERR_NoError, ERR_BoardNoInit
ERR_InvalidADChannel

7.3.7 `_9112_AD_Set_Range`

@ **Description**

This function is used to set the A/D analog input range by means of writing data to the A/D range control register. There are two factors will change the analog input range - *Gain* and *Input type*.

The Gain can be choice from 0.5, 1, 2, 4, and 8 . The input type is either *Bipolar* or *Unipolar*.

The initial value of gain is '1' and input type is bipolar, which are pre-set by the PCI-9112 hardware. The relationship between analog input voltage range, gain and input mode are specified by following tables:

**** this table is suitable for PCI-9112 card.**

AD_INPUT	GAIN	Input type (Bipolar or Unipolar)	Input Range
AD_B_5_V	1	Bipolar	±5V
AD_B_2_5_V	2	Bipolar	±2.5V
AD_B_1_25_V	4	Bipolar	±1.25V
AD_B_0_625_V	8	Bipolar	±0.625V
AD_U_10_V	1	Unipolar	0V ~ 10V
AD_U_5_V	2	Unipolar	0V ~ 5V
AD_U_2_5_V	4	Unipolar	0V ~ 2.5V
AD_U_1_25_V	8	Unipolar	0V ~ 1.25V
AD_B_10_V	0.5	Bipolar	±10V

@ Syntax

Visual C++ (Win-95)

int W_9112_AD_Set_Range (int card_number, int ad_range)

Visual Basic (Win-95)

W_9112_AD_Set_Channel (ByVal card_number As Long, ByVal ad_range As Long) As Long

C/C++ (DOS)

int _9112_AD_Set_Range (int card_number, int ad_range)

@ Argument :

card_number : the card number of PCI-9112

ad_range : the programmable range of A/D conversion, please refer the the above table for the possible range values.

@ Return Code :

ERR_NoError

ERR_BoardNoInit

ERR_AD_InvalidRange

7.3.8 _9112_AD_Set_Mode

@ Description

This function is used to set the A/D trigger and data transfer mode by means of writing data to the mode control register. The hardware initial state of the PCI-9112 is set as AD_MODE_0 software (internal) trigger with program polling data. For more detailed description of DMA bus mastering mode is specified in section 4.13.

A/D Mode	Description
AD_MODE_0	Software Trigger, Software Polling
AD_MODE_1	Timer Trigger, Interrupt Transfer
AD_MODE_2	Timer Trigger, DMA (bus mastering)Transfer
AD_MODE_3	External Trigger, Software Polling
AD_MODE_4	External Trigger, Interrupt Transfer
AD_MODE_5	External Trigger, DMA (bus mastering) Transfer

@ Syntax

Visual C++ (Win-95)
int W_9112_AD_Set_Mode (int card_number, int ad_mode)

Visual Basic (Win-95)
W_9112_AD_Set_Mode (ByVal card_number As Long, ByVal ad_mode As Long) As Long

C/C++ (DOS)

int _9112_AD_Set_Mode (int card_number, int ad_mode)

@ Argument :

card_number : the card number of PCI-9112
ad_mode : AD trigger and data transfer mode
(please refer to above table.)

@ Return Code :

ERR_NoError
ERR_BoardNoInit
ERR_InvalidMode

@ Example :

```
#include "9112.h"  
main()  
{
```

```

Int      baseAddr, irqNo;

_9112_Initial( CARD_1, &baseAddr, &irqNo);
/* Assume NoError when Initialize PCI-9112 */

_9112_AD_Set_Range(CARD_1, AD_B_5_V );
printf( "The A/D analog input range is +/- 5V \n" );

_9112_AD_Set_Mode(CARD_1, AD_MODE_4 );
printf( "Now, The Internal Timer Pacer trigger is set \n" );

/* All A/D conversion will be trigger by internal timer pacer, and the
converted data should be transfered in the interrupt service routine.
( ISR). */
}

```

7.3.9 _9112_AD_Set_Autoscan

@ *Description*

This function is used to set automatic hardware channel scan to be enable or disable. If the PCI-9112 is set as enable mode, then the A/D channel can be converted automatically, that is, the hardware will automatically decrement until channel 0. And then, it will go back to channel which is set by `_9112_AD_Set_Channle` and wrap back to zero again. For example, the channel is set as 4, the A/D conversion sequence will be 4, 3, 2, 1, 0, 4, 3, 2, 1, 0, 4, 3, 2, 1, 0, 4, 3, 2, 1, 0, 4, 3,

If the autoscan is set as disable, the channel will be kept as single channel only, such as channel 4.

@ *Syntax*

Visual C++ (Win-95)

```
int W_9112_AD_Set_Autoscan (int card_number, int autoscan)
```

Visual Basic (Win-95)

```
int W_9112_AD_Set_Autoscan (ByVal card_number As Long, ByVal
autoscan As Long) As Long
```

C/C++ (DOS)

int _9112_AD_Set_Autoscan (int card_number, int autoscan)

@ Argument :

card_number : the card number of PCI-9112
autoscan : TRUE or FALSE

@ Return Code :

ERR_NoError, ERR_BoardNoInit

@ Example :

See the demo program 'AD_DEMO4.C'

7.3.10 _9112_AD_Soft_Trig**@ Description**

This function is used to trigger the A/D conversion by software. When the function is called, a trigger pulse will be generated and A/D conversion is started, and the converted data will be stored in the base address Base + 0x10 after the conversion.

@ Syntax

Visual C++ (Win-95)
int W_9112_AD_Soft_Trig (int card_number)

Visual Basic (Win-95)
W_9112_AD_Soft_Trig (ByVal card_number As Long) As Long

C/C++ (DOS)

int _9112_AD_Soft_Trig (int card_number)

@ Argument :

card_number : the card number of PCI-9112

@ Return Code :

ERR_NoError, ERR_BoardNoInit

7.3.11 _9112_AD_Aquire

@ **Description**

This function is used to poll the AD conversion data. It will trigger the AD conversion, and read the 12-bit A/D data until the data is ready ('data ready' bit becomes low).

@ **Syntax**

Visual C++ (Win-95)
int W_9112_AD_Aquire (int card_number, int *ad_data)

Visual Basic (Win-95)
W_9112_AD_Aquire (ByVal card_number As Long, ad_data As Long)As Integer

C/C++ (DOS)

int _9112_AD_Aquire (int card_number, int *ad_data)

@ **Argument :**

card_number : the card number of PCI-9112
ad_data : 12-bit A/D converted value, the value should be within 0 to 4095.
Bit 0 ~ Bit 3 : is the converted channel number
Bit 4 ~ Bit 15 : is the converted A/D data.

@ **Return Code :**

ERR_NoError, ERR_BoardNoInit
ERR_AD_AquireTimeOut

@ **Example :**

```
#include "9112.h"
main()
{
    int    ad_data;
    int    errCode;
    Int    baseAddr, irqNo;

    _9112_Initial( CARD_1, &baseAddr, &irqNo);
    /* Assume NoError when Initialize PCI-9112 */

    /* Set to software trigger at first*/
    _9112_AD_Set_Mode(CARD_1, AD_MODE_0);
    /* then trigger the AD */
    _9112_AD_Soft_Trig(CARD_1);
```

```

/* wait for AD data ready then read it */
errCode = _9112_AD_Aquire(CARD_1, &ad_data);

if( errCode == ERR_NoError )
    printf( "The AD value is %d.\n", ad_data );
else
    printf( "AD conversion error happen\n" );
}

```

Also See Demo Program 'AD_DEMO1.C'

7.3.12 _9112_AD_DMA_Start

@ Description

The function will perform A/D conversion N times with DMA data transfer by using the pacer trigger (internal timer trigger). It takes place in the background which will not stop until the N-th conversion has completed or your program execute `_9112_AD_DMA_Stop()` function to stop the process.

After executing this function, it is necessary to check the status of the operation by using the function `_9112_AD_DMA_Status()`. The function is performed on single A/D channel when the A/D channel auto-scan is set as FALSE. If the A/D channel auto-scan is TRUE, the conversion will be multiple channels by sequence.

The PCI-9112 Bus mastering DMA is different from tradition PC style DMA. Its description is as following:

Bus Mastering DMA mode of PCI-9112:

PCI bus mastering offers the highest possible speed available on the PCI-9112. When the function ***_9112_AD_Set_Mode*** is set as `AD_MODE_2` (Timer Trigger & DMA transfer) or `AD_MODE_5` (External Trigger & DMA transfer), it will enable PCI bus master operation. This is conceptually similar to DMA (Direct Memory Access) transfers in a PC but is really PCI bus mastering. It does not use an 8237-style DMA controller in the host computer and therefore isn't blocked in 64K max. groups. PCI-9112 bus mastering works as follows:

1. To set up bus mastering, first do all normal PCI-9112 initialization necessary to control the board in status mode. This includes testing for the presence of the PCI BIOS, determining the base addresses, slot number, vendor and device ID's, I/O or memory, space allocation, etc. Please make sure your PCI-9112 is plug in a bus master slot, otherwise this function will not be workable.
2. Load the PCI controller with the count and 32-bit physical address of the start of previously allocated destination memory which will accept A/D data. This count is the number of *bytes* (not longwords!) transferred during the bus master operation and can be a large number up to 64 million (2^{26}) bytes. Since the PCI-9112 transfers are always longwords, this is 16 million longwords (2^{24}) or 32 million A/D samples but use the *bytecount*.
3. After the A/D conversion is started, the A/D converted data is stored in the FIFO of PCI controller. Each bus mastering data transfer continually tests if any data in the FIFO and then blocks transfer, the system will continuously loop until the conditions are satisfied again *but will not exit the block transfer cycle if the block count is not complete*. If there is momentarily no A/D data, the PCI-9112 will relinquish the bus temporarily but returns immediately when more A/D samples appear. This operation continues until the whole block is done.
4. This operation proceeds transparently until the PCI controller transfer byte count is complete. All normal PCI bus operation applies here such as a receiver which cannot accept the transfers, higher priority devices requesting the PCI bus, etc. Remember that only one PCI initiator can have bus mastership at any one time. However, review the PCI priority and "fairness" rules. Also study the effects of the Latency Timer. And be aware that the PCI priority strategy (round robin rotated, fixed priority, custom, etc.) is unique to your host PC and is explicitly *not* defined by the PCI standard. You must determine this priority scheme for your own PC (or replace it).
5. The interrupt request from the PCI controller can be optionally set up to indicate that this longword count is complete although this can also be determined by polling the PCI controller.

@ Syntax

Visual C++ (Win-95)

```
int W_9112_AD_DMA_Start (int card_number, int auto_scan, int
ad_ch_no, int ad_range, int count, HANDLE memID, int c1, int c2)
```

Visual Basic (Win-95)

```
W_9112_AD_DMA_Start (ByVal card_number As Long, ByVal
auto_scan As Long, ByVal ad_ch_no As Long, ByVal ad_range As
Long, ByVal count As Long, ByVal memID As Long, ByVal c1 As Long,
ByVal c2 As Long) As Long
```

C/C++ (DOS)

```
int _9112_AD_DMA_Start (int card_number, int auto_scan, int
ad_ch_no, int ad_range, int count , unsigned long *ad_buffer, int c1,int
c2)
```

@ Argument :

card_number : the card number of PCI-9112

auto_scan : TRUE or FALSE

Example1: auto_scan is FALSE, ad_ch_no is 3. Using DMA mode to read A/D data only channel 3.

Example2 : auto_scan is TRUE, ad_ch_no is 3. Using DMA mode to read A/D data with multi-channel , channel 3, 2, 1 and 0. Reading sequence is channel 3,2,1,0, 3,2,1,0,3,2,1,0....

ad_ch_no : A/D channel number

ad_range : A/D analog input range, the possible values are shown in section 4.3.8.

count : the number of A/D conversion

ad_buffer(DOS) : the start address of the memory buffer to store the AD data, the buffer size must large than the number of AD conversion.

In DOS environment, please make sure this memory is double-word alignment. Every 16-bit unsigned integer data in ad_buffer:

D11 D10 D9D1 D0 C3 C2 C1 C0

D11, D10, ..., D1, D0 : A/D converted data

C3, C2, C1, C0 : converted channel no.

memID(Win-95): the memory ID of the allocated system DMA memory. In Windows 95 environment, before calling **w_9112_AD_DMA_Start**, **w_9112_Alloc_DMA_Mem** must be called to allocate a contiguous DMA memory. **w_9112_Alloc_DMA_Mem** will return a memory ID for identify the allocated DMA memory, as well as the linear address of the DMA memory for user to access the data. The format of the A/D data is the same as DOS buffer (*ad_buffer* argument).

c1 : the 16-bit timer frequency divider of timer channel #1

c2 : the 16-bit timer frequency divider of timer channel #2

@ Return Code :

ERR_NoError, ERR_BoardNoInit, ERR_InvalidADChannel,
ERR_AD_InvalidRange, ERR_InvalidTimerValue

@ Example :

See Demo Program 'AD_DEMO3.C' , 'AD_DEMO6.C'

7.3.13 _9112_AD_DMA_Status

@ Description

Since the **_9112_AD_DMA_Start** function executes in background, you can issue the function **_9112_AD_DMA_Status** to check its operation status.

@ Syntax

Visual C++ (Win-95)
int **W_9112_AD_DMA_Status** (int card_number, int *status, int * count)

Visual Basic (Win-95)
W_9112_AD_Status (ByVal card_number As Long, status As Long,
count As Long) As Long

C/C++ (DOS)

```
int _9112_AD_DMA_Status(int card_number, int *status , int *count )
```

@ Argument :

card_number : the card number of PCI-9112

status : status of the DMA data transfer

0: AD_DMA_STOP : DMA is completed

1: AD_DMA_RUN : DMA is not completed

count : the number of A/D data which has been transferred.

@ Return Code :

ERR_NoError, ERR_BoardNoInit

@ Example :

See Demo Program 'AD_DEMO3.C' , 'AD_DEMO6.C'

7.3.14 _9112_AD_DMA_Stop**@ Description**

This function is used to stop the DMA data transferring. After executing this function, the internal A/D trigger is disable and the A/D timer (timer #1 and #2) is stopped. The function returns the number of the data which has been transferred, no matter if the A/D DMA data transfer is stopped by this function or by the DMA terminal count ISR.

@ Syntax

Visual C++ (Win-95)

```
int W_9112_AD_DMA_Stop (int card_number, int * count)
```

Visual Basic (Win-95)

```
W_9112_AD_DMA_Stop (ByVal card_number As Long, count As Long)  
As Long
```

C/C++ (DOS)

```
int _9112_AD_DMA_Stop (int card_number, int *count )
```

@ Argument :

card_number : the card number of PCI-9112

count : the number of A/D converted data which has been transferred.

@ Return Code :

ERR_NoError
ERR_BoardNoInit

@ Example :

See Demo Program 'AD_DEMO3.C', 'AD_DEMO6.C'

7.3.15 _9112_ContDmaStart

@ Description

The function will perform A/D conversion continuous with DMA data transfer by using the pacer trigger (internal timer trigger). It will takes place in the background which will not be stop until your program execute _9112_ContDmaStop() function to stop the process.

After executing this function, it is necessary to check the status of double buffer by using the function _9112_CheckHalfReady() and using _9112_DblBufferTransfer() to get the A/D converted data.

There is a group function for continuous A/D conversion using DMA as following:

```
_9112_ContDmaStart();  
_9112_CheckHalfReady();  
_9112_DblBufferTransfer();  
_9112_GetOverrunStatus();  
_9112_ContDmaStop();
```

@ Syntax

Visual C++ (Win-95)

```
int W_9112_ContDmaStart (int card_number, int auto_scan, int  
ad_ch_no, int ad_range, int count, HANDLE memID, int c1, int c2)
```

Visual Basic (Win-95)

```
W_9112_ContDmaStart (ByVal card_number As Long, ByVal  
auto_scan As Long, ByVal ad_ch_no As Long, ByVal ad_range As  
Long, ByVal count As Long, ByVal memID As Long, ByVal c1 As  
Long ByVal c2 As Long) As Long
```

C/C++ (DOS)

```
int _9112_ContDmaStart (int card_number, int auto_scan, int  
ad_ch_no, int ad_range, int count , int *db_buffer, int c1, int c2)
```

@ Argument :

card_number : the card number of PCI-9112

auto_scan : TRUE or FALSE

Example1 : auto_scan is FALSE, ad_ch_no is 3. Using DMA mode to read A/D data only channel 3.

Example2 : auto_scan is TRUE, ad_ch_no is 3. Using DMA mode to read A/D data with multi-channel, channel 3, 2, 1 and 0. Reading sequence is channel 3,2,1,0,3,2,1,0,3,2,1,0....

ad_ch_no : A/D channel number

ad_range : A/D analog input range, please refer to the section 4.3.8 for the possible values.

count : the number of A/D conversion

db_buffer(DOS) : the start address of the circular buffer to store the AD data, the buffer size must large than the number of AD conversion.

In DOS environment, please make sure this memory is double-word alignment. Every 16-bit unsigned integer data in ad_buffer:

D11 D10 D9D1 D0 C3 C2 C1 C0

D11, D10, ..., D1, D0 : A/D converted data

C3, C2, C1, C0 : converted channel no.

memID(Win-95) : the memory ID of the allocated system DMA memory to act as the circular buffer. In Windows 95 environment, before calling **W_9112_ContDmaStart**, **W_9112_Alloc_DMA_Mem** must be called to allocate a contiguous DMA memory. **W_9112_Alloc_DMA_Mem** will return a memory ID for identify the allocated DMA memory, as well as the linear address of the DMA memory for user to access the data. The format of the A/D data is the same as DOS buffer (*ad_buffer* argument).

c1 : the 16-bit timer frequency divider of timer channel #1
c2 : the 16-bit timer frequency divider of timer channel #2

@ Return Code :

ERR_NoError, ERR_BoardNoInit,
ERR_InvalidADChannel, ERR_AD_InvalidRange,
ERR_InvalidTimerValue

@ Example :

See Demo Program 'AD_DEMO7.C'

7.3.16 _9112_CheckHalfReady

@ Description

When you use _9112_ContDmaStart() to convert A/D data then you must use _9112_CheckHalfReady() to check data ready or not in the circular buffer, size of data is half of the circular buffer (count/2) and using _9112_DblBufferTransfer() to get data.

@ Syntax

Visual C++ (Win-95)
int W_9112_CheckHalfReady (int card_number, int * halfReady)

Visual Basic (Win-95)
int W_9112_CheckHalfReady (ByVal card_number As Long,
halfReady As Long) As Long

C/C++ (DOS)

int _9112_CheckHalfReady(int card_number, int *halfReady)

@ Argument :

card_number : the card number of PCI-9112
halfReady : TRUE or FALSE.

@ Return Code :

ERR_NoError, ERR_BoardNoInit

@ Example :

See Demo Program 'AD_DEMO7.C'

7.3.17 `_9112_DblBufferTransfer`

@ Description

Using this function to move the converted A/D data to user buffer.

@ Syntax

Visual C++ (Win-95)

```
int W_9112_DblBufferTransfer (int card_number, unsigned long far *  
userBuffer)
```

Visual Basic (Win-95)

```
W_9112_DblBufferTransfer (ByVal card_number As Long, userBuffer  
As Long) As Long
```

C/C++ (DOS)

```
int _9112_DblBufferTransfer(int card_number, unsigned long  
*userBuffer)
```

@ Argument :

card_number : the card number of PCI-9112

userBuffer : user buffer for A/D converted data, size of user buffer
is half of doubleBuf (count /2).

@ Return Code :

ERR_NoError, ERR_BoardNoInit

@ Example :

See Demo Program 'AD_DEMO7.C'

7.3.18 `_9112_GetOverrunStatus`

@ Description

When you use `_9112_ContDmaStart()` to convert A/D data and if you do not use `_9112_DblBufferTransfer` to move converted data then the double buffer overrun will occur, using this function to check overrun count.

@ Syntax

Visual C++ (Win-95)

```
int W_9112_GetOverrunStatus (int card_number, int * overrunCount)
```

Visual Basic (Win-95)

W_9112_GetOverrunStatus(ByVal card_number As Long, overrunCount As Long) As Long

C/C++ (DOS)

int _9112_GetOverrunStatus (int card_number, int *overrunCount)

@ Argument :

card_number : the card number of PCI-9112

overrunCount: number of overrun counts.

@ Return Code :

ERR_NoError, ERR_BoardNoInit

@ Example:

See Demo Program 'AD_DEMO7.C'

7.3.19 _9112_ContDmaStop

@ Description

This function is used to stop the continuous DMA data transferring.

@ Syntax

Visual C++ (Win-95)

int W_9112_ContDmaStop (int card_number)

Visual Basic (Win-95)

W_9112_ContDmaStop (ByVal card_number As Long) As Long

C/C++ (DOS)

int _9112_ContDmaStop (int card_number)

@ Argument :

card_number : the card number of PCI-9112

@ Return Code :

ERR_NoError, ERR_BoardNoInit

@ Example :

See Demo Program 'AD_DEMO7.C'

7.3.20 _9112_AD_INT_Start

@ Description

The function will perform A/D conversion N times with interrupt data transfer by using pacer trigger. It takes place in the background which will not stop until the N-th conversion has been completed or your program execute _9112_AD_INT_Stop() function to stop the process. After executing this function, it is necessary to check the status of the operation by using the function 9112_AD_INT_Status(). The function is performed on single A/D channel with fixed analog input range.

@ Syntax

Visual C++(Win-95)

```
int W_9112_AD_INT_Start(int card_number, int auto_scan, int
ad_ch_no, int ad_range, int count, unsigned long *ad_buffer,
int c1, int c2)
```

Visual Basic (Win-95)

```
W_9112_AD_INT_Start (ByVal card_number As Long, ByVal
auto_scan As Long, ByVal ad_ch_no As Long, ByVal ad_range As
Long, ByVal count As Long, ad_buffer As Integer,ByVal c1 As Long,
ByVal c2 As Long) As Long
```

C/C++ (DOS)

```
int _9112_INT_Start (int card_number, int auto_scan, int ad_ch_no, int
ad_range,int count, unsigned long *ad_buffer, int c1, int c2)
```

@ Argument :

card_number : the card number of PCI-9112

auto_scan : TRUE or FALSE

Example1 : auto_scan is FALSE, ad_ch_no is 3. Using DMA mode to read A/D data only channel 3.

Example2 : auto_scan is TRUE, ad_ch_no is 3. Using INT mode to read A/D data with multi-channel , channel 3, 2, 1 and 0. Reading sequence is channel 3,2,1,0, 3,2,1,0,3,2,1,0....

ad_ch_no : A/D channel number

ad_range : A/D analog input range, please refer to the section 4.3.8 for the possible values.

count : the number of A/D conversion
ad_buffer : the start address of the memory buffer to store the AD data, the buffer size must large than the number of AD conversion.

In DOS environment, please make sure this memory is double-word alignment. Every 16-bit unsigned integer data in ad_buffer:

D11 D10 D9D1 D0 C3 C2 C1 C0

D11, D10, ..., D1, D0 : A/D converted data
C3, C2, C1, C0 : converted channel no.

c1 : the 16-bit timer frequency divider of timer channel #1
c2 : the 16-bit timer frequency divider of timer channel #2

@ Return Code :

ERR_NoError, ERR_BoardNoInit
ERR_InvalidADChannel , ERR_AD_InvalidRange
ERR_InvalidTimerValue

@ Example :

See Demo Program 'AD_DEMO2.C' , 'AD_DEMO5.C'

7.3.21 _9112_AD_INT_Status

@ Description

Since the _9112_AD_INT_Start() function executes in background, you can issue the function _9112_AD_INT_Status to check the status of interrupt operation.

@ Syntax

Visual C++ (Win-95)
int W_9112_AD_INT_Status (int card_number, int *status, int * count)

Visual Basic (Win-95)
W_9112_INT_Status (ByVal card_number As Long, status As Long, count As Long) As Long

C/C++ (DOS)

```
int _9112_AD_INT_Status(int card_number, int *status , int *count )
```

@ Argument :

card_number : the card number of PCI-9112

status : status of the INT data transfer

0 : AD_INT_STOP : DMA is completed

1 : AD_INT_RUN : DMA is not completed

count : current conversion count number.

@ Return Code :

ERR_NoError, ERR_BoardNoInit

@ Example :

See Demo Program 'AD_DEMO2.C' , 'AD_DEMO5.C'

7.3.22 _9112_AD_INT_Stop

@ Description

This function is used to stop the interrupt data transfer function. After executing this function, the internal AD trigger is disable and the AD timer is stopped. The function returns the number of the data which has been transferred, no matter whether if the AD interrupt data transfer is stopped by this function or by the _9112_AD_INT_Stop() itself.

@ Syntax

Visual C++ (Win-95)

```
int W_9112_AD_INT_Stop(int card_number, int * count)
```

Visual Basic (Win-95)

```
W_9112_INT_Stop(ByVal card_number As Long, count As Long) As Long
```

C/C++ (DOS)

```
int _9112_AD_INT_Stop(int card_number, int *count )
```

@ Argument :

card_number : the card number of PCI-9112

count : the number of A/D data which has been transferred.

@ Return Code :

ERR_NoError

ERR_BoardNoInit

@ Example :

See Demo Program 'AD_DEMO2.C' , 'AD_DEMO5.C'

7.3.23 _9112_AD_Timer

@ Description

This function is used to setup the Timer #1 and Timer #2.

Timer #1 & #2 are used as frequency divider for generating constant A/D sampling rate dedicatedly. It is possible to stop the pacer trigger by setting any one of the dividers as 0. Because the AD conversion rate is limited due to the conversion time of the AD converter, the highest sampling rate of the PCI-9112 can not exceed 100 KHz. The multiplication of the dividers must be larger than 20.

@ Syntax

Visual C++ (Win-95)

int W_9112_AD_Timer (int card_number, unsigned int c1, unsigned int c2)

Visual Basic (Win-95)

W_9112_Timer (ByVal card_number As Long, c1 As Long, c2 As Long) As Long

C/C++ (DOS)

int _9112_AD_Timer(int card_number, unsigned int c1 , unsigned int c2)

@ Argument :

card_number : the card number of PCI-9112

c1 : frequency divider of timer #1

c2 : frequency divider of timer #2

Note : the A/D sampling rate is equal to :

$$2MHz / (c1 * c2),$$

when c1 = 0 or c2 = 0, the pacer trigger will be stopped.

@ Return Code :

ERR_NoError

```
ERR_BoardNoInit
ERR_InvalidTimerValue
```

@ Example :

```
main()
{
    int      errCode;
    Int      baseAddr, irqNo;
    _9112_Initial( CARD_1, &baseAddr, &irqNo);
    /* Assume NoError when Initialize PCI-9112 */

    _9112_AD_Timer(CARD_1,10 , 10 );
    /* set AD sampling rate to 2MHz/(10*10) */

    ..

    _9112_AD_Timer(CARD_1, 0 , 0);
    /* stop the pacer trigger */
}
```

7.3.24 _9112_TIMER_Start

@ Description

The Timer #0 on the PCI-9112 can be freely programmed by the users. This function is used to program the Timer #0. This timer can be used as frequency generator if internal clock is used. It also can be used as event counter if external clock is used. All the 8253 mode is available. Please refer to section5.4"Timer/Counter operation.

@ Syntax

Visual C++ (Win-95)

```
int W_9112_TIMER_Start (int card_number, int timer_mode, unsigned
int c0)
```

Visual Basic (Win-95)

```
W_9112_TIMER_Start(ByVal card_number As Long, timer_mode As
Long, c0 As Long) As Long
```

C/C++ (DOS)

```
int _9112_TIMER_Start(int card_number, int timer_mode, unsigned int
c0 )
```

@ Argument :

card_number : the card number of PCI-9112

timer_mode : the 8253 timer mode, the possible values are :

TIMER_MODE0, TIMER_MODE1,
TIMER_MODE2, TIMER_MODE3,
TIMER_MODE4, TIMER_MODE5.

c0 : the counter value of timer

@ Return Code :

ERR_NoError, ERR_BoardNoInit
ERR_InvalidTimerMode, ERR_InvalidTimerValue

7.3.25 _9112_TIMER_Read

@ Description

This function is used to read the counter value of the Timer #0.

@ Syntax

Visual C++ (Win-95)

int W_9112_TIMER_Read (int card_number, unsigned int far *
counter_value)

Visual Basic (Win-95)

W_9112_TIMER_Read (ByVal card_number As Long, counter_value
As Long) As Long

C/C++ (DOS)

int _9112_TIMER_Read (int card_number, unsigned int
*counter_value)

@ Argument :

card_number : the card number of PCI-9112

counter_value : the counter value of the Timer #0

@ Return Code :

ERR_NoError, ERR_BoardNoInit

7.3.26 _9112_TIMER_Stop

@ Description

This function is used to stop the timer operation. The timer is set to the 'One-shot' mode with counter value ' 0 '. That is, the clock output signal will be set to high after executing this function.

@ Syntax

Visual C++(Win-95)

```
int W_9112_TIMER_Stop (int card_number, unsigned int *  
counter_value)
```

Visual Basic (Win-95)

```
W_9112_TIMER_Stop (ByVal card_number As Long, counter_value  
As Long) As Long
```

C/C++ (DOS)

```
int _9112_TIMER_Stop (int card_number, unsigned int *counter_value )
```

@ Argument :

card_number : the card number of PCI-9112

counter_value : the current counter value of the Timer #0

@ Return Code :

ERR_NoError

ERR_BoardNoInit

7.3.27 _9112_Alloc_DMA_Mem

@ Description

Contact Windows 95 system to allocate a block of contiguous memory for DMA transfer. This function is only available in Windows 95 version.

@ Syntax

Visual C++(Win-95)

```
int W_9112_Alloc_DMA_Mem (unsigned long buf_size, HANDLE  
*memID, unsigned long *linearAddr)
```

Visual Basic (Win-95)

```
W_9112_Alloc_DMA_Mem (ByVal buf_size As Long, memID As Long,  
linearAddr As Long) As Long
```

@ Argument :

buf_size: Bytes to allocate. Please be careful, the unit of this argument is BYTE, not SAMPLE.

memID: If the memory allocation is successful, driver returns the ID of that memory in this argument. Use this memory ID in **W_9112_AD_DMA_Start** or **W_9112_ContDmaStart** function call.

linearAddr: The linear address of the allocated DMA memory. You can use this linear address as a pointer in C/C++ to access the DMA data.

@ Return Code :

ERR_NoError
ERR_AllocDMAMemFailed

7.3.28 `_9112_Free_DMA_Mem`

@ Description

Deallocate a system DMA memory under Windows 95 environment. This function is only available in Windows 95 version.

@ Syntax

Visual C++(Win-95)
int `W_9112_Free_DMA_Mem` (HANDLE memID)

Visual Basic (Win-95)
`W_9112_Free_DMA_Mem` (ByVal memID As Long) As Long

@ Argument :

memID: The memory ID of the system DMA memory to deallocate.

@ Return Code :

ERR_NoError

7.3.29 `_9112_Get_Sample`

@ Description

For the language without pointer support such as Visual Basic, programmer can use this function to access the index-th data in DMA buffer. This function is only available in Windows 95 version.

@ Syntax

Visual C++(Win-95)
int `W_9112_Get_Sample` (unsigned long linearAddr, unsigned index, unsigned short *ai_data)

Visual Basic (Win-95)
`W_9112_Get_Sample` (ByVal linearAddr As Long, ByVal idx As Long, ai_data As Integer) As Long

@ Argument :

linearAddr: The linear address of the allocated DMA memory.

index: The index of the sample to retrieve. The first sample is with index 0.

ai_data: Returns the sample retrieved.

@ Return Code :

ERR_NoError

Appendix A. Demo. Programs

DOS Environment :

In this software CD, there are 8 DOS demonstration programs are provided. They could help you to program your application by using C Language Library easily. The description of these programs are specified as follows:

AD_DEMO1.C :	A/D conversion uses software trigger and program data transfer.
AD_DEMO2.C	A/D conversion uses interrupt and program data transfer.
AD_DEMO3.C :	A/D conversion uses DMA data transfer.
AD_DEMO4.C :	A/D conversion uses software trigger and program data transfer. (autoscan enable, multi-channel)
AD_DEMO5.C	A/D conversion uses interrupt and program data transfer. autoscan enable, multi-channel)
AD_DEMO6.C :	A/D conversion uses DMA data transfer. autoscan enable, multi-channel)
AD_DEMO7.C :	Continue A/D converted by DMA transfer
DA_DEMO.C :	D/A conversion
DIO_DEMO.C :	Read/Write data from digital input/output channels

Window 3.11, Win-95 amd Win-NT Environments :

There are 3 demonstration programs for each of Windows environemnts in Software CD. They could help you to program your application by using C/C++ Language to link with DLL library in different O.S. platforms. You can learn how to program and link with DLL library of PCI-9112.

The description of these programs are specified as follows:

9112DMA.EXE	A/D conversion uses software trigger and program data transfer.
9112INT.EXE	A/D conversion uses interrupt and program data transfer.
9112UTIL.EXE	A/D conversion uses DMA data transfer.

Product Warranty/Service

Seller warrants that equipment furnished will be free from defects in material and workmanship for a period of one year from the confirmed date of purchase of the original buyer and that upon written notice of any such defect, Seller will, at its option, repair or replace the defective item under the terms of this warranty, subject to the provisions and specific exclusions listed herein.

This warranty shall not apply to equipment that has been previously repaired or altered outside our plant in any way as to, in the judgment of the manufacturer, affect its reliability. Nor will it apply if the equipment has been used in a manner exceeding its specifications or if the serial number has been removed.

Seller does not assume any liability for consequential damages as a result from our products uses, and in any event our liability shall not exceed the original selling price of the equipment.

The equipment warranty shall constitute the sole and exclusive remedy of any Buyer of Seller equipment and the sole and exclusive liability of the Seller, its successors or assigns, in connection with equipment purchased and in lieu of all other warranties expressed implied or statutory, including, but not limited to, any implied warranty of merchant ability or fitness and all other obligations or liabilities of seller, its successors or assigns.

The equipment must be returned postage-prepaid. Package it securely and insure it. You will be charged for parts and labor if you lack proof of date of purchase, or if the warranty period is expired.