

# SOLDER PRACTICE KIT

MODEL SP-3B



Assembly and Instruction Manual

**Elenco® Electronics, Inc.**

# PARTS LIST

If you are a student, and any parts are missing or damaged, please see instructor or bookstore.

If you purchased this kit from a distributor, catalog, etc., please contact Elenco® Electronics (address/phone/e-mail is at the back of this manual) for additional assistance, if needed. **DO NOT** contact your place of purchase as they will not be able to help you.

## RESISTORS

**Note:** Please refer to page 7 for the resistor reading exercise. This will familiarize you with the resistor color band coding.

Qty.	Symbol	Value	Color Code	Part #
□ 2	R1, R7	100Ω 5% 1/4W	brown-black-brown-gold	131000
□ 2	R2, R8	150Ω 5% 1/4W	brown-green-brown-gold	131500
□ 2	R3, R9	200Ω 5% 1/4W	red-black-brown-gold	132000
□ 2	R4, R10	220Ω 5% 1/4W	red-red-brown-gold	132200
□ 2	R5, R11	330Ω 5% 1/4W	orange-orange-brown-gold	133300
□ 1	R13	18kΩ 5% 1/4W	brown-gray-orange-gold	151800
□ 1	R14	27kΩ 5% 1/4W	red-violet-orange-gold	152700
□ 1	R15	39kΩ 5% 1/4W	orange-white-orange-gold	153900
□ 1	R16	47kΩ 5% 1/4W	yellow-violet-orange-gold	154700
□ 2	R6, R12	56kΩ 5% 1/4W	green-blue-orange-gold	155600
□ 1	R17	100kΩ 5% 1/4W	brown-black-yellow-gold	161000
□ 1	R18	120kΩ 5% 1/4W	brown-red-yellow-gold	161200
□ 1	R19	470kΩ 5% 1/4W	yellow-violet-yellow-gold	164700
□ 1	R20	680kΩ 5% 1/4W	blue-gray-yellow-gold	166800

## CAPACITORS

Qty.	Symbol	Value	Description	Part #
□ 2	C1, C2	10μF 16V	Electrolytic	271015

## SEMICONDUCTORS

Qty.	Symbol	Value	Description	Part #
□ 2	Q1, Q2	2N3904	Transistor NPN	323904
□ 2	LED1, LED2	Red	LED (Light Emitting Diode)	350002

## MISCELLANEOUS

Qty.	Symbol	Description	Part #
□ 1		PC Board	517042
□ 1	SW1	Slide Switch	541102
□ 1	U1	16-pin IC Socket	664016
□ 1		Desoldering Wick	556000
□ 1		Battery Snap	590098
□ 36"		Wire 22AWG Topcoat	814600
□ 1		Color Code Calculator	9CC100
□ 1		Solder Tube	9ST4

## PARTS IDENTIFICATION

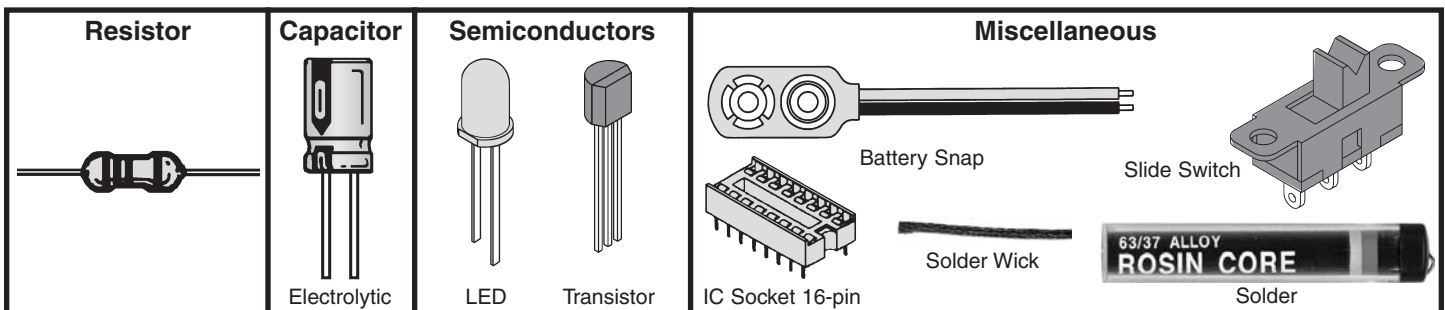

## IDENTIFYING RESISTOR VALUES

Use the following information as a guide in properly identifying the value of resistors.

BAND 1 1st Digit		BAND 2 2nd Digit		Multiplier		Resistance Tolerance	
Color	Digit	Color	Digit	Color	Multiplier	Color	Tolerance
Black	0	Black	0	Black	1	Silver	$\pm 10\%$
Brown	1	Brown	1	Brown	10	Gold	$\pm 5\%$
Red	2	Red	2	Red	100	Brown	$\pm 1\%$
Orange	3	Orange	3	Orange	1,000	Red	$\pm 2\%$
Yellow	4	Yellow	4	Yellow	10,000	Orange	$\pm 3\%$
Green	5	Green	5	Green	100,000	Green	$\pm 0.5\%$
Blue	6	Blue	6	Blue	1,000,000	Blue	$\pm 0.25\%$
Violet	7	Violet	7	Silver	0.01	Violet	$\pm 0.1\%$
Gray	8	Gray	8	Gold	0.1		
White	9	White	9				

### BANDS

**Note:** Please refer to the Resistor Reading Exercise on page 7 before starting assembly of your solder practice kit.

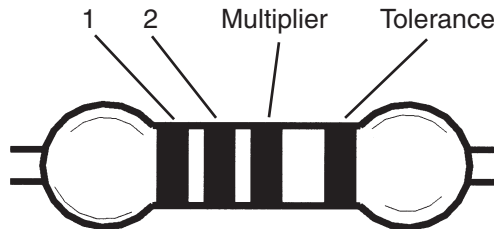

## IDENTIFYING CAPACITOR VALUES

Capacitors will be identified by their capacitance value in pF (picofarads), nF (nanofarads), or  $\mu\text{F}$  (microfarads). Most capacitors will have their actual value printed on them. Some capacitors may have their value printed in the following manner. The maximum operating voltage may also be printed on the capacitor.

Multiplier	For the No.	0	1	2	3	4	5	8	9
		Multiply By	1	10	100	1k	10k	100k	0.01

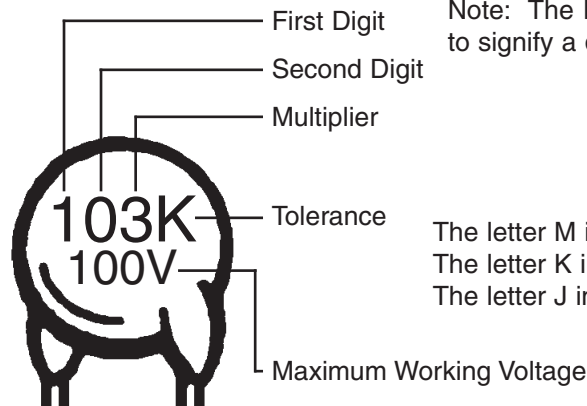

Note: The letter "R" may be used at times to signify a decimal point; as in 3R3 = 3.3

The letter M indicates a tolerance of  $\pm 20\%$   
 The letter K indicates a tolerance of  $\pm 10\%$   
 The letter J indicates a tolerance of  $\pm 5\%$

The value is  $10 \times 1,000 = 10,000\text{pF}$  or  $.01\mu\text{F}$  100V

## METRIC UNITS AND CONVERSIONS

Abbreviation	Means	Multiply Unit By	Or
p	Pico	.000000000001	$10^{-12}$
n	nano	.000000001	$10^{-9}$
$\mu$	micro	.000001	$10^{-6}$
m	milli	.001	$10^{-3}$
-	unit	1	$10^0$
k	kilo	1,000	$10^3$
M	mega	1,000,000	$10^6$

- 1,000 pico units = 1 nano unit
- 1,000 nano units = 1 micro unit
- 1,000 micro units = 1 milli unit
- 1,000 milli units = 1 unit
- 1,000 units = 1 kilo unit
- 1,000 kilo units = 1 mega unit

## INTRODUCTION

Almost every electronic device today has a printed circuit board. Whether you are assembling a PC board or repairing it, you must understand the basics of working with these boards.

Good soldering requires practice and an understanding of soldering principles. This solder practice project will help you achieve good soldering techniques, help you to become familiar with a variety of electronic components, and provide you with dynamic results. If the circuit is assembled and soldered properly, two LEDs will alternately flash.

### Safety Precautions

Like all electrical devices, the solder station must be handled with care. The soldering iron and tip can reach high temperatures and these simple safety rules should be followed.

- Keep children out of reach of the soldering station.
- To protect your eyes, use safety goggles.
- Keep flammable material away from the soldering iron.
- **DO NOT cool iron** by dipping it into any liquid or water.
- Always assume that the tip is hot to avoid burns.
- Work in an area that is well ventilated.
- Be careful that the hot soldering iron tip or the barrel of the iron does not come in contact with any electrical cord.
- **Do not hold solder in your mouth.** Solder contains lead and is a toxic substance. Wash your hands thoroughly after handling solder.
- Locate soldering iron in an area where you do not have to go around it or reach over it.

### Solder

Solder is a fusible alloy composed of tin and lead. Some solder may contain small amounts of other material for use in special purposes to enhance its characteristics. Solder has a melting temperature around 360° to 370°, making it ideal for forming a metallic joint between two metals.

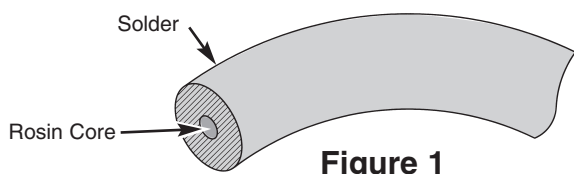

Figure 1

Solder is identified by the ratio of tin-to-lead. The most common ratios are 63/37, 60/40, and 50/50. The first number indicates the amount of tin and the second is lead. A 63/37 solder has 63% tin and 37% lead. Solder with a greater tin content melts at a lower temperature, takes less time to harden, and generally makes it easier to do a good soldering job. The ratio of tin is a main factor in the strength of the solder joint. Solder with a greater tin content has a greater holding ability under stress. Solder with a tin ratio of 63% is the strongest, while solder with less than 30% would be undesirable.

### Flux

Most solder contains flux in the hollow core of the solder allowing it to be applied automatically when you heat the solder. The flux will remove any oxide film on the metals soldered creating a good metal-to-metal contact. This is called "wetting the metal". There are three types of solder fluxes: chloride, organic and rosin. In the electronics industry, only the rosin type is used. Rosin flux comes in two types, pure and active. The most reliable is the pure type, since it doesn't cause dendrites between tracks on the PC board as the active type does. Due to the highly corrosive and moisture attracting characteristics of the chloride and organic type fluxes, they should not be used in electronics.

### Surface Preparation

In order for the solder to adhere to the connection, the metals must be clean and free of nonmetallic materials. Flux in the solder can remove oxides from metal but not other materials like dirt or grease. To remove these, use a small steel brush or fine emery cloth.

### Mechanical Connection

When all the surfaces are clean, the metals should have a solid mechanical connection. Wires should be tightly wrapped around each other or to the terminal. This will eliminate large gaps that create weak solder joints. Solder should not be used as a mechanical connection.

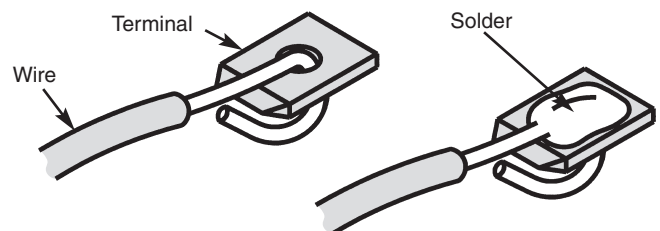

Figure 2

## Types of Soldering Devices

A number of different types of soldering devices: irons, guns and stations are available today. Irons are used for light to medium work and guns are for medium to heavy-duty work. The station type can range from light to heavy-duty. For working on PC boards, irons ranging from 15 to 40 watts are suitable, or a station with a range of 15 to 40 watts. If you use an iron with a higher wattage rating than 40 watt, you may damage the copper tracks on the PC board. The higher wattage irons are best suited for heavy-duty electrical jobs.



## Solder Tips

The tip is the very important part of the iron. The material that the tip is made from is an essential factor. The soldering iron tip contains four different metals as shown in Figure 3. The core consists of copper. Since the copper is a soft material, it is plated with iron. Chrome plating is used on the area where no soldering takes place to prevent oxidation. Then the tip is plated with tin, because it can be easily cleaned.

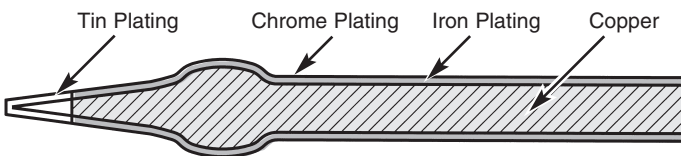
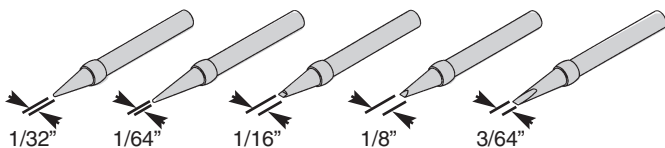

Figure 3

Today, tips are manufactured in a variety of different shapes (see figure below). The chisel shape is one of the most common. Having a choice of tip styles allows you to choose the one best suited for your soldering needs. Due to the high heat, removable tips can bond themselves to the heating element if left in place for extended periods of time. Periodic removal of the tip is therefore advisable.



## Tip Cleaning

A good clean solder tip makes soldering much easier. The tip should be tinned by lightly coating it with solder to prevent it from oxidizing. The tip can become pitted (black spots) from normal use. It is important to clean the tip by wiping it with a wet sponge or rag. For tips that need a good cleaning, the tip tinner and cleaner (#TTC1) should be used. **Never use a file or abrasive material to clean the tip.** Using such methods will damage the plating and ruin the tip. Do not remove the excess solder from the tip before storing. The excess solder will prevent oxidation.

## Clean Connections

Proper solder adhesion requires that the metal surface to be free of dirt and grease. The flux only removes the oxides so a brush or rag can be used to clean metal. There are contact cleaners in aerosol cans and other solvents available.

## Desoldering

Great care should be taken when repairing or correcting a mistake on a PC board. The metal foil can be easily pulled up or broken from excessive heat. Use the least amount of heat as possible. You can use a desoldering tool, bulb, wick or a station. These tools will remove the solder enabling you to correct the problem.



Solder Wick



Desoldering Station



# SOLDER PRACTICE

## Double Pads

Before we begin to assemble and solder the components to the solder practice PC board, we will start first by practice soldering to the double pads on the edge of the PC board (see Figure 4).



Figure 4

1. Apply a small amount of solder to the iron tip. This allows the heat to leave the iron and onto the foil.
2. Place the iron on the top half of pad and then apply the solder (see Figure 5). Allow the solder to flow around the pad. Then, remove the solder and the iron and let the solder cool. The solder should be neat and smooth.
3. Repeat step 2 on the bottom half of the pad (see Fig. 5).
4. Practice again on the second large pad.

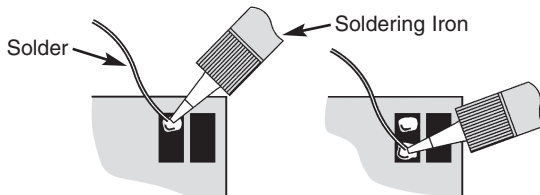
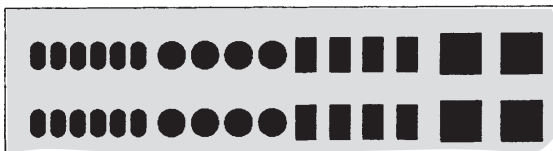

Figure 5

## Single Pads

Now practice using the single pads. Start with the four square pads and use the same soldering procedures as the large pads. Note that the spacing between the pads decrease as the pads get smaller. Be sure there are no solder bridges between the pads.



## Solder Bridge

Solder bridges occur when solder runs between circuit paths and creates a short circuit. This is usually caused by using too much solder. Try to intentionally make a solder bridge on each section (see Figure 6). Then, remove it by simply dragging your soldering iron across the solder bridge as shown. It is best to wipe the iron tip with a wet sponge to remove the solder. You can also use solder wick as described on page 7.

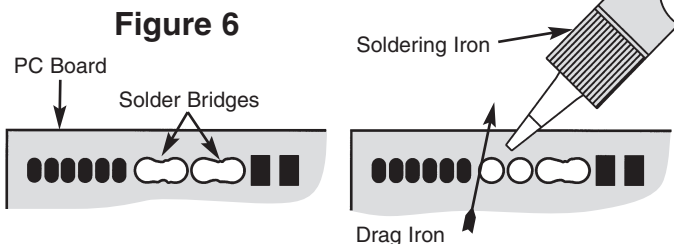

Figure 6

## Tack Soldering

You will make 10 tack solder connections by soldering five wires to the top row of pads.

1. Cut 5 one-inch wires and strip 1/8" insulation off both ends.
2. Place the iron and the wire on top left pad as shown in Figure 7. Allow the solder to flow around the wire. Then, remove the iron and let the solder cool. You may need to add some more solder. The solder should be neat and smooth.
3. Pull the wire to make sure you have a good solder joint.
4. Bend the wire and solder it to the next pad, as shown in Figure 7.
5. Now solder the remaining wires to the pads as shown in Figure 7.

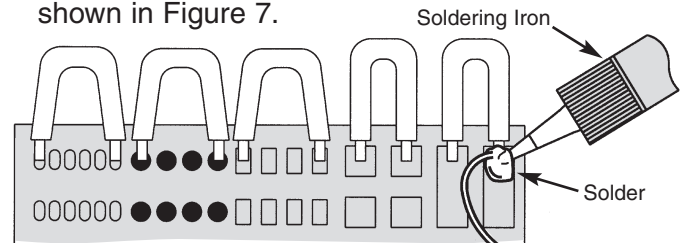

Figure 7

## Jumper Wires

In this section, you will solder 20 jumpers between the two rows of holes.

1. Cut a one-inch wire and strip 1/8" insulation off both ends.
2. Insert the wire between the top and bottom hole (see Figure 8a).
3. Apply a small amount of solder to the tip. Immediately apply solder to the opposite side of the connection, away from the iron. Allow the heated wire and circuit foil to melt the solder (see Figure 8b).
4. Cut off the excess leads.
5. Solder the remaining 19 jumper wires.

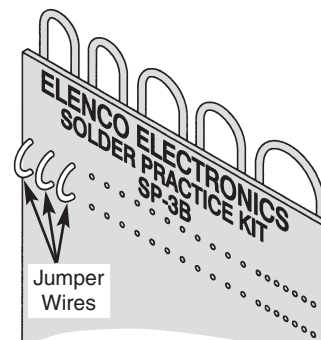

Figure 8a

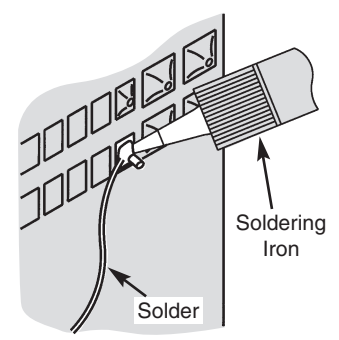

Figure 8b

## PC BOARD REPAIR

### Hairline Cracks

The hairline cracks can develop in the copper foil if the PC board is flexed. This can be easily repaired by making a solder bridge across the two foils. The solder should smoothly flow across the foil as shown in Figure 9. If the solder does not adhere to the foil, it will sit on the foil as a blob as shown in Figure 10.

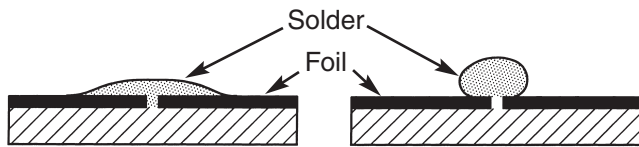

Figure 9

Figure 10

1. Make five solder bridges using the second row of single pads, starting from the left side (see Figure 11).

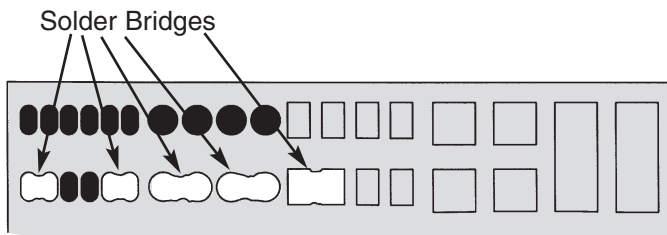

Figure 11

### Reinforcing a Repair

A solder bridge repair can be reinforced using a solid wire. Now add a wire to the five solder bridges you just made.

1. Strip a 1/2" of insulation off one end of the wire and then tin it.
2. Hold the tinned wire on top of the solder bridge.
3. Place the iron on the wire until the solder melts.
4. Remove the iron while holding the wire in place against the foil. Make sure the wire does not move until the solder hardens.
5. Check for a good solder connection.
6. Cut the wire off as close to the solder joint as possible.
7. Practice this procedure four more times.

### Wide Gaps

Wide gaps in the copper foil can be bridged using a small wire soldered across the gaps (see Figure 12). Four wires will be soldered across the two rows of small solder pads.

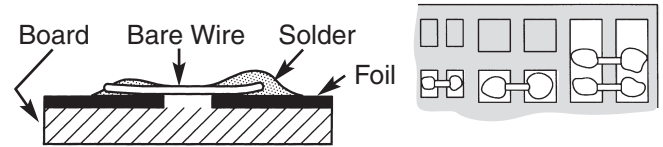

Figure 12

1. Place the iron on the top of a pad and then apply the solder (see Figure 12). Allow the solder to flow around and form a small pool.
2. Repeat Step 1 on the adjacent pad.
3. Strip 1/2" of insulation off one end of the wire and then tin it.
4. Position the wire on top of the solder pad and then place the iron on the wire. As the solder melts, the wire will be pressed down against the pad (see Figure 12). Remove the iron while holding the wire in place. Make sure the wire does not move until the solder hardens.
5. Check for a good solder connection.
6. Repeat step 4 on the adjacent pad.
7. Cut the wire off as close to the solder joint as possible (see Figure 12).
8. You can hold the wire down with a screwdriver and resolder if needed.
9. Practice this procedure three more times on the remaining pads.

## REMOVING EXCESS SOLDER USING DESOLDERING WICK

Desoldering wick is a braided wire coated with non-corrosive rosin flux. It is the simplest and safest tool for removing solder from a solder connection. When the braided wire is heated, the flux cleans and breaks up the surface tension so the melted solder from the connection flows into the braid by capillary action.

Included in this kit is a six inch length of solder wick (desoldering braid).

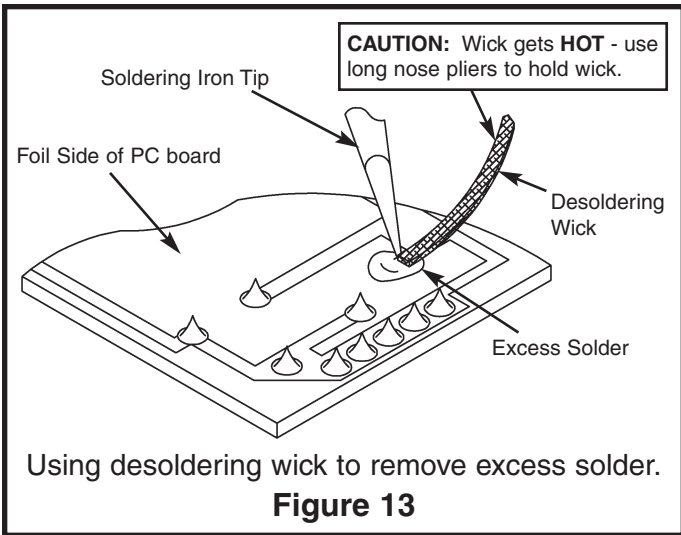

### Using the Desoldering Wick

1. Place the wick against the solder with the tip of a hot soldering iron (see Figure 13).
2. The molten solder is sucked up into the wick by capillary action.
3. When the iron and wick are removed, the solder should be removed. You need to repeat the process if some solder remains.

If necessary, repeat the procedure until all of the unwanted solder is removed.

After the excess solder has been removed, clip off and discard the solder-saturated portion of the braid. For best results, always use a fresh area of the braid for each procedure.

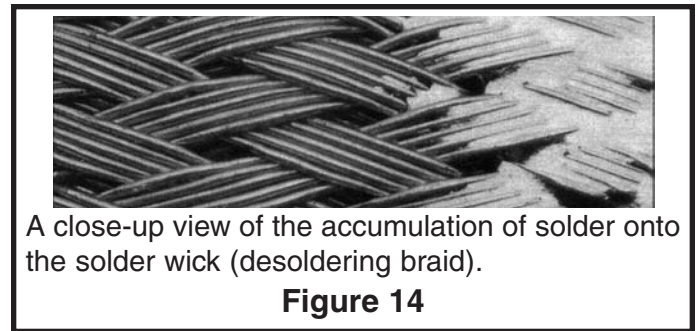

## RESISTOR READING EXERCISE

Before starting assembly of your solder practice project, you should be thoroughly familiar with the 4-band color code system. Many of the resistor values will be identified by color bands and it is easy to mistake their value if you read the colors incorrectly or read the value from the wrong end. Do the following exercise in resistor values. Place your answer in the box beneath the resistor. Answers are on the bottom of this page.

(1) brown-green-red-gold



(2) brown-black-orange-gold



(3) brown-black-yellow-gold



(4) red-red-orange-gold



(5) yellow-violet-brown-gold



(6) blue-gray-orange-gold

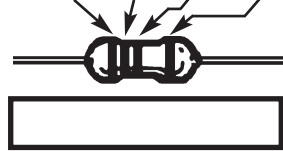

(7) yellow-violet-black-gold

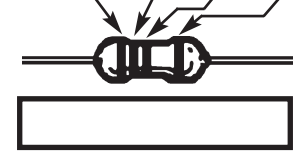

(8) brown-blue-brown-gold

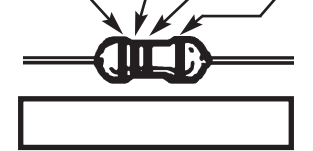

(9) orange-orange-red-gold



(10) green-brown-red-gold



(11) brown-black-green-gold

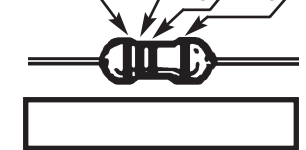

(12) brown-gray-orange-gold

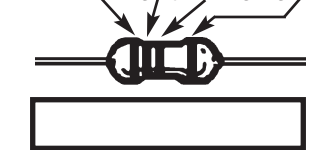

Answers to Resistor Reading Exercise: 1) 1.5kΩ±5%; 2) 10kΩ±5%; 3) 100kΩ±5%; 4) 22kΩ±5%; 5) 470Ω±5%; 6) 68kΩ±5%; 7) 47Ω±5%; 8) 160Ω±5%; 9) 3.3kΩ±5%; 10) 5.1kΩ±5%; 11) 11MΩ±5%; 12) 18kΩ±5%



# THEORY OF OPERATION

The solder practice kit consists of a circuit oscillating at one hertz (one cycle per second). The oscillator consists of two transistors Q1 and Q2, and resistors, R1 - R11 and capacitors C1 and C2. This configuration is known as a multivibrator circuit.

When voltage is first applied to this multivibrator circuit, one transistor (possibly Q1) will conduct faster, causing transistor Q2 to stay off. Q1 will continue to conduct until it saturates. At this point,

Q2 will start to conduct, causing Q1 to rapidly cutoff. This process continues alternately causing Q1 or Q2 to conduct. The output will be a square wave. The frequency is determined by the time constants of resistor R6 and capacitor C1, also R12 and C2. Two LED diodes are placed in the collectors of the transistors and will light when current is passing through them. Resistors R1 - R5, R7 -R11 determine the current passing through the LEDs.

# SCHEMATIC DIAGRAM

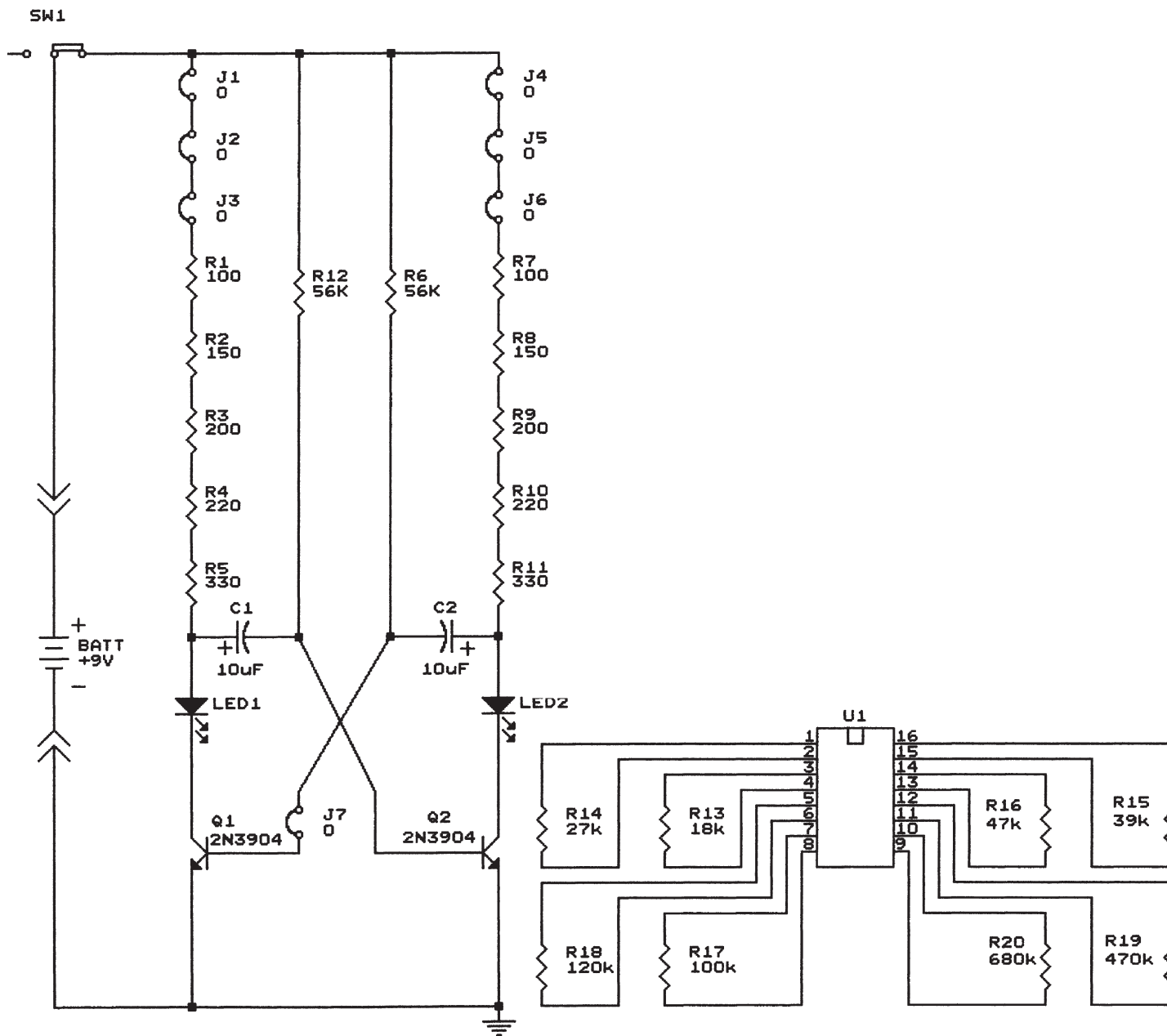

# SOLDERING COMPONENTS TO THE PC BOARD

A poorly soldered joint can greatly affect small current flow in circuits and can cause equipment failure. You can damage a PC board or a component with too much heat or cause a cold solder joint with insufficient heat. Sloppy soldering can cause bridges between two adjacent foils preventing the circuit from functioning.

## Safety Procedures

- Wear eye protection when soldering.
- Locate soldering iron in an area where you do not have to go around it or reach over it.
- **Do not hold solder in your mouth.** Solder contains lead and is a toxic substance. Wash your hands thoroughly after handling solder.
- Be sure that there is adequate ventilation present.

## What Good Soldering Looks Like

A good solder connection should be bright, shiny, smooth, and uniformly flowed over all surfaces.

## Soldering a PC board

1. Solder all components from the copper foil side only. Push the soldering iron tip against both the lead and the circuit board foil.

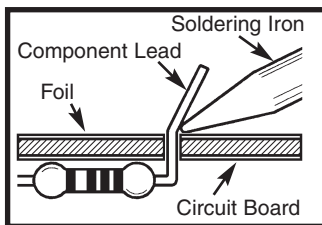

2. Apply a small amount of solder to the iron tip. This allows the heat to leave the iron and onto the foil. Immediately apply solder to the opposite side of the connection, away from the iron. Allow the heated component and the circuit foil to melt the solder.

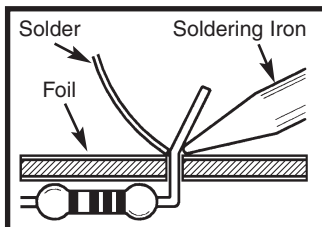

3. Allow the solder to flow around the connection. Then, remove the solder and the iron and let the connection cool. The solder should have flowed smoothly and not lump around the wire lead.

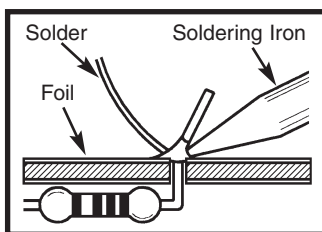

4. Here is what a good solder connection looks like.

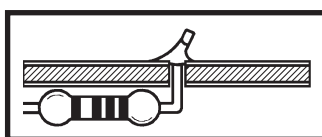

## Types of Poor Soldering Connections

1. **Insufficient heat** - the solder will not flow onto the lead as shown.

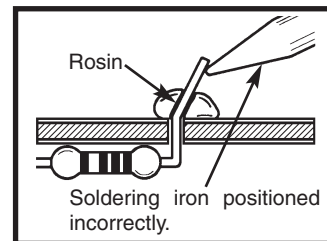

2. **Insufficient solder** - let the solder flow over the connection until it is covered. Use just enough solder to cover the connection.

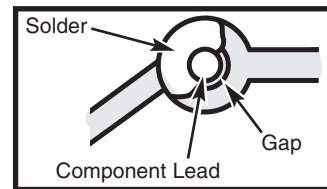

3. **Excessive solder** - could make connections that you did not intend to between adjacent foil areas or terminals.

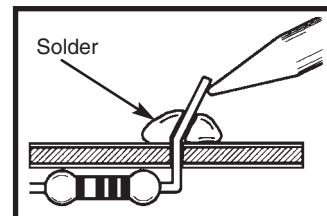

## Heat Sinking

Electronic components such as transistors, IC's, and diodes can be damaged by the heat during soldering. Heat sinking is a way of reducing the heat on the components while soldering. Dissipating the heat can be achieved by using long nose pliers, an alligator clip, or a special heat dissipating clip. The heat sink should be held on the component lead between the part and the solder joint.

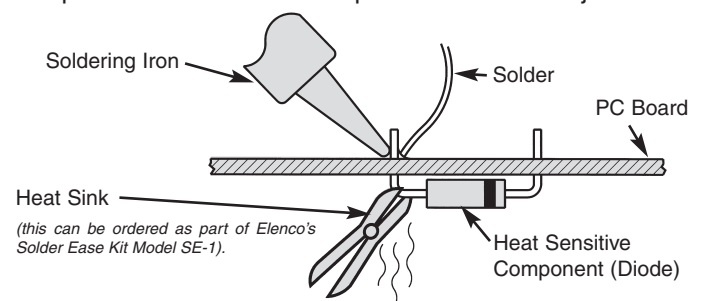

# PC BOARD ASSEMBLY

Solder the following parts to the PC board.

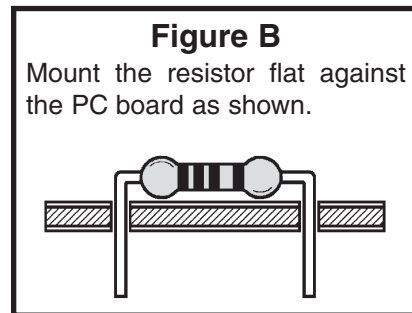
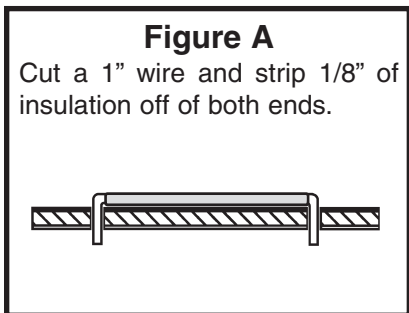
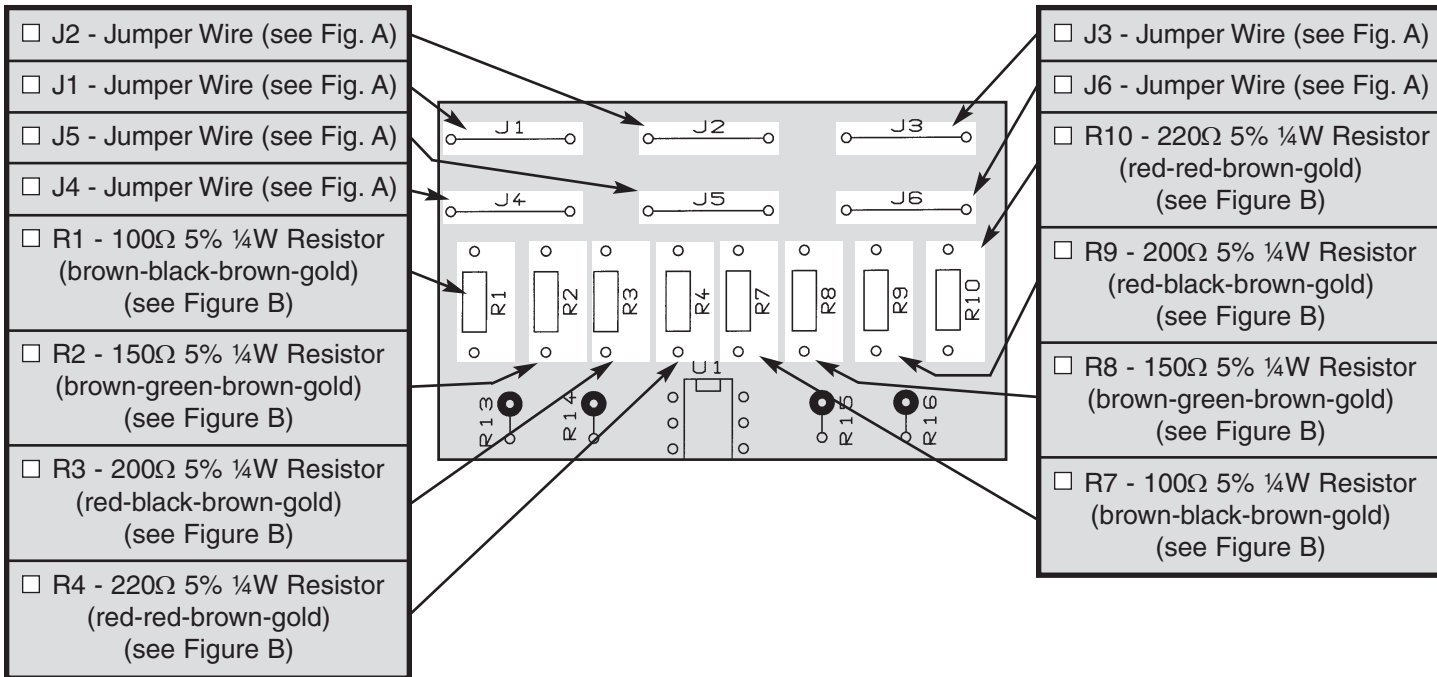

## Resistance Testing #1 (If you do not have a meter, continue to page 11)

You will test the solder connections by measuring the resistance from the following points. If your readings are different, double check your soldering connections.

Location	Value	Circuit
<input type="checkbox"/> Point A (left side of J1) to point B (right side of J3)	0.1 - 1Ω	(J1-J3)
<input type="checkbox"/> Point A (left side of J1) to point C (top lead of R4)	670Ω ±5%	(J1-J3, R1-R4)
<input type="checkbox"/> Point D (left side of J4) to point E (right side of J6)	0.1 - 1Ω ±5%	(J4-J6)
<input type="checkbox"/> Point D (left side of J4) to point F (top lead of R10)	670Ω ±5%	(J4-J6, R7-R10)

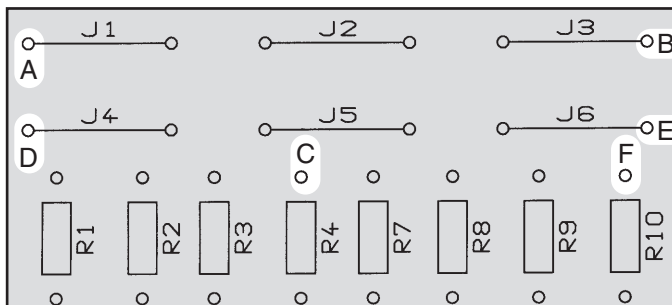

## PC BOARD ASSEMBLY (continued)

Solder the following parts to the PC board.

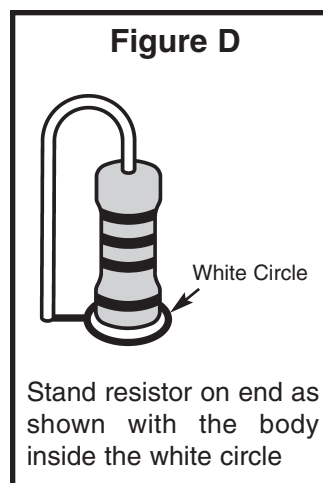
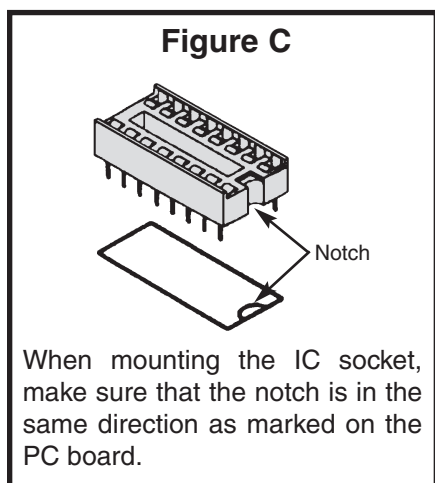
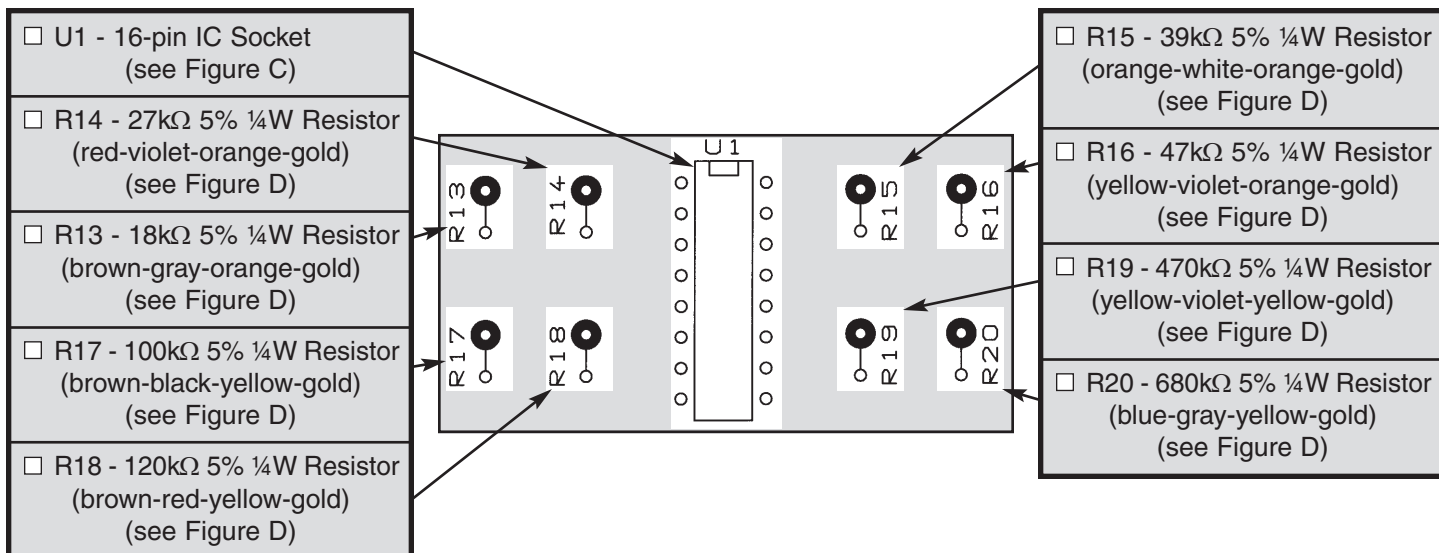

### Resistance Testing #2 (If you do not have a meter, continue to page 12)

Each resistor is connected across two pins of the IC socket. You will test the solder connections by measuring the resistance from the following IC pins. If your readings are different, double check your soldering connections.

Location	Value
<input type="checkbox"/> R14 - Measure from pin 1 to pin 2	27kΩ +/- 5%
<input type="checkbox"/> R13 - Measure from pin 3 to pin 4	18kΩ +/- 5%
<input type="checkbox"/> R17 - Measure from pin 5 to pin 6	120kΩ +/- 5%
<input type="checkbox"/> R18 - Measure from pin 7 to pin 8	100kΩ +/- 5%
<input type="checkbox"/> R19 - Measure from pin 9 to pin 10	470kΩ +/- 5%
<input type="checkbox"/> R20 - Measure from pin 11 to pin 12	680kΩ +/- 5%
<input type="checkbox"/> R16 - Measure from pin 13 to pin 14	47kΩ +/- 5%
<input type="checkbox"/> R15 - Measure from pin 15 to pin 16	39kΩ +/- 5%

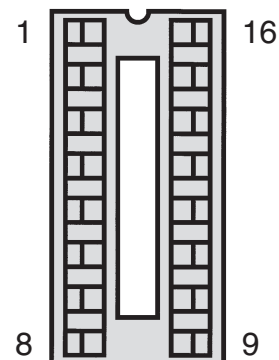

## PC BOARD ASSEMBLY (continued)

Solder the following parts to the PC board.

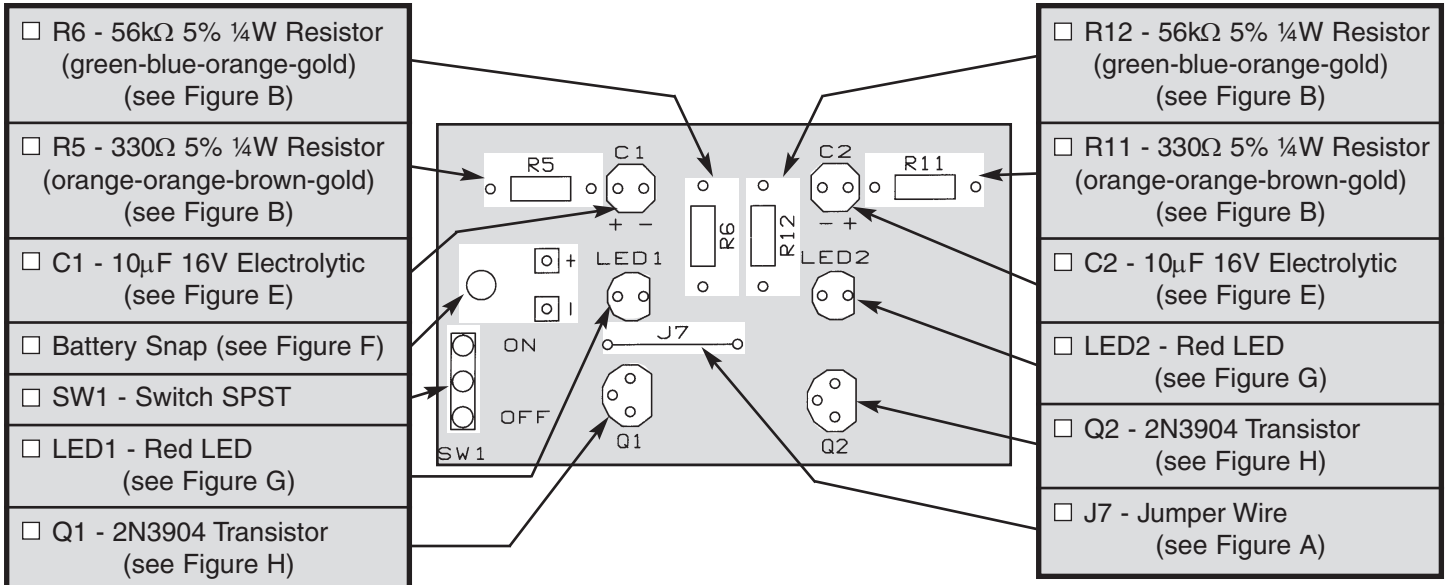

**Figure E**

Electrolytic capacitors have polarity. Be sure to mount them with the negative (-) lead (marked on side) in the correct hole.

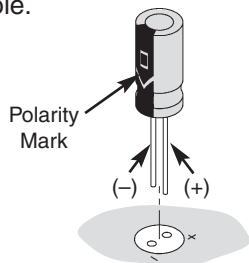

**Figure F**

Thread the battery snap wires through the hole in the PC board from the solder side as shown. Solder the red wire to the (+) point and the black wire to the (-) point on the PC board.

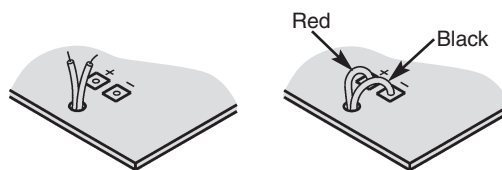

**Figure G**

Mount the LED onto the PC board with the flat side of the LED in the same direction as marked on the PC board.

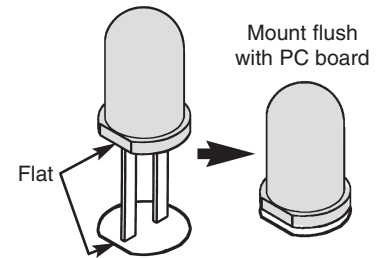

**Figure H**

Mount the IC with the flat side in the same direction as marked on the PC board. Solder and cut off the excess leads.

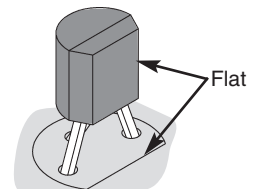

## OPERATION

Connect a 9 volt battery to the battery snap. Turn the ON/OFF switch to the ON position and the LEDs should alternately light.



---

## TROUBLESHOOTING

If you are a student, and any parts are missing or damaged, please see instructor or bookstore. If you purchased this solder practice kit from a distributor, catalog, etc., please contact Elenco® Electronics (address/phone/e-mail is at the back of this manual) for additional assistance, if needed.

If you are experiencing a problem, first read the theory of operation to familiarize yourself with the operation.

### Component Check

1. Be sure that all components have been mounted in their correct places.
2. Make sure that C1 and C2, the electrolytic capacitor is mounted correctly. The negative lead should be in the hole as shown on the top legend.
3. Have LEDs LED1 and LED2 been installed correctly? The flat side of their bodies should be in the same direction as marked on the top legend. If the LEDs are in backwards, they will not light.

4. Pay close attention to the red and black wires of the battery snap. The red wire should be installed in the positive (+) hole and the black wire in the negative (-) hole. Snap in a fresh 9-volt battery.

### Problems

#### 1. No LEDs Light

- Check the solder connections for the battery wires and switch.
- Check that all parts are in the correct way.

#### 2. LED1 Does Not Light

- Check C1, LED1 and Q1.

#### 3. LED2 Does Not Light

- Check C2, LED2 and Q2.

#### 4. LED1 or LED2 is Always On

- Check C1 and C2 for opens.
- Check Q1 and Q2 for shorts.

---

## WORD GLOSSARY

<b>Capacitor</b>	An electrical component that can store electrical pressure (voltage) for periods of time.
<b>Cold Solder Joint</b>	Occurs because insufficient heat was applied or the connection was moved before the solder had set. Connection looks crystalline, crumbly, or dull.
<b>Flux</b>	A substance that is used to cleanse the surface of oxide before it is soldered. Always used in electronics work. Most of the solder used in electronics has flux built right into it.
<b>Heat Sinking</b>	A process of keeping the component from becoming overheated during soldering. Any metal object that can be clamped to the component lead will work as an effective heat sink. An alligator clip or pliers work well.
<b>Integrated Circuit (IC)</b>	A type of circuit in which transistors, diodes, resistors, and capacitors are all constructed on a semiconductor base.
<b>Jumper Wire</b>	A wire that is connected from one place to another on a PC board, thereby making a connection between two pads.
<b>LED</b>	Common abbreviation for light emitting diode.
<b>Light Emitting Diode</b>	A diode made from gallium arsenide that has a turn-on energy so high that light is generated when current flows through it.
<b>Oxidation</b>	Most metals, when exposed to air, form an oxide on their surface which prevents solder from adhering to the metal.
<b>Polarity</b>	The division of two opposing forces or properties.
<b>Printed Circuit Board</b>	A board used for mounting electrical components. Components are connected using metal traces "printed" on the board instead of wires.

---

## WORD GLOSSARY (continued)

<b>Resistor</b>	Component used to control the flow of electricity in a circuit. It is made of carbon.
<b>Rosin Core Solder</b>	The most common type of solder used in electronics generally referred to as 63/37 rosin core solder.
<b>Solder</b>	A tin/lead alloy that melts at a very low temperature, used to join other metals together. It produces excellent electrical connections.
<b>Solder Bridge</b>	An unwanted solder connection between two points that are close together.
<b>Solder Melting Point</b>	The temperature at which a tin/lead alloy (solder) melts. The common solder used in electronics (63% tin / 37% lead) has a melting point of 361°F.
<b>Solder Wick</b>	Braided wire coated with flux to effectively remove solder from a connection.
<b>Soldering</b>	The process of joining two or more metals by applying solder to them.
<b>Tack Soldering</b>	A connection where the lead or wire does not have any mechanical support.
<b>Tinning the Tip</b>	A process of coating the soldering iron tip with solder to minimize the formation of oxide on the tip, which would reduce the amount of heat transfer.
<b>Transistor</b>	An electronic device that uses a small amount of current to control a large amount of current.
<b>Wire Gauge</b>	Refers to the size of the wire. The bigger the number, the smaller the diameter of the wire. 18 gauge to 24 gauge is generally used for hook-up in electronics.

---

## QUIZ

- Solder is comprised of what two materials?
  - A. Gold and copper
  - B. Tin and lead
  - C. Zinc and copper
  - D. Lead and aluminum
- What type of flux should be used in electronics?
  - A. Chloride
  - B. Organic
  - C. Rosin
  - D. Corrosive
- When working on PC boards, what wattage range of iron is ideal?
  - A. 15-40 watts
  - B. 50-100 watts
  - C. 1-10 watts
  - D. 100-200 watts
- Tinning the soldering tip will prevent it from . . .
  - A. heating.
  - B. melting.
  - C. soldering.
  - D. oxidizing.
- Proper solder adhesion requires that the metal surface to be . . .
  - A. solder free.
  - B. clean.
  - C. greasy.
  - D. cold.
- Solder wick is used to . . .
  - A. remove solder.
  - B. solder in small parts.
  - C. cleaning the soldering iron tip.
  - D. removing flux.
- A cold solder joint is caused by . . .
  - A. a solder bridge.
  - B. using 60/40 solder.
  - C. insufficient heat.
  - D. acid core solder.
- When two adjacent solder joints accidentally touch, it is called . . .
  - A. a jumper.
  - B. a blob.
  - C. a solder hole.
  - D. a solder bridge.
- What ratio has the greatest amount of tin?
  - A. 20/60
  - B. 40/60
  - C. 50/50
  - D. 63/37
- A good solder connection should be . . .
  - A. dull and rough.
  - B. shiny, bright and smooth.
  - C. lumped around the connection.
  - D. soldered on one side of the connection.

Answers: 1. B, 2. C, 3. A, 4. D, 5. B, 6. A, 7. C, 8. D, 9. D, 10. B

**Elenco® Electronics, Inc.**

150 Carpenter Avenue

Wheeling, IL 60090

(847) 541-3800

Website: [www.elenco.com](http://www.elenco.com)

e-mail: [elenco@elenco.com](mailto:elenco@elenco.com)